

buffet | tabletop | bar

GASTRONOMIE- UND SERVIERARTIKEL

FOOD SERVICE EQUIPMENT
EQUIPAMIENTOS PROFESIONALES
EQUIPEMENT PROFESSIONNEL



2020

SINCE 1933

„Enjoy the new APS catalogue 2020!“

APS - Mehrwert
Inspiration & Service

APS - your added value
inspiration and service

APS - su beneficio adicional
inspiración y servicio

APS - votre bénéfice supplémentaire
inspiration et service



Reinhold Pott
managing director

Johannes Becker
managing director

family-run company
since 1933

Als inhabergeführtes Unternehmen in der 4. Generation legt APS viel Wert auf Kontinuität, Innovation und Vertrauen.

As a family-run company in the 4th generation, we value continuity, innovation and trust

Como empresa familiar administrada por la 4ª generación ponemos mucho énfasis en la continuidad, la innovación y la confianza.

En tant qu'entreprise familiale gérée par la 4ème génération, nous partageons nos valeurs en termes de continuité, d'innovation et de confiance.

APS Germany



www.ovarandao.pt

www.ovarandao.pt

www.ovarandao.pt



APS head office | Sundern Germany



APS production | stainless steel trays | Made in Germany



Assheuer + Pott GmbH & Co. KG

Talweg 11 | 59846 Sundern
Germany

Phone: +49 (0) 29 33 / 97 35 - 0

E-Mail: info@aps-germany.de

aps-germany.de



YouTube

Keep in touch
aps_germany



Visit our
website!



GGKA
Bestpartner
2018|2019

serving ware & kitchen tools



S. 23



S.87



S.109

Buffet & Display



S. 154



S. 199



S. 265

Buffet & Tableware Melamin



S.269



S.315



S.339

Tableware Tablepresentation



S.354



S.368



S.379

Körbe baskets cestas corbeilles



S.382

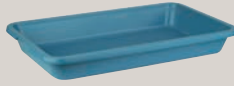

S.401



S.422

Chafing Dish, GN Container & Transport



S.429



S.438



S.479

Bar Café Drinkware



S.496



S. 511



S.518

Servier- & Küchenhelfer kitchen & serving tools herramientas de cocina outils de cuisine



S.532



S.534



S.535

Hauben & Zubehör covers & accessories

„NOVELTIES 2020 Design & Innovation“



FRIDA | S. 196



HAPPY BUFFET | S. 154 -155



S. 79



S. 84, 454



S. 109



S. 114



S. 440

*Streetfood
Style*



S. 277



S. 277



S. 429



S. 441



S. 457

**Bar
Café
Drinkware**



Super trendy



Super trendy

**Buffet & Tableware
Melamin**

 **DEUTSCH**

Artikel	Seite
A	
Abfalleimer	482-483
Abräumwagen	416-417
Abtropfmatte	458
Adapter / Zwischensteg	405
Allzweckgießer	332, 465-466
Antirutschmatte	166
Aschenbecher	478-483
Aufstrichmesser	508
Ausgießer	330, 461-462
Ausstellblech	516
Austernmesser	505
B	
Backblech	408
Backform	515
Backhandschuhe	517
Bain-Marie	382-383, 385-386, 388-396
Bar-Caddy	459
Barlöffel	448
Barmaß	445-447
Barmatte	458
Becher	437-442
Becher Emaille	279
Behälter	146-148
Bento Box	171
Beschriftungsetiketten	312
Beschriftungskarten	306
Besteckablage	259, 400
Besteckbehälter	27-28, 142-144, 146-148, 288, 300-302, 304, 341
Besteckständer	126, 147-148, 418
Besteckständer Melamin	126, 147, 418
Bestecktaschen	351
Beton	14-16, 150, 192-193, 308-310, 341, 344-346, 434, 481
Bierglasträger	62, 435, 474
Blattschale Melamin	195, 221, 250-251
Bonleiste	521
Bonspieß	521
Brennflüssigkeit	400
Brennpastenbehälter Edelstahl	399
Brezel- oder Wurstständer	59, 119
Brotstation	128, 379
Brotkorb	354-363, 367-369
Brottschneidebrett	128-129
Brötchenschütte	357
Brötchenspender Edelstahl	140
Brottasche	370-372
Buffet Kühlset	25
Buffet Kühlset Edelstahl	74-75
Buffet-Set	32, 39, 69
Buffetbrett	58-59
Buffet-Brücke	111
Buffetgestell	109-110, 112, 121, 126
Buffetleiter	122-125
Buffetschilder	308, 310, 312
Buffetständer	15, 35, 104-107, 126, 131, 199
Buffetständer Edelstahl	107, 173, 200, 377
Buffetständer Holz	15, 21, 104, 106
Buffetständer Metall	35, 105-107, 126, 173, 200
Buffetvitrine	67-68, 70-73
Buffetvitrine Edelstahl	70-73
Butter- und Saucenwärmer	294
Butterdose	334
Butterservierer	334
Bürste Bar	456

C	
Caddy	335-341
Cerealispender	27-28, 130-132
Cerealispender Edelstahl	131-132
Chafing Dish	382-393
Chafing Dish Rolltop	389-390, 392, 396
Champagnerkühler	430-431
Cocktailmesser	451, 504
D	
Dariolform	515
Deckel	26, 76-78, 124-125, 154, 168, 187, 204, 206, 215, 240, 243, 247, 254, 283, 393-395, 405-407, 410, 535-536
Deckel Edelstahl	386, 388
Dekoriermesser	451, 505
Dip-Schälchen	254-255
Dispenser Saft	27-28, 93, 95, 97-99, 101
Dispenser Saft / Milch	95, 97-98
Display	108
Dosier- & Vorratsflasche	461
Dosierer Zucker	331-333, 465-467
Dosierpumpe	524
Dosierspender	524
Dressingtopf Edelstahl	65-66
Dressingtopf Melamin	65-66
E	
Eier-Box	422
Eierbecher	259, 334
Eierkorb	372
Eierschneider	510
Eis-Kugel-Former	455
Eisbox	19, 84, 454
Eiseimer	426, 453
Eisportionierer	500
Eisschaufel	455
Eiswaffel-Ständer	522
Eiszerkleinerer	455
Emaille-Artikel	278-279, 334
Entkerner	504
Etagère	52, 113, 116, 118-119, 238
F	
Fadenschneider	503
Fast-Food Tablett	64, 423, 476
Fingerfood-Löffel	233, 260-261
Flambierbrenner	470, 510
Flaschenhalter Wein	435
Flaschenkühler	28, 426, 429-434, 437, 460
Flaschenöffner	460, 464
Flaschenträger	435
Fleisch- / Gemüseplatte	29
Folien-Abreibvorrichtung	521
Frischhaltedeckel	26, 283, 536
G	
Gabel Fleisch	412-413, 415, 488-489, 491, 495
Gabel Salat	415, 492, 494
Gebäckpalette	506
Genusspalette	53
Getränkspender	27-28, 86-102
Getränkewanne	429
Gewürzkasten	524
Gewürzmühle	314-319
Gewürzständer	329
Gläserschiene	435
Glasplatte	60, 109-110
Glasumrander	455
Glocke	483
Gourmetlöffel	296
GN Abtropfgitter	405-406
GN Behälter	401-404, 406-407, 409-411
GN Besteckbehälter	142, 361, 418

GN Buffet-Set	32
GN Buffetgestell	22-24, 110, 366
GN Buffetleiter	122-123
GN Buffetständer	173, 200
GN Buffetvitrine Edelstahl	70, 72
GN Chafing Dish	382, 385-386, 389-393
GN Deckel	404-407, 410
GN Haube	20-21, 32, 174, 190, 354, 364-365, 374, 411, 530-532
GN Konvektomatenblech	408
GN Korb	19, 374
GN Korb Metall	374
GN Korb Polypropylen	19, 354, 356, 361-364
GN Naturschieferplatte	23-24, 49-50
GN Partyplatte	40-41
GN Rost	408
GN Schale Melamin	154, 156, 158, 203, 205, 236, 240-241
GN Servierbrett	53
GN Serviergestell	120
GN Tablett	18, 24, 29, 33-34, 60-61, 160-161, 166-167, 176, 178, 181-182, 185, 187, 190, 193, 200, 204, 208, 211, 214, 218-219, 224, 232, 236, 239, 243, 248-249, 336, 409
GN Tablett Edelstahl	18, 29, 239
GN Tablett Melamin	18, 24, 60-61, 161, 166-167, 176, 178, 181-182, 185, 187, 190, 193, 200, 204, 208, 211, 214, 218-219, 224, 232, 236, 239, 243, 248-249, 336, 409
Gourmetgläser	281
H	
Haube	20-21, 32, 34, 37-38, 45-46, 48, 58-59, 104, 117, 163, 174, 190, 198, 216, 256-258, 289, 291-293, 354, 364-365, 374, 409, 411, 530-535
Haube Rolltop	37, 39, 51, 59, 69-75, 163, 258, 364, 396, 532-533
Haube Rolltop Edelstahl	396
Heizelement	94, 397-399
Hobel	59
Holzbox	57, 141, 287, 339-340
Hummerebrecher	510
Hygieneschutz	59, 119
I	
Induktionskochplatte	383-384, 386-388, 398
Isolierkanne	102-103
K	
Kaffeebecher	259
Kaffeedispenser Edelstahl	94, 102, 397
Kaffeekanne	102-103, 468
Kanne	82-83, 102-103, 467-468
Kanne Saft	82-83
Karaffe Glas	79-82
Kartenhalter	305-312
Käsehobel	505
Käseglocken-Set	39, 59
Kaviarkühler	42, 294
Kellnermesser	464
Kerzenleuchter	342-344
Konditorplatte	47-48, 216, 256-257, 290-291
Konferenzkühler	460
Korb Edelstahl	173, 364, 375-377
Korb Metall	161, 277, 373-376, 378-379
Korb Polypropylen	19, 299, 354-369, 421
Korkenzieher	464
Kronkorkenschale	460
Kugelausstecher	503
Kühlakku	26, 67-78, 81,

	87, 96, 460, 537
Kühlbox	17, 19, 25, 61, 69, 74-75
Kühlkaraffe	81
Kühlmanschette	434
Kühlschale	26, 76-78
Kühltablett	17, 71, 73
L	
Likör- und Fondanttrichter	513
Limettenpresse	452, 518
Löffel	260-261, 296, 412-415, 487-495, 500-502, 512
Löffel Backen	512
Löffel Feinkost	501
Löffel Fingerfood	233, 260-261
Löffel Frittieren	512
Löffel Gourmet	296
Löffel Salat	415, 492, 494
Löffel Saucen, Dressing	415, 493, 495, 501
Löffel Spaghetti	414, 493
M	
Magnet-Messerhalter	521
Mandoline	513
Menage	248, 323-329
Messbecher	514
Messlöffelsatz	500
Metallrahmen für Induktionskochplatte	386-388, 398
Milchgießer/-kännchen	85, 333, 467-469
Milchkanne	99-100
Minis	262-265
Moscow Mule Becher	437-439
Mühle Pfeffer	314-319
Mühle Salz	314-319
Multi Rack Edelstahl	135-136
Multibox	140
Muscheltopf	283
Müslispender	27-28, 130-132
N	
Naturschiefer	23-24, 39, 49, 50-52, 54, 118-119, 286, 288-289, 319, 475
Naturschieferplatte	23-24, 50-51, 288-289
P	
Palmbattschale Melamin	250-251
Parmesan Menage	328
Partyplatte	40-41
Pastateller Melamin	249
Pendelschäler	504
Permanent-Ausgießer	462
Pfanne	526
Pfannenwender	415, 486, 491, 494
Pfeffermühle	314-319
Pinself	518
Pinzettzange	456, 497
Pitcher	83, 435
Pizzaform	527
Pizzaschaufel	509, 517
Pizzaschneider	509
Platzsets	347-351
Platzteller	297
Pommes-Frites-Seiher	512
Porzellan	383, 388
Q	
Quetschflasche	523
R	
Rechnungstablett	313, 477
Reinigungsbürste	456-457
Rezeptionsglocke	483
Rolltop-Set	39, 51
Rührglas	461

S

Saftdispenser	27-28, 95, 97-99, 101
Saftkanne	82-83
Salzmühle	314-319
Sauciere	295
Schälchenspender	136-137
Schale Beton	14-16
Schale Edelstahl	26, 34, 276, 376
Schale Emaille	278-279, 334
Schale Holz	57, 284
Schale Melamin	26, 78, 121, 137, 154-159, 168, 175, 177, 179-180, 183-184, 186-187, 189, 191-193, 195, 198, 201-208, 212, 215, 221-223, 225-229, 231-232, 234-243, 246-255, 258, 262-265, 470
Schaufel Eis	455
Schaufel Mehl	517
Schaumlöffel	414, 487, 490-491
Schaumspesering	514
Schiefer	23-24, 39, 49-52, 54, 118-119, 286, 288-289, 319, 475
Schilder	308, 311, 536
Schlüsselschnur	463
Schneebesen	511
Schneidbrettständer	522
Schneidebrett	18, 128-129, 379, 451
Schöpflöffel	412-415, 487-490, 495
Sektkühler	426-429, 431-432
Senftöpfchen	325
Service Tower	134
Servier- / Tortenplatte Edelstahl	38, 47, 290
Servier- / Tortenplatte Holz	45, 117, 293
Servier- / Tortenplatte Melamin	46, 48, 183, 216, 256-257, 291-292
Servierbrett	53-57, 284-287, 341, 475
Serviergabel	415, 495
Serviergestell	114-116, 118-120, 282
Servierkelle	268, 471
Servierlöffel	412-415, 487-491, 494
Servierpfanne	35, 270-271, 275, 525, 526
Servierpfanne Schmiedeeisen	526
Servierpfanne Gusseisen	270-271, 525
Serviertablett	38, 42-44, 62-63, 269, 423, 472-475, 516
Servierwagen	416-417
Serviettenhalter	149-151
Serviettenringe	298
Serviettentaschen	351
Shaker	443-444
Sieb	449, 451, 511-513
Snackbox	268, 275
Snackholder	272-275
Snackpresenter	127
Sortierbox	422
Spachtel	508
Sparschäler	503
Speisenwärmer	382-391
Spießständer / Spieße	294
Spritzflasche	330, 461
Standascher	482-483
Ständer	199, 329, 428, 522
Ständer Wein- / Sektkühler	428
Staubkappen	463
Stielkasserolle	296
Stift	312
Stößel	450
Streichpalette	506
Streuer	320-322, 512
Streuer Pfeffer	314-319, 322
Streuer Salz	314-319, 322, 512
Superbox	22-24
Suppenkelle	492
Suppentopf	391, 394-396

Sushiboard Melamin	180-181, 185, 192, 207, 221, 223, 225, 230
T	
Table Caddy	146, 299, 335-336, 338-341
Tablett	18, 43-44, 62-63, 269, 313, 357, 409, 423, 472-477, 516
Tablett Edelstahl	18, 29-39, 42-44, 269, 313, 471-473, 477, 516
Tablett Fast Food	64, 423, 476
Tablett Holz	63-64, 162, 165, 336, 475, 476
Tablett Melamin	18, 24, 43, 60-62, 128, 160-161, 165-167, 176-178, 181-183, 185, 187, 190, 192-193, 199-202, 204-205, 207-211, 213-221, 223-225, 230-233, 236-241, 243-245, 248-249, 251, 258, 265, 319, 379, 472, 474
Tasse Melamin	259
Teebox	140-141
Teebrühsieb	85, 470
Teekanne ASIA	85, 467
Teigschaber / Abstecher	508
Teller Emaille	278
Teller Fingerfood	63, 194, 239, 259
Teller Melamin	63, 169, 177, 179, 180, 182, 184-185, 188, 194, 213, 222, 225, 230, 245-246, 252-253, 258-259, 264
Thermo Tablett-Set	67-68
Thermo-Set	75
Tischrestehälter	145-148, 302-304
Tischaufsteller	307, 311
Tischkartenhalter	305-310, 312
Tischkrümelentferner	147, 313, 477
Tischsets	347-350
Tortenheber	493, 495
Tortenmesser	493
Tortenplatte	38, 45-48, 117, 183, 216, 256, 257, 290-293
Tortenring	515
Transportwagen	416-417
Trenner	358
Tretbeutelhalter	483
Trinkbecher	89-93, 436
Trinkhalme	457
Tropfenschale Melamin	90-91, 93
U	
Universalbox	139-140, 524
Universalkanne	85, 468, 514
Untersetzer Edelstahl	298
Untersetzer Kork	89-92, 526
Untersetzer Naturschiefer	51, 289, 319
V	
Vase	346
Verschluss	462-463
Verschluss Wein / Champagner	462
Vorratsglas	138-139, 519-520
W	
Wachspapier	53, 269, 275
Wanne	18, 84, 423, 429
Warenträger	40, 347
Wärme-Kies	400
Warnschild	527, 537
Wasserbadschüssel	513
Wasserspender	86-93, 97
Weck Gläser	280-282
Wein-Vakuum-Pumpe	463
Weinkühler	426-429, 431-432
Weinkühlerständer	428
Weinpumpe-Ersatzstopfen	463
Wender	413-415, 486, 489-491, 494, 506, 507
Windaschenbecher	478-481
Windlicht	345

Z

Zange	456, 487, 496-500
Ziseliermesser	503
Zitronenschnitzelpresse	470
Zitruspresse	451, 518
Zitrusteiler	452
Zuckerdosierer	331-333, 465-467
Zuckerkugel	333, 470
Zuckerspender	333, 467
Zuckertüten-Box Edelstahl	469
Zutatenbehälter	459

buffet ladder	122-125
buffet set	32, 39, 69
buffet signs	308, 310, 312
buffet stand	15, 35, 104-107, 126, 109-110, 112, 121, 131, 199
buffet stand chrome plated steel	35, 105-107, 126, 173, 200
buffet stand stainless steel	107, 173, 200, 377
buffet stand wood	15, 21, 104, 106
Buffett-board	58-59
butter and sauce pan warmer	294
butter dish	334

C

caddy	335-341
cake lifter	493, 495
cake plate melamine	46, 48, 183, 216, 256-257, 291-292
cake plate stainless steel	38, 47, 290
cake plate wood	45, 117, 293
cake setting ring	515
cake slice	493
cake stand	38, 45-48, 117, 183, 216, 256-257, 290-293
candle holder	342-344
canele / decorating knife	503
canister with lid	138-139, 519-520
cap bowl	460
cast iron pan	270-271, 525
caviar cooler	42, 294
cereal dispenser	27-28, 130-132
cereal dispenser stainless steel	131-132
Chafing Dish	382-393
Chafing Dish Rolltop	389-390, 392, 396
champagne bowl	426-429, 431-432
champagne saver	462
cheese dish	328
cheese slicer	505
chefs blow torch	470, 510
chopping board	18, 128-129, 379, 451
citrus squeezer	451, 518
citrus wedger	452
cleaning brush	456-457
clingfilm tear-off dispenser	521
cloche / dome cover	483
coaster cork, wood	89-92, 526
coaster natural slate	51, 289, 319
coaster stainless steel	298
coffee cup	259
coffee dispenser stainless steel	94, 102, 397
coffee pot	102-103, 468
condiment container	524
condiment holder	459
confectionery funnel	513
conference bottle cooler	460
container	18, 84, 146-148, 423, 429
cool collar	434
cooler	26, 67-78, 81, 87, 96, 460, 537
cooling bowl	26, 76-78
cooling box	17, 19, 25, 61, 69, 74-75
cooling carafe	81
cooling plates	17, 71, 73
corer	504
corkscrew	464
cornet stand	522
cover	20-21, 26, 32, 34, 37-38, 45-46, 48, 58-59, 76-78, 104, 117, 124-125, 154, 163, 168, 174, 187, 190, 198, 206, 215-216, 240, 243, 247, 254, 256-258, 283, 289, 291-293, 354, 364-365, 374, 405-407, 409-411, 530-536

 **ENGLISH**

item	page
A	
adapter	405
airtight cover	26, 283, 536
ashtray	478-483
B	
bain marie bailing bowl	513
bain marie	382-383, 385-386, 388-396
baking mittens	517
baking pan	515
baking sheet	408
bar caddy	459
bar knife	451, 504
bar shaker	443-444
bar spoon	448
barrel mug	437-442
basket metal	161, 277, 373-376, 378-379
basket polypropylene	19, 299, 354-369, 421
basket stainless steel	173, 364, 375-377
beaker	279
beer rack	62, 435, 474
Bento Box	171
beverage dispenser	27-28, 86-102, 459
beverage tub	429
bill presenter	313, 477
bill rail	521
bill spike	521
bottle cooler	28, 426, 429-434, 437, 460
bottle fuel	399
bottle opener	460, 464
bottle rack	435
bowl concrete	14-16
bowl enamel	278-279, 334
bowl holder	136-137
bowl melamine	26, 78, 121, 137, 154-159, 168, 175, 177, 179, 180, 183-184, 186-187, 189, 191-193, 195, 198, 201-208, 212, 215, 221-223, 225-229, 231-232, 234-243, 246-255, 258, 262-265, 470
bowl stainless steel	26, 34, 276, 376
bowl wood	57, 284
bread basket	370-372
breadbox	354-363, 367-369
brush	518
buffet bridge	111

cover stainless steel	386, 388
crumber	147, 313, 477
cup melamine	259
curler	59
cutlery	14-16, 150, 192-193, 308-310, 341, 344-346, 434, 481
cutlery bag	351
cutlery basket	126, 147-148, 418
cutlery basket melamine	126, 147, 418
cutlery organizer	27-28, 142-144, 146-148, 288, 300-302, 304, 341
cutlery rest	259, 400
cutting board	128, 129
cutting board rack	522
D	
dariol moulds	515
decorating knife	451, 505
decorator / zester	503
delicatessen spoon	501
designation cards	306
dip bowl	254-255
dispenser	27-28, 86-102
dispenser dosing	524
dispenser sugar	331-333, 465-467
display	40, 108, 347
display tray	516
dosing pump	524
dough scraper	508
dressing pot melamine	65-66
dressing pot stainless steel	65-66
dressing/sauce spoon	415, 493, 495, 501
drinking cups	89-93, 436
drip mat	458
drip tray	90-91, 93
dust & fly cap	463
E	
egg basket	372
egg cutter	510
egg holder	259, 334
eggs box	422
enamel	278-279, 334
F	
fingerfood plate	63, 194, 239, 259
flower vase	346
fork	415, 495
frame for induction plate	386-388, 398
free flow pourer	462
fry dripping tray	512
G	
glass carafe	79-82
glass plate	60, 109-110
glass rack	435
glass rimmer	455
GN 1/1 buffet set	32
GN 1/1 dispenser	142, 361, 418
GN basket	19, 374
GN basket metal	374
GN basket polypropylene	19, 354, 356, 361-364
GN bowl, square melamine	154, 156, 158, 203, 205, 236, 240-241
GN buffet ladder	122-123
GN buffet stand	22-24, 110, 173, 200, 366
GN Chafing Dish	382, 385-386, 389-393
GN cover	20-21, 32, 174, 190, 354, 364-365, 374, 411, 530-532
GN grid	408
GN natural slate tray	23-24, 49-50
GN partytray	40-41
GN refrigerated buffet display	70, 72
GN serving board	53
GN serving stand	120

GN tray	18, 24, 29, 33-34, 60-61, 160-161, 166-167, 176, 178, 181-182, 185, 187, 190, 193, 200, 204, 208, 211, 214, 218-219, 224, 232, 236, 239, 243, 248-249, 336, 409
GN tray melamine	18, 24, 60-61, 161, 166-167, 176, 178, 181-182, 185, 187, 190, 193, 200, 204, 208, 211, 214, 218-219, 224, 232, 236, 239, 243, 248-249
GN tray stainless steel	18, 29, 239
GN-container	401-404, 406-407, 409-411
GN-convection oven trays	408
GN-drainer	405-406
GN-lid	404-407, 410
gourmet glasses	281
graduated jug	514
granite chips	400
gravy boat	295
greaseproof paper squares	53, 269, 275
H	
heating unit	94, 397-399
hygienic cover	59, 119
I	
ice ball former	455
ice box	19, 84, 454
ice bucket	426, 453
ice cream scoop	500
ice crusher	455
ice scoop	455
induction plate	383-384, 386-388, 398
J	
jigger	445-447
jug	85, 468, 514
juice and milk dispenser	95, 97-98
juice dispenser	27-28, 93, 95, 97-99, 101
juice pitcher	82-83
K	
key cord	463
L	
labeling labels	312
labels	308, 311, 536
ladle	412-415, 487-490, 495
leaf melamine	195, 221, 250-251
lemon slice squeezer	470
lime press	452, 518
lobster cracker	510
M	
magnetic knife rack	521
mandolin	513
meat platter	400
meatfork	412-413, 415, 488-489, 491, 495
melon baller	503
menage	248, 323-329
milk dispenser	99-100
milk jug	85, 333, 467-469
mini bowl	262-265
mixing glass	461
Moscow Mule barrel mug	437-439
mousse ring	514
muddler	450
multi rack stainless steel	135-136
multibox	140
mussel pot	283
mustard glass	325
N	
napkin bag	351
napkin holder	149-151
napkin rings	298
natural slate	23-24, 39, 49-52, 54, 118-119, 286, 288-289, 319, 475

natural slate tray	23-24, 50-51, 288-289
non slip mat	166
O	
oyster knife	505
P	
palm leaf melamine	250-251
pan	35, 270-271, 275, 525-526
paring knife	358
party spoon	233, 260-261, 296
partytray	40-41
pasta plate melamine	249
pastry spatula	506
pedal bin	483
peeler	503
pen	312
pepper mill	314-319, 322
pitcher	82-83, 102-103, 435, 467-468
pizza cutter	509
pizza dish	527
pizza peel	509, 517
placemat	347-350
plate enamel	278
plate melamine	63, 169, 177, 179-180, 182, 184-185, 188, 194, 213, 222, 225, 230, 245-246, 252-253, 258-259, 264
plate tray	297
plate warmer	382-391
porcelain	383, 388
pourer	332, 465-466
pourer cleaning brush	456
pourers	330, 461-462
pouring container	461
pretzel-/ sausage stand	59, 119
R	
refrigerated buffet display	25
refrigerator butter dish	334
ring bell	483
roll / bun basket	357
roll dispenser stainless	140
rolltop cover	37, 39, 51, 59, 69-75, 163, 258, 364, 396, 532-33
rolltop set	37, 39, 51, 59
rolltop-cover stainless steel	396
S	
salad fork	415, 492, 494
salad spoon	415, 492, 494
salt mill	314-319, 322, 512
sandwich knife	508
sauté pan / mini sauce pan	296
scoop	517
scraper	508
service tower	134
service trolley	416-417
serving board	53-57, 284-287, 341, 475
serving cup	272-275
serving spoon	412-415, 487-491, 494
serving stand	114-116, 118-120, 199, 282, 329, 428, 522
serving stand/rack	329
serving trolley	388-389, 416-417
serving trowel	268, 471
set measuring spoon	500
shaker	320-322, 512
shape sorter	422
showcase	67-68, 70-73
showcase stainless steel	70-73
skewer rack/skewer	294
skimmer	414, 487, 490-491
skimmer spoon	512
slate	23-24, 39, 49-52, 54, 118-119, 286, 288-289, 319, 475
snack tray	64, 423, 476

snackbox	268, 275
snackpresenter	127
snap mesh tea ball	85, 470
soup ladle	492
soup pot	391, 394-396
spaghetti spoon	414, 493
spatula	506
spice mill	314-319
spider spoon	512
spoon	260-261, 296, 412-415, 487-495, 500-502, 512
squeeze bottle	330, 461, 523
stand for wine / champagne bowl	428
standing ashtray	482-483
strainer	449, 451, 511-513
straws	457
sugar dispenser	331-333, 465-467
sugar pocket holder	469
sugar pot	333, 470
superbox	22-24
sushiboard melamine	180-181, 185, 192, 207, 221, 223, 225, 230
swivel peeler	504
T	
table caddy	146, 299, 335-336, 338-341
table garbage bin	145-148, 302-304
table stands	305-312
tea-box	140-141
teapot ASIA	85, 467
thermo set	75
thermo tray	67-68
tong	456, 487, 496-500
tray	18, 29, 38, 42-44, 52, 62-63, 113, 116, 118-119, 238, 269, 313, 357, 409, 423, 472-477, 516
tray melamine	18, 24, 43, 60-62, 128, 160-161, 165-167, 176-178, 181-183, 185, 187, 190, 192-193, 199-202, 204-205, 207-211, 213-221, 223-225, 230-233, 236-241, 243-245, 248-249, 251, 258, 265, 319, 379, 472, 474
tray stainless steel	18, 29-39, 42-44, 269, 313, 471-473, 477, 516
tray wood	63-64, 162, 165, 336, 475-476
turner	413-415, 486, 489-491, 494, 506-507
tweezer	456, 497
U	
universal box	139-140, 524
V	
vacuum jug	102-103
vacuum wine pump	463
W	
waiter's corkscrew	464
Weck-bottles	280-282
whisk	511
wind lights	345
wine bowl	426-429, 431-432
wine pump stopper	463
winebottle-stand	435
woodbox	57, 141, 287, 339-340
wrought-iron pan	526

 **ESPAÑOL**
artículos **pág.**

A	
abre ostras	505
abridor	460, 464
acumulador de frío	26, 67-78, 81, 87, 96, 460, 537
adaptador	405
aro anti-goteo	90-91, 93
aro de tarta	515
aro redondo para semifríos	514
azucarero	331-333, 465-467, 470
azucarero para bolsitas	469
B	
bano maría	382-383, 385-386, 388-396
bajo plato	297
bandeja	18, 38, 42-44, 52, 62-63, 113, 116, 118-119, 238, 269, 313, 357, 409, 423, 472-477, 516
bandeja acero inoxidable	18, 29-39, 42-44, 269, 313, 471-473, 477, 516
bandeja autoservicio y snacks	64, 423, 476
bandeja de pizarra natural	2324, 39, 49-52, 54, 118-119, 286, 288-289, 319, 475
bandeja de vidrio	60, 109-110
bandeja isotérmica	75
bandeja madera	63-64, 162, 165, 336, 475-476
bandeja melamina	18, 24, 43, 60-62, 128, 160-161, 165-167, 176-178, 181-183, 185, 187, 190, 192-193, 199-202, 204-205, 207-211, 213-221, 223-225, 230-233, 236-241, 243-245, 248-249, 251, 258, 265, 319, 379, 472, 474
bandeja para sushi melamina	180-181, 185, 192, 207, 221, 223, 225, 230
bandeja party	40-41
bandeja pastelería	408, 516
bandeja tartas acero inoxidable	38, 47, 290
bandeja tartas madera	45, 117, 293
bandeja tartas melamina	46, 48, 183, 216, 256-257, 291-292
bandeja termo	67-68
bandejas refrigeradas	17, 71, 73
barra magnética para cuchillos	521
barreño botellines	429
batidor	511
bento box	171
bol refrigerado	26, 76-78
bolsa cubiertos	351
bomba de salsa	524
bomba de vacío para vino	463
bote con tapa	138-139, 519-520
bote dosificador flexible	523
bote vertedor universal	332, 465-466
botella „store & pour“	461
botella de combustible líquido	399
botella exprimible	330, 461
brocha	518
C	
caballetes de mesa	307, 311
cacerola	526
caddy de mesa	146, 299, 335-341
cafetera	102-103, 468
caja de pan para buffet	354-363, 367-369
caja dispensadora	139-140, 524
caja madera	57, 141, 287, 339-340
caja para huevos	422
caja para té	140-141
caja surtida	422
cajón para cubiertos	27-28, 142-144, 146-148, 288, 300-302, 304, 341, 418
calentador de mantequilla y salsa	294
calienta platos	382-391
campana	20-21, 32, 34, 37-38, 45-46, 48, 58-59, 104, 117, 163, 174, 190, 198, 216, 256-258, 289, 291-293, 354, 364-365, 374, 409, 411, 530-535
campana abatible	37, 39, 51, 59, 69-75, 163, 258, 364, 396, 532-533
campana esférica	483
campana rolltop	396
candelabro	342-344
carro de servicio	416-417
cazo para baño maría	513
cazo recto bajo	96
cenicero	478-483
cenicero de pie	482-483
cepillo de limpieza	456-457
cesta acero inoxidable	173, 364, 375-377
cesta de huevos	372
cesta metal	161, 277, 373-376, 378-379
cesta para bollos	357
cesta para cubiertos	126, 147-148
cesta para cubiertos melamina	126, 147, 418
cesta polipropileno	19, 299, 354-369, 421
Chafing Dish	382-393
Chafing Dish Rolltop	389-390, 392, 396
coctelera	443-444
colador	449, 451, 511-513
conjunto aperitivo	248, 323-329
corta huevos	510
corta pasta	508
cortador de cítricos	452
cortador de pizza	509
cupeta	18, 84, 423, 429
cubierta higiénica antialiento	59, 119
cubiertos	14-16, 150, 192-193, 308-310, 341, 344-346, 434, 481
cubitera	19, 84, 454
cubitera isotérmica	426, 453
cubitera para vino y cava	426-429, 431-432
cubo champañera	430-431
cuchara	260-261, 296, 412-415, 487-495, 500-502, 512
cuchara de espaguetis	414, 493
cuchara gourmet	296, 501
cuchara para ensalada	415, 492, 494
cuchara para helado	500
cuchara para servir	412-415, 487-491, 494
cuchara party	233, 260-261
cucharilla de cóctel	448
cucharón	412-415, 487-490, 495
cucharón de salsa/alino	415, 493, 495, 501
cucharón de sopa	492
cuchillo acanalador	451, 505
cuchillo curvado	358
cuchillo de decoración cincelador	503
cuchillo para cóctel	451, 504
cuchillo para untar	508
cuenco acero inoxidable	26, 34, 276, 376
cuenco esmalte	278-279, 334
cuenco hormigón	14-16
cuenco madera	57, 284
cuenco melamina	26, 78, 121, 137, 154-159, 168, 175, 177, 179-180, 183-184, 186-187, 189, 191-193, 195, 198, 201-208, 212, 215, 221-223, 225-229, 231-232, 234-243, 246-255, 258, 262-265, 470
cuenco mini	262-265
cuenco para chapas	460
cuenco para dip	254-255
D	
dispensador	27-28, 86-102
dispensador de bebidas	27-28, 86-102, 459
dispensador de bocadillos	127
dispensador de café acero inoxidable	94, 102, 397
dispensador de cereales	27-28, 130-132
dispensador de cereales acero inoxidable	131-132
dispensador de especias	459
dispensador de film	521
dispensador de leche	99-100
dispensador de panecillos acero inoxidable	140
dispensador de salsa	524
dispensador de zumo	27-28, 93, 95, 97-99, 101
dispensador en escalera	122-125
dispensador en escalera acero inoxidable	135-136
dispensador mixto zumo y leche	95, 97-98
E	
embudo dosificador	513
enfriador de botellas	28, 426, 429-434, 437, 460
enfriador de caviar	42, 294
enfriador múltiple	460
escurridor de fritos	512
esmalte	278-279, 334
espátula	413-415, 486, 489-491, 494, 506-507
espátula plancha	508
especiero	524
espumadera	414, 487, 490-491
espumadera para fritos	512
esterilla antideslizante	166
esterilla escurridora	458
estructura o marco para placa de inducción	386-388, 398
etiquetas	308, 311-312, 536
expositor	40, 108, 347
expositor buffet	109-110, 112, 121, 126
expositor buffet frío	17, 19, 25, 61, 69-70, 72, 74-75
expositor de buffet	15, 35, 104-107, 126, 131, 199
expositor de buffet acero inoxidable	107, 173, 200, 377
expositor de buffet cromado	35, 105-107, 126, 173, 200
expositor de buffet madera	15, 21, 104, 106
exprimidor cítricos	451, 518
F	
flaneras	515
florero	346
fuelle de servicio	29
fuelle en forma de hoja melamina	195, 221, 250-251
fuelle para la mesa	35, 270-271, 275, 525-526
fuelle servicio	400

funda de frío 434

G

GN 1/1 dispensador de cubiertos	142, 361, 418
GN 1/1 set de buffet	32
GN bandeja	18, 24, 29, 33-34, 60-61, 160-161, 166-167, 176, 178, 181-182, 185, 187, 190, 193, 200, 204, 208, 211, 214, 218-219, 224, 232, 236, 239, 243, 248-249, 336, 409
GN bandeja acero inoxidable	18, 29, 239
GN bandeja de pizarra natural	23-24, 49-50
GN bandeja melamina	18, 24, 60-61, 161, 166-167, 176, 178, 181-182, 185, 187, 190, 193, 200, 204, 208, 211, 214, 218-219, 224, 232, 236, 239, 243, 248-249
GN bandeja party	40-41
GN campana	20-21, 32, 174, 190, 354, 364-365, 374, 411, 530-532
GN cesta	19, 374
GN cesta metal	374
GN cesta polypropileno	19, 354, 356, 361-364
GN Chafing Dish	382, 385-386, 389-393
GN cubeta	401-404, 406-407, 409-411
GN cubeta para hornos de convección	408
GN cuenco cuadrado melamina	154, 156, 158, 203, 205, 236, 240-241
GN escurridor	405-406
GN rejilla	408
GN soporte buffet	120
GN soporte para buffet	173, 200
GN tabla de servir	53
GN tapa	404-407, 410
granulado térmico	400
H	
huevera	259, 334
I	
infusor de té, pinza con malla	85, 470
J	
jarra	82-83, 85, 102-103, 435, 467-468, 514
jarra de leche	85, 333, 467-469
jarra de vidrio	79-82
jarra de zumo	82-83
jarra fría	81
jarra graduada	514
jarra termo	102-103
juego de cucharas medidoras	500
L	
lavero enrollable	463
M	
mandolina	513
manoplas de panadero	517
mantelín	347-350
mantequillera	334
mantequillera para nevera	334
marco pastelero	515
medidor jigger	445-447
mejillonera	283
molde de cubitos de hielo esféricos	455
molde de pizza	527
molinillo de pimienta	314-319, 322
molinillo de sal	314-319, 322, 512
molino de la especia	314-319
mortero	450
Moscow Mule taza	437-439
multibox	140

O	
olla para buffet	391, 394-396
organizador de bar	459
P	
pajás	457
pala	517
pala de hielo	455
pala de pizza	509, 517
pala de tartas	493, 495
paleta para servir	268, 471
paleta pastelera	506
panera	370-372
papel alimenticio	53, 269, 275
papelera de sobremesa	145-148, 302-304
pelador reversible	503-504
picadora de hielo	455
pie porta champañera / vino	428
piezas indicadores buffet	308, 310, 312
pinchanotas	521
pinza	456, 487, 496-500
pinza bogavante	510
pinza de emplatar	456, 497
pinza exprime limón	470
pizarra	23-24, 39, 49-52, 54, 118-119, 286, 288-289, 319, 475
placa de inducción	383-384, 386-388, 398
plato esmalte	278
plato melamina	63, 169, 177, 179-180, 182, 184-185, 188, 194, 213, 222, 225, 230, 245-246, 252-253, 258-259, 264
plato para el aperitivo	63, 194, 239, 259
plato para pasta melamina	249
polvoreador	320-322, 512
porcelana	383, 388
porcionador de pastel	493
porta botellas	435
porta cuenta	313, 477
porta vasos de cerveza	62, 435, 474
porta-etiquetas	305-310, 312
portafichas	521
portatarjetas	305-312
portavelas antiviento	345
posavasos acero inoxidable	298
posavasos corcho, madera	89-92, 526
posavasos pizarra natural	51, 289, 319
prensa de limón	452, 518
punteo de buffet	111
Q	
quesera parmesano	328
quita-rabillo	504
R	
rack de copas	435
rack dispensador para bols	136-137
rebanador de queso	505
recipiente organizador	146-148
recogemigas	147, 313, 477
reposa cuchara	259, 400
resistencia	94, 397-399
ribeteador de vasos	455
rizador	59
rotulador	312
S	
sacacorchos	464
sacacorchos de camarero	464
salsera	295
salsera acero inoxidable	65, 66
salsera melamina	65, 66
sartén de hierro fundido	270, 271, 525
sartén forjada	526
service tower	134
servilletero	149-151
servilleteros	298
set de buffet	32, 39, 69
set de buffet refrigerado	25
set rolltop	37, 39, 51, 59
snackbox	268, 275
soplete de cocina para flambear	470, 510
soporte	199, 329, 428, 522
soporte a pedal	483
soporte cucuruchos	522
soporte para botella de vino	435
soporte para brochetas	294
soporte para buffet	22-24, 110, 366
soporte para embutidos	59, 119
soporte para pastel	38, 45-48, 117, 183, 216, 256-257, 290-293
soporte para tablas	522
soporte platos	114-116, 118-120, 282
soporte salsas y condimentos	329
superbox	22-24
T	
tabla de corte	128-129
tabla de servir	53-57, 284-287, 341, 475
tabla para cortar	18, 128-129, 379, 451
tabla para el buffet	58-59
tapa	26, 76-78, 124-125, 154, 168, 187, 204, 206, 215, 240, 243, 247, 254, 283, 405-407, 410, 535-536
tapa de acero inoxidable	386, 388
tapa hermética	26, 283, 536
tapete escurridor	458
tapón antipolvo	463
tapón vertedor	462
tapones al vacío para el vino	463
tarjetas	306
tarros gourmet	281
taza	437-442
taza de café	259
taza melamina	259
tenedor de carne	412-413, 415, 488-489, 491, 495
tenedor de servicio	415, 495
tenedor de servicio para ensalada	415, 492, 494
tetera ASIA	85, 467
timbre	483
V	
vaciador de melón redondo	503
vaso coctelero	279
vaso mezclador vertedor	461
vaso para servir	272-275
vasos	89-93, 436
vasos mostaza	325
vertedor continuo	462
vertedores	330, 461-462
vitrina de buffet	67-68, 70-73
W	
Weck-botellas	280-282

FRANÇAIS

item	pág.
A	
accumulateur de froid	26, 67-78, 81, 87, 96, 460, 537
adaptateur	405
anneau coupe-gouttes	90-91, 93
anneaux à serviettes 2	98
ardoise	23-24, 39, 49-52, 54, 118-119, 286, 288-289, 319, 475
assiette creuse mélamine	249
assiette de présentation	297
assiette émail	278
assiette mélamine	63, 169, 177, 179-180, 182, 184-185, 188, 194, 213, 222, 225, 230, 245-246, 252-253, 258-259, 264
assiette pour apéritif	63, 194, 239, 259
B	
bac	18, 84, 423, 429
bac à couverts	27-28, 142-144, 146-148, 288, 300-302, 304, 341
bain-marie	382-383, 385-386, 388-396
barre aimantée pour couteaux	521
barre porte-bons	521
base bois	57, 141, 287, 339-340
bassine à glace	429
Bento Box	171
beurrer	334
boîte à beurre pour le frigo	334
boîte à épices ou ingrédients	524
boîte à fruits et ingrédients	459
boîte à œufs	422
boîte à pain pour le buffet	354-363, 367-369
boîte à thés et infusions	140-141
boîte de tri	422
boîte distributrice	139-140, 524
bol béton	14-16
bol bois	57, 284
bol couvercle inox	26, 34, 276, 376
bol émail	278-279, 334
bol mélamine	26, 78, 121, 137, 154-159, 168, 175, 177, 179-180, 183-184, 186-187, 189, 191-193, 195, 198, 201-208, 212, 215, 221-223, 225-229, 231-232, 234-243, 246-255, 258, 262-265, 470
bol mélangeur	279
bol mini	262-265
bol récupérateur de capsules	460
bol réfrigéré	26, 76-78
bordeur à verres	455
bouchon à vide pour le vin	463
bouchon anti-poussières et anti-insectes	463
bouchons verseurs	330, 461-462
boule à thé avec pince	85, 470
bouteille „store & pour“	461
bouteille de combustible liquide	399
bouteille isotherme	102-103
bouteille verseuse souple	523
brosse lave	456-457
broyeur à glaçons	455
C	
caddy de table	146, 299, 335-336, 338-341
cadre support inox pour plaque induction	386-388, 398
caisson thermo	67-68
carafe en verre	79-82
casserole	526
casserole à moules	283
cendrier	478-483
cendrier sur pied	482-483
cercle à gâteaux	515
cercle à mousse rond	514
Chafing Dish	382-393
Chafing Dish Rolltop	389-390, 392, 396
chalumbeau e cuisine	470, 510
chandelier	342-344
chariot de service	416-417
chauffe-plat	382-391
chevalets de table	307, 311
cloche	20-21, 32, 34, 37-38, 45-46, 48, 58-59, 104, 117, 163, 174, 190, 198, 216, 256-258, 289, 291-293, 354, 364-365, 374, 409, 411, 530-535
cloche basculante	37, 39, 51, 59, 69-75, 163, 258, 364, 396, 532-533
cloche demi-sphère	483
cloche rolltop	396
coquetier	259, 334
corbeille	370-372
corbeille à petits pains	357
corbeille acier inox	173, 364, 375-377
corbeille métal	161, 277, 373-376, 378, 379
corbeille polypropylène	19, 299, 354-369, 421
coupe-agrumes	452
coupe-œufs	510
coupe-pâte	508
coupe-pizza	509
couteau à huitres	505
couteau à tarte	493
couteau à tartiner	508
couteau cannelé	451, 505
couteau cocktail	451, 504
couteau d'office bec d'oiseau	358
couteau tranche-fromage	505
couteau zesteur	503
couteau zesteur cannelé	503
couvercle	26, 76-78, 124-125, 154, 168, 187, 204, 206, 215, 240, 243, 247, 254, 283, 405-407, 410, 535-536
couvercle acier inox	386, 388
couvercle hermétique	26, 283, 536
couverts	14-16, 150, 192-193, 308-310, 341, 344-346, 434, 481
cuillère	260-261, 296, 412-415, 487-495, 500-502, 512
cuillère à cocktail	448
cuillère à glace	500
cuillère à salade	415, 492, 494
cuillère à sauce	415, 493, 495, 501
cuillère à spaghettis	414, 493
cuillère de service	412-415, 487-491, 494
cuillère gourmet	296, 501
cuillère party	233, 260-261
D	
décapulateur	460, 464
dérouleur de film	521
distributeur	27-28, 86-102
distributeur à jus de fruit	27-28, 93, 95, 97-99, 101
distributeur à lait	99-100
distributeur de boissons	27-28, 86-102, 459
distributeur de café acier inox	94, 102, 397
distributeur de céréales	27-28, 130-132
distributeur de céréales acero inox	131, 132

distributeur de petits pains acier inox	140
distributeur mixte à lait et à jus de fruit	95, 97-98
doseur à sauce	524
E	
écumoire	414, 487, 490-491
écumoire à friture	512
égouttoir à couverts	126, 147-148, 418
égouttoir à couverts mélamine	126, 147, 418
égouttoir à friture	512
émail	278-279, 334
entonnoir à piston	513
équeuteur	504
étagère	52, 113, 116, 118-119, 238
étiquettes	306, 308, 311-312, 536
F	
flacon pulvérisateur	330, 461
forme à gateaux	515
fouet	511
fourchette à viande	412-413, 415, 488-489, 491, 495
fourchette de service	415, 495
fourchette de service pour la salade	415, 492, 494
frisette	59
G	
gants de boulanger	517
GN 1/1 bac à couverts	142, 361, 418
GN 1/1 set catering: plateau + cloche	32
GN bac	401-404, 406-407, 409-411
GN bac pour fours à convection	408
GN bol carré mélamine	154, 156, 158, 203, 205, 236, 240-241
GN Chafing Dish	382, 385-386, 389-393
GN cloche	20-21, 32, 174, 190, 354, 364-365, 374, 411, 530-532
GN corbeille	19, 374
GN corbeille métal	374
GN corbeille polypropylène	19, 354, 356, 361-364
GN couvercle	404-407, 410
GN égouttoir	405-406
GN grille	408
GN planche de service	53
GN plat ardoise naturelle	23-24, 49-50
GN plateau	18, 24, 29, 33-34, 60-61, 160-161, 166-167, 176, 178, 181-182, 185, 187, 190, 193, 200, 204, 208, 211, 214, 218-219, 224, 232, 236, 239, 243, 248-249, 336, 409
GN plateau acier inox	18, 29, 239
GN plateau mélamine	18, 24, 60-61, 161, 166-167, 176, 178, 181-182, 185, 187, 190, 193, 200, 204, 208, 211, 214, 218-219, 224, 232, 236, 239, 243, 248-249
GN plateau party	40-41
GN présentoir buffet	173, 200
GN support buffet	120
gobelet	437-442
gobelet à apéritif	272-275
gobelets	89-93, 436
gravier thermique	400
H	
housse isotherme	434
J	
jeu de cuillère à mesure	500

L	
louche	412-415, 487-490, 495
louche de service	492
M	
mandoline	513
marmite de buffet	391, 394-396
mesure jigger	445-447
Moscow Mule gobelet	437-439
moule à boule ronde simple	503
moule à glaçons en boules	455
moule à pizza	527
moules à flan	515
moulin à épices	314-319
moulin à poivre	314-319, 322
moulin à sel	314-319, 322, 512
multibox	140
O	
organisateur „bar caddy“	459
P	
pailles	457
panier à œufs	372
papier alimentaire	53, 269, 275
pare-haleine	59, 119
peleur	503
pelle à farine	517
pelle à gâteau	493, 495
pelle à glaçons	455
pelle à pizza	509, 517
petits chevalets de buffet	308, 310, 312
pichet	82-83, 85, 102-103, 435, 467-468, 514
pichet à café	102-103, 468
pichet à eau ou lait	85, 333, 467-469
pichet à jus de fruit	82-83
pichet gradué	514
pichet rafraîchisseur	81
pied pour seau à champagne / vin	428
pilon muddler	450
pince	456, 487, 496-500
pince à dresser	456, 497
pince à homard	510
pince presse citron	470
pinceau pâtissier	518
pique-bons	521
planche à découper	18, 128, 129, 379, 451
planche à découper buffet	58-59
planche de service	53-57, 284-287, 341, 475
plaque à induction	383-384, 386-388, 398
plaque à pâtisserie	408, 516
plat à gâteau acier inox	38, 47, 290
plat à gâteau bois	45, 117, 293
plat à gâteau mélamine	46, 48, 183, 216, 256-257, 291-292
plat à sauter	296
plat ardoise naturelle	23-24, 39, 49-52, 54, 118-119, 286, 288-289, 319, 475
plat ardoise naturelle	23-24, 50-51, 288-289
plat de service	29, 400
plat pour la table	35, 270-271, 275, 525-526
plateau	18, 38, 42-44, 62-63, 269, 313, 357, 409, 423, 472-477, 516
plateau bois	63-64, 162, 165, 336, 475-476
plateau buffet froid	70, 72
plateau couvercle inox	18, 29-39, 42-44, 269, 313, 471-473, 477, 516
plateau feuille mélamine	195, 221, 250-251

plateau mélamine	18, 24, 43, 60-62, 128, 160-161, 165-167, 176-178, 181-183, 185, 187, 190, 192, 193, 199-202, 204, 205, 207-211, 213-221, 223-225, 230-233, 236-241, 243-245, 248-249, 251, 258, 265, 319, 379, 472, 474
plateau party	40-41
plateau self-service et snacks	64, 423, 476
plateau sous-verre acier inox	298
plateau sushi mélamine	180-181, 185, 192, 207, 221, 223, 225, 230
plateau verre	60, 109, 110
plateaux réfrigérés	17, 71, 73
plucheur droitier/gaucher	504
pochette couverts	351
poêle à frire forgée	526
poêle en fonte	270-271, 525
pompe à sauce	524
pompe à vide pour le vin	463
pont de buffet	111
porcelaine	383, 388
porte condiments et sauces	329
porte verres à bière	62, 435, 474
porte-addition	313, 477
porte-bols	136-137
porte-bougies anti-vent	345
porte-bouteilles	435
porte-cartes	305-312
porte-clés avec câble à enroulement	463
porte-étiquettes à pince	305-310, 312
porte-sachets de sucre	469
porte-serviettes	149-151
pose-cuillère	259, 400
pot à épices	320-322, 512
pot à sauce acier inox	65-66
pot à sauce mélamine	65-66
pot en verre avec couvercle	138-139, 519-520
pot verseur universel	332, 465-466
poubelle à pédale	483
poubelle de table	145-148, 302-304
présentoir	40, 108, 347
présentoir à assiettes	114-116, 118-120, 282
présentoir à gâteaux	38, 45-48, 117, 183, 216, 256-257, 290-293
présentoir à sandwiches	127
présentoir buffet	15, 22-24, 35, 74-75, 104-107, 109-110, 112, 121, 126, 131, 199, 366,
présentoir buffet acier inox	107, 173, 200, 377
présentoir buffet bois	15, 21, 104, 106
présentoir buffet chromé	35, 105-107, 126, 173, 200
présentoir buffet de froid	17, 19, 25, 61, 69, 74-75
présentoir buffet en escalier	122-125
présentoir pour le buffet	32, 39, 69
presse citron	452, 518
R	
rack porte-verres	435
rack pour planches à découper	522
rafraîchisseur	460
rafraîchisseur de bouteilles	28, 426, 429-434, 437, 460
rafraîchisseur de caviar	42, 294
ramasse-miettes	147, 313, 477
ramequin	254-255
réchaud à beurre et sauce	294
réceptacle bain-marie	513
réceptacle de table	146-148

résistance	94, 397, 398-399
S	
saucière	295
seau à champagne	430-431
seau à glaçons	19, 84, 454
seau à glaçons isothermique	426, 453
seau à vin ou champagne	426-429, 431-432
service à parmesan	328
set apéritif	248, 323-329
set cloche à fromage	39, 59
set de table	347-350
set thermo	75
shaker	443-444
snackbox	268, 275
sonnette	483
soucoupes ardoise naturelle	51, 289, 319
soucoupes liège, bois	89-92, 526
spatule	413-415, 486, 489-491, 494, 506-507
spatule coudée spéciale grill	508
spatule pâtissière	506
stylo	312
sucrier	331-333, 465-467, 470
superbox	22-24
support	199, 329, 428, 522
support à bretzel ou à saucissons	59, 119
support à cornets	522
support multiple acier inox	135-136
support pour brochettes	294
T	
tamis	449, 451, 511-513
tapis antidérapant	166
tapis de bar	458
tapis égouttoir	458
tasse à café	259
tasse mélamine	259
théière ASIA	85, 467
tire-bouchons	464
tour de service	134
truelle de service	268, 471
V	
vase soliflor	346
verre mélangeur	461
verres à moutarde	325
verres gourmet	281
verseurs continus	462
vitrine de buffet	67-68, 70-73
W	
Weck-bouteilles	280-282



Buffet & Display



Tablets
Karaffen
Dispenser
Buffetständer
Isolierkannen

trays
carafes
dispensers
buffet stands
vacuum jugs

bandejas
jarras
dispensadores
soportes para buffet
jarras termo

plateaux
carafes
distributeurs
présentoires buffet
bouteilles isotherme

ELEMENT



Bekannt aus dem Bereich der Inneneinrichtung, lässt sich Beton nun auch im Buffetbereich stilvoll einsetzen. ELEMENT bietet drei unterschiedliche Präsentationsschalen, die sehr ansprechend in jede rustikale, natürliche aber auch urbane Buffetlandschaft integriert werden kann.

Known from the interior design sector, concrete can now also be used stylishly in the buffet area. ELEMENT offers three different presentation bowls, which can be very attractively integrated into any rustic, natural but also urban buffet landscape.

Conocido del sector de diseño interior, ahora el homigón también puede ser utilizado en el área del buffet. ELEMENT ofrece tres cuencos de presentación diferentes, que pueden ser integrados atractivamente en cualquier paisaje de buffet rústico, natural, pero también urbano.

Connu dans le domaine du design d'intérieur, le béton peut désormais être utilisé avec élégance dans la zone du buffet. ELEMENT offre trois bols de présentation différents, qui peuvent être intégré très attrayante dans n'importe quel paysage de buffet rustique, naturel, mais aussi urbain.





Schale „ELEMENT“

bowl
cuenco
bol



	Ø cm	↑ cm	ltr.	€
30000	22	6,0 / 10,5	1,1	18,50



Schale „ELEMENT“

bowl
cuenco
bol



	Ø cm	↑ cm	ltr.	€
30001	26	7,5 / 13,0	1,7	22,00



Schale „ELEMENT“

bowl
cuenco
bol



	Ø cm	↑ cm	ltr.	€
30002	29,5	8,5 / 14,5	2,5	25,00



Buffetständer

buffet stand
expositor de buffet
présentoir buffet



Akazienholz

acacia wood
madera de acacia
bois d'acacia

	Ø cm	↑ cm	€
33255	15	10	15,00



Buffetständer

buffet stand
expositor de buffet
présentoir buffet



Akazienholz

acacia wood
madera de acacia
bois d'acacia

	Ø cm	↑ cm	€
33256	25	15	18,00

COCONUT



Schale „COCONUT“

bowl
cuenco
bol



	Ø cm	↑ cm	ltr.	€
30020	18	9,5	1	20,00



Schale „COCONUT“

bowl
cuenco
bol



	Ø cm	↑ cm	ltr.	€
30021	23	12,5	2,2	25,00



FRAMES



Die reduzierte, archetypische Formsprache von FRAMES nimmt sich elegant zurück und lässt damit viel Raum für die Inszenierung der Buffet-Speisen. Ein scheinbarer Widerspruch löst sich auf: das Design ist zeitgemäß und zeitlos zugleich.

Design in detail – The classic minimalist visual style of FRAMES is elegantly understated, leaving plenty of potential for creating appealing buffet arrangements. Its design transcends what at first seems to be an irreconcilable paradox, being at once both timeless and highly contemporary.

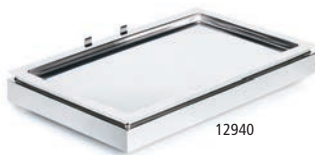

12940



14940



13940

Kühltablets SET 1 „FRAMES“

cooling plates
bandejas refrigeradas
plateaux réfrigérés



GN 1/1 Basiselement, GN 1/1 Edelstahl Tablett 18/10, Kühlakku
GN 1/1 base element, GN 1/1 stainless steel platter 18/10, cooler
elemento básico GN 1/1, bandeja GN 1/1 de acero inoxidable 18/10, acumulador de frío
élément de base GN 1/1, plateau GN 1/1 inox 18/10, accumulateur de froid

	cm	↑ cm	GN	Farbe / Colour		€
12940	53 x 32,5	8,5	1/1	stainless steel		224,00
14940	53 x 32,5	8,5	1/1	wenge wood		226,00
13940	53 x 32,5	8,5	1/1	ahorn wood		226,00



12941



14941



13941

Kühltablets SET 2 „FRAMES“

cooling plates
bandejas refrigeradas
plateaux réfrigérés



GN 1/1 Basiselement, GN 1/1 Edelstahl Tablett 18/10, Rolltop-Haube, Kühlakku
GN 1/1 base element, GN 1/1 stainless steel platter, rolltop cover, cooler
elemento básico GN 1/1, bandeja GN 1/1 de acero inoxidable 18/10, campana rolltop, acumulador de frío
élément de base GN 1/1, plateau GN 1/1 inox 18/10, cloche rolltop, accumulateur de froid

	cm	↑ cm	GN	Farbe / Colour		€
12941	53 x 32,5	27,5	1/1	stainless steel		286,00
14941	53 x 32,5	27,5	1/1	wenge wood		289,00
13941	53 x 32,5	27,5	1/1	ahorn wood		289,00



Schneidebrett „FRAMES“

chopping Board
tabla para cortar
planche à découper



Ahorn, massiv
ahorn wood, solid
madera de arce, masivo
bois d'érable, massif

	cm			€
13955	53 x 32,5	1/1		51,50
13960	53 x 32,5	1/1	gerillt	55,60



Schneidebrett „FRAMES“

chopping Board
tabla para cortar
planche à découper



	cm	GN		€
17910	53 x 32,5	1/1		54,00



GN Edelstahl Tablett „FRAMES“

GN stainless steel platter
GN bandeja acero inoxidable
GN plateau acier inox



	cm	GN		€
11119	53,0 x 32,5	1/1		28,00
11118	32,5 x 26,5	1/2		16,00



GN Tablett „FRAMES“

GN tray
GN bandeja
GN plateau



	cm	↑ cm	GN	€
84046	53,0 x 32,5	2	1/1	26,00
84047	32,5 x 26,5	2	1/2	14,20
84048	32,5 x 17,6	2	1/3	10,00



GN Tablett „FRAMES“

GN tray
GN bandeja
GN plateau



	cm	↑ cm	GN	€
82355	53,0 x 32,5	2	1/1	35,00
82356	32,5 x 26,5	2	1/2	20,00
82357	32,5 x 17,6	2	1/3	17,00



GN Polystyrolwanne „FRAMES“

GN polystyrene tray
GN bandeja poliestireno
GN plateau polystyrène



	cm	GN		€
17922	53 x 30	1/1		55,20



Korb „GN LINE“

GN basket
GN cesta
GN corbeille



stabile Ausführung mit Edelstahldraht im Rand zur Stabilisierung

very solid with stainless steel wire frame to stabilize the basket

muy resistente con refuerzo de alambre inox

très résistante avec son fil de renfort inox

	cm	↑ cm	GN	€
40291	53,0 x 32,5	6,5	1/1	18,50
40290	32,5 x 26,5	6,5	1/2	11,50
40293	53,0 x 32,5	10,0	1/1	23,00
40292	32,5 x 26,5	10,0	1/2	13,80



Buffetkorb

buffet basket
cesta de buffet
corbeille de buffet



Polyrattan, mit Haubenschiene (ohne Haube)

polyrattan, with frame to fix the (without cover)

polyrattan, con fijación para campana (sin campana)

polyrattan, avec fixation pour la cloche (sans cloche)

	Ø cm	↑ cm	€
40295	40	12,5	19,80



GN Basket

GN basket
cesta GN
corbeille GN



Polyrattan, mit Haubenschiene (ohne Haube)

polyrattan, with frame to fix the (without cover)

polyrattan, con fijación para campana (sin campana)

polyrattan, avec fixation pour la cloche (sans cloche)

	cm	↑ cm	€
40294	56,5 x 36,0	10,0	28,70



Rolltop-Haube

rolltop cover
campana abatible
cloche basculante



	Ø cm	↑ cm	€
18389	38	20	21,00



Eisbox „FRAMES“

ice box
bandeja para hielo para buffet
caisse à glaçons pour le buffet



3-teilig: 1 Basiselement Wenge + 1 Polystyrolwanne + 1 Tropfgitter

3 pcs. set: 1 box wenge + 1 plastic deep tray + 1 drainer plate

set de 3: 1 cajón color wengué, 1 cubeta plástico, 1 rejilla

set de 3: 1 caisson couleur wengé, 1 bac plastique, 1 plaque perforée

	cm	↑ cm	GN	Farbe / Colour	€
14970	53 x 32,5	12,5	1/1		179,00



GN 1/1 Rolltop-Haube
 GN 1/1 rolltop cover
 GN 1/1 campana abatible
 GN 1/1 cloche basculante



	cm	↑ cm	GN	€
11018	53 x 32,5	17	1/1	62,00



Besteck- / Universal-Box, 2-teilig „FRAMES“
 cutlery tray, 2 pcs.
 cubertero o cajón multi-usos, 2pz.
 caisson à couverts ou multi-usages



Buche massiv, Wenge, 4 Fächer, inklusive herausnehmbaren Einsatz
 wood wenge, 4 compartments
 madera de haya maciza, color wengué, 4 compartimentos, separadores removibles
 hêtre massif, couleur wengé, 4 compartiments, séparateurs amovibles

	cm	↑ cm	GN	Farbe / Colour	€
14956	53 x 32,5	11	1/1		174,00

Einsatz für GN 1/1 „FRAMES“ / insert for GN1/1 „FRAMES“ / interior para GN1/1 „FRAMES“ / insert pour GN1/1 „FRAMES“

	cm	↑ cm	Farbe / Colour	€
14954	48,5 x 28	8		40,00

14954
Einsatz



vielseitig einsetzbar für
alle GN 1/1 Artikel

Gestell für GN 1/1 „FRAMES“
 serving stand
 cubertero o cajón multi-usos
 caisson à couverts ou multi-usages



Buche massiv, Wenge
 wood, wenge
 madera de haya maciza, wengué
 hêtre massif, wengé

	cm	↑ cm	Farbe / Colour	€
14953	57,5 x 27,5	22		76,00



passendes Kühltablett Set



passende Besteck / Universal-Box
GN 1/1

NEW ACACIA



Buffetständer „ACACIA“

buffet stand
soporte para buffet
présentoir buffet



Akazienholz geölt / acacia wood oiled / madera de acacia aceitada / bois d'acacia huilé

	Ø cm	↑ cm	€
15620	20,0	10,5	22,00
15621	30,5	15,0	39,00
15622	30,5	20,0	42,00

Frischhalte- Haube / cover / campana / cloche



	Ø cm	↑ cm	fits to	€
06520	30	22	15621, 15622	29,90

Frischhalte- Haube / cover / campana / cloche



	Ø cm	↑ cm	fits to	€
06512	30	11,5	15621, 15622	6,20



Buffetständer „ACACIA“

buffet stand
soporte para buffet
présentoir buffet



Akazienholz geölt / acacia wood oiled / madera de acacia aceitada / bois d'acacia huilé

	cm	↑ cm	GN	€
15623	53 x 16,2	20	2/4	44,00

GN Abdeckhaube / GN cover / GN cubierta/ GN cloche



	cm	↑ cm	* mm	GN	€
11044	53 x 16,2	10,5	3	2/4	20,00

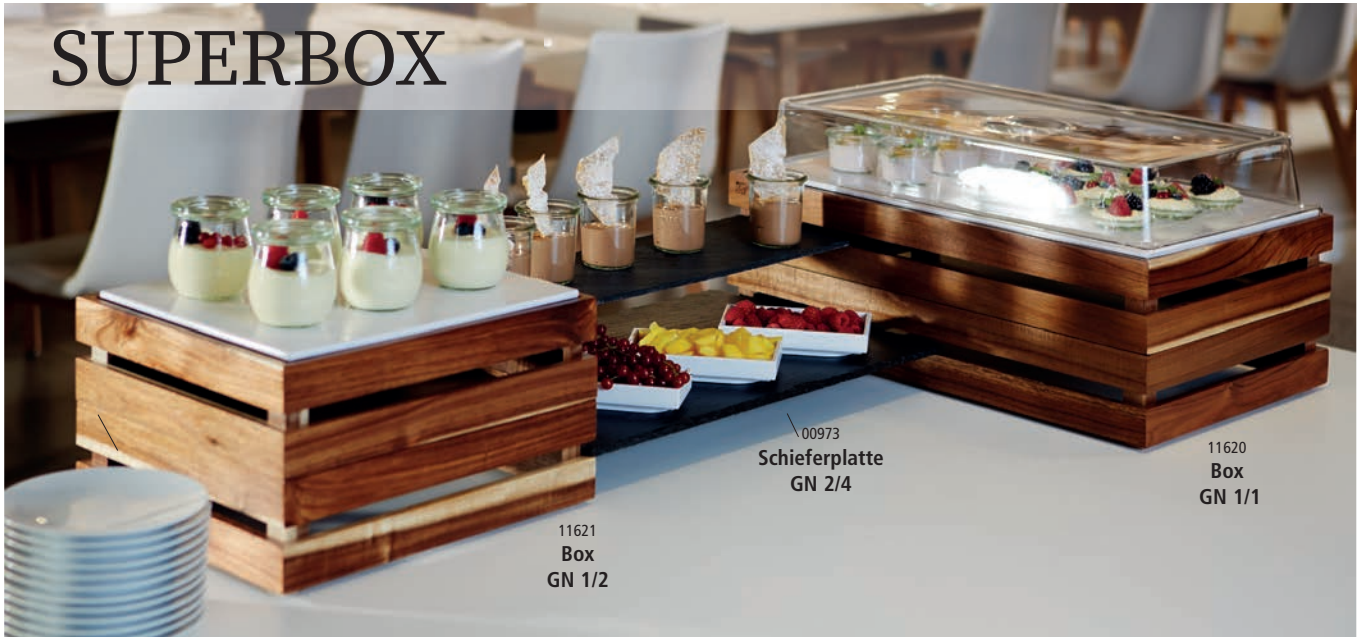

SUPERBOX

Die stapelbaren Wendeboxen lassen sich rutschfest stapeln und mit flachen GN Platten verbinden und einzeln nutzen. Individuell können Buffetlandschaften gebaut werden.

The stackable and non-slip reversible boxes can be connected to flat GN trays and can also be used individually. Different and individual buffet sceneries can be built up.

Las cajas girable y apilables son antideslizantes y se pueden conectar con bandejas planas GN o utilizar individualmente. Se pueden construir diferentes paisajes de buffet muy individuales.

Les boîtes de tournage empilables sont antiglissantes et peuvent être connectées avec des plateaux plats GN ou utilisées individuellement. Des paysages de buffet très personnalisés peuvent être construits.



11626

GN 1/1 „SUPERBOX“

Akazienholz / acacia wood / madera de acacia / bois d'acacia



	cm	↑ cm	Farbe / Colour	€
11620	55,5 x 35	10,5		33,00
11626	55,5 x 35	10,5		33,00



11623

11629

GN 2/4 „SUPERBOX“

Akazienholz / acacia wood / madera de acacia / bois d'acacia



	cm	↑ cm	Farbe / Colour	€
11623	55,5 x 18,5	10,5		27,00
11629	55,5 x 18,5	10,5		27,00



11627

GN 1/2 „SUPERBOX“

Akazienholz / acacia wood / madera de acacia / bois d'acacia



	cm	↑ cm	Farbe / Colour	€
11621	35 x 29	10,5		21,00
11627	35 x 29	10,5		21,00



11622

GN 1/4 „SUPERBOX“

Akazienholz / acacia wood / madera de acacia / bois d'acacia



	cm	↑ cm	Farbe / Colour	€
11622	29 x 18,5	10,5		16,80
11628	29 x 18,5	10,5		16,80



GN „SUPERBOX VINTAGE“



Akazienholz
 acacia wood
 mader de acacia
 bois d'acacia

	cm	↑ cm	GN	Farbe / Colour	€
11715	55,5 x 35,0	10,5	GN 1/1	■	39,00
11716	35,0 x 29,0	10,5	GN 1/2	■	24,00
11717	29,0 x 18,5	10,5	GN 1/4	■	19,00
11718	55,0 x 18,5	10,5	GN 2/4	■	29,00



Präsentationsmöglichkeit
 presentation example



GN Naturschieferplatten



GN natural slate tray
 GN bandeja de pizarra natural
 GN plat ardoise naturelle

	cm	GN	€
00990	53,0 x 32,5	1/1	15,00
00991	32,5 x 26,5	1/2	8,40
00993	26,5 x 16,2	1/4	4,60
00973	53,0 x 16,2	2/4	6,00



GN Einsatz „SUPERBOX“



GN insert
 GN bandeja
 GN bac supérieur

	cm	↑ cm	GN	fits to	€
11616	53,0 x 32,5	8,5	GN 1/1	11620, 11626, 11700, 11715	29,00
11617	32,5 x 26,5	8,5	GN 1/2	11621, 11627, 11701, 11716	24,00





GN „SUPERBOX VINTAGE“



Leichtes Holz, Tannenholz
fir wood
madera de abeto
bois sapin

	cm	↑ cm	GN	€
11700	55,5 x 35,0	10,5	GN 1/1	24,00
11701	35,0 x 29,0	10,5	GN 1/2	16,00
11702	29,0 x 18,5	10,5	GN 1/4	14,00
11703	55,0 x 18,5	10,5	GN 2/4	17,00



GN Tablett „ZERO“



GN tray
GN bandeja
GN plateau

	cm	↑ cm	GN	Farbe / Colour	€
84185	53,0 x 32,5	1,5	1/1	White	34,00
84195	53,0 x 32,5	1,5	1/1	Black	34,00
84186	32,5 x 26,5	1,5	1/2	White	18,20
84196	32,5 x 26,5	1,5	1/2	Black	18,20
84188	26,5 x 16,2	1,5	1/4	White	10,40
84198	26,5 x 16,2	1,5	1/4	Black	10,40
84189	53,0 x 16,2	1,5	2/4	White	20,00
84199	53,0 x 16,2	1,5	2/4	Black	20,00



mit Antirutschfüßchen
with non-slip feet



GN Naturschieferplatten



GN natural slate tray
GN bandeja de pizarra natural
GN plat ardoise naturelle

	cm	GN	€
00990	53,0 x 32,5	1/1	15,00
00991	32,5 x 26,5	1/2	8,40
00993	26,5 x 16,2	1/4	4,60
00973	53,0 x 16,2	2/4	6,00



BRIDGE



Mit hohem Anspruch an Design und Funktionalität haben wir das Buffet-System „Bridge“ für Sie entwickelt. Die in den Holzoberflächen Ahorn und Wenge erhältlichen Artikel sind in ihren Höhen und ihren Volumina optimal aufeinander abgestimmt und gewährleisten einen einfachen und sicheren Umgang in Ihrem Gastronomiealltag.

The collection "Bridge" is bringing perfectly coordinated components for an uncomplicated and organized buffet system, finalizing in an unique buffet scenery. All pieces combine perfectly with one another in their variations of sizes and volumes. The wooden items are available in 2 colors, maple or wenge. A simple and safe handling is guaranteed.

Una colección universal para un buffet único: un Sistema funcional y fácil de componer, asociado a la elegancia de su exclusive diseño. Los elementos se combinan a la perfección entre variaciones de Alturas y volúmenes, realizando sus propuestas y composiciones culinarias y modelando el paisaje del buffet. Las piezas están disponibles en 2 colores, wengué o arce. Manejo sencillo y seguro.

Une collection universelle pour une présentation unique de votre buffet: fonctionnel et facile à composer, ce système est à la fois pratique, simple et spectaculaire par son élégant design. Les différents éléments se marient à la perfection pour construire sans difficulté différentes compositions, variant les hauteurs et les volumes et mettant en valeur vos créations culinaires. Les pièces sont disponibles en deux couleurs, bois wengé ou érable.





Kühlbox „BRIDGE“
refrigerated buffet display
set de buffet refrigerado
présentoir buffet froid



Set bestehend aus: 1 Gestell aus Ahorn oder Wenge, 1 Behälter aus Kunststoff, 1 GN1/1 Tablett aus Melamin, 1 Kühlakku, 1 Rolltophaube (fix montiert)
set consists of: 1 base element maple or wenge, 1 plastic insert black, 1 GN1/1 tray melamine, 1 cooler, 1 cover (fixed)

set compuesto por: 1 soporte de madera arce o wengué, 1 cubeta de plástico, 1 bandeja de melamina GN 1/1, 1 acumulador de frío, 1 campana rolltop (fija)

set composé de: 1 support en bois érable ou wengé, 1 bac plastique, 1 plat en mélamine GN 1/1, 1 accumulateur de froid, 1 cloche rolltop (fixe)

	cm	↑ cm	Farbe / Colour		€
13990	63,5 x 42,5	31	 ahorn wood		334,00
14990	63,5 x 42,5	31	 wenge wood		334,00

**Kühlschale „BRIDGE“**

cooling bowl
bol refrigerado
bol réfrigéré



4-teilig: 1 Gestell aus Ahorn oder Wenge, 1 Behälter aus Edelstahl,
1 Schale aus Melamin (Ø 14 cm o. 23 cm), 1 Kühlakku

4 pcs.: 1 base element maple or wenge, 1 bowl stainless steel,
1 bowl melamine (Ø 14 o. 23 cm), 1 cooler

set de 4: 1 soporte de madera arce o wengué, 1 cuenco
de acero inoxidable, 1 cuenco de melamina (Ø 14 cm o 23 cm), 1 acumulador de frío

set de 4: 1 support en bois érable ou wengé, 1 bol en acier inox, 1 bol en mélamine
(Ø 14 cm ou 23 cm), 1 accumulateur de froid

	cm	↑ cm	ltr.	Farbe / Colour	€
13980	18,5 x 18,5	10	0,5		51,50
13981	27,5 x 27,5	14	2,5		102,00

	cm	↑ cm	ltr.	Farbe / Colour	€
14980	18,5 x 18,5	10	0,5		51,50
14981	27,5 x 27,5	14	2,5		102,00

**Edelstahlschale „BRIDGE“**

stainless steel bowl
cuenco acero inoxidable
bol acier inoxydable



	Ø cm	↑ cm		€
30050	14	8,5		23,00
30052	23	13,5		51,50

**Schale „CASUAL MAXI“**

bowl
cuenco
bol



	Ø cm	↑ cm	ltr.	Farbe / Colour	€
83700	14	6,5	0,5		4,00
83702	23	10,5	2,5		9,40
	Ø cm	↑ cm	ltr.	Farbe / Colour	€
83701	14	6,5	0,5		4,00
83703	23	10,5	2,5		9,40

**Frischhaltedeckel**

airtight cover
tapa hermética
couvercle hermétique



	Ø cm		€
10890	14		10,50
10887	23		19,00

Kühlakku / cooler / acumulador de frío / accumulateur de froid

	Ø cm	↑ cm	€
10661	10,5	2,5	3,20
10777	15,5	2,5	5,00



Cerealienspender „BRIDGE“

cereal dispenser
dispensador de cereales
distributeur de céréales



Behälter herausnehmbar, „Feierabend-Deckel“ für das aromadichte Lagern, portionieren durch einfaches Drehen

removable canister, special lid to keep the cereals fresh, easy to use, rotate the button to get the muesli

contenedor movible, tapa especial para mantener los cereales frescos, fácil de usar, se gira el pomo para servir los cereales

réceptier amovible, couvercle spécial pour conserver les céréales, usage facile en tournant le bouton

	cm	↑ cm	ltr.	Farbe / Colour	€
13987	21 x 20	55,5	4,5	Ahorn / maple	102,00

inkl. 3 Magnetschilder:
ORANGE, APPLE, GRAPEFRUIT



4 ltr.

Saftdispenser „BRIDGE“

juice dispenser
dispensador de zumo
distributeur à jus



Kühlung durch 2 Kühllakkus von oben und unten

cooling with 2 cooling elements from the top and base

2 acum. de frío 1 en la base y 1 en la tapa

2 plaques de froid 1 dans le couvercle, 1 dans le socle

	cm	↑ cm	ltr.	Farbe / Colour	€
10870	31,0 x 20	42	4	Ahorn / maple	224,00
10871	35,5 x 22	50	6	Ahorn / maple	264,00



Besteckbehälter „BRIDGE“

cutlery organizer
cajón para cubiertos
bac à couverts



2-teiliges Set: 1 Gestell, 1 Besteckbehälter (Nr. 11955), herausnehmbar

2 pcs set: 1 base element, 1 removable plastic container (item 11955)

set de 2 piezas: 1 soporte + 1 cubeta extraíble 4 compartimentos de plástico (ref. 11955)

set de 2 pcs: 1 support + 1 bac plastique amovible à 4 compartiments (réf. 11955)



	cm	↑ cm	Farbe / Colour	€
13995	57,5 x 37	12	Ahorn / maple	78,00

Konferenzkühler „BRIDGE“

bottle cooler
enfriador
refraîchisseur



2-teiliges Set, bestehend aus: 1 Gestell, 1 Behälter aus Edelstahl (doppelwandig)

2 pcs set: 1 base element, 1 bowl stainless steel (double-wall)

set de 2 piezas: 1 soporte, champanera inox de doble pared

set de 2 pcs: 1 support, seau inox double paroi



	cm	↑ cm	Farbe / Colour	€
13985	35 x 35	19	Ahorn / maple	154,00

**Cerealienspender „BRIDGE“**

cereal dispenser
dispensador de cereales
distributeur de céréales



Behälter herausnehmbar, „Feierabend-Deckel“ für das aromadichte Lagern,
portionieren durch einfaches Drehen

removable canister, special lid to keep the cereals fresh,
easy to use, rotate the button to get the muesli

contenedor movable, tapa especial para mantener los cereales frescos,
fácil de usar, se gira el pomo para servir los cereales

réceptif amovible, couvercle spécial pour conserver les céréales,
usage facile en tournant le bouton

	cm	↑ cm	ltr.	Farbe / Colour		€
14987	21 x 20	55,5	4,5	■	Wenge / wenge	102,00

inkl. 3 Magnetschilder:
ORANGE, APPLE, GRAPEFRUIT



6 ltr.

10873

Saftdispenser „BRIDGE“

juice dispenser
dispensador de zumo
distributeur à jus



Kühlung durch 2 Kühllakkus von oben und unten

cooling with 2 cooling elements from the top and base

2 acum. de frío 1 en la base y 1 en la tapa

2 plaques de froid 1 dans le couvercle, 1 dans le socle

	cm	↑ cm	ltr.	Farbe / Colour		€
10872	31,0 x 20	42	4	■	Wenge / wenge	224,00
10873	35,5 x 22	50	6	■	Wenge / wenge	264,00

**Besteckbehälter „BRIDGE“**

cutlery organizer
cajón para cubiertos
bac à couverts



2 teiliges Set: 1 Gestell, 1 Besteckbehälter (Nr. 11955), herausnehmbar

2 pcs set: 1 base element, 1 removable plastic container (item 11955)

set de 2: 1 soporte, 1 cajón para cubiertos (ref. 11955), extraíble

set de 2: 1 support, 1 bac à couverts (réf. 11955), amovible

	cm	↑ cm	Farbe / Colour		€
14995	57,7 x 37	12	■	Wenge / wenge	78,00

**Flaschenkühler „BRIDGE“**

bottle cooler
enfriador
refraîchisseur



2-teiliges Set, bestehend aus: 1 Gestell, 1 Behälter aus Edelstahl (doppelwandig)

2 pcs set: 1 base element, 1 bowl stainless steel (double-wall)

set de 2: 1 soporte, 1 cuenco de acero inoxidable (doble pared)

set de 2: 1 support, 1 bol en acier inox (double paroid)

	cm	↑ cm	Farbe / Colour		€
14985	35 x 35	19	■	Wenge / wenge	154,00

PROFI LINE



GN Edelstahl-Tablett „PROFI LINE“

GN tray

GN bandeja

GN plat empilable système catering



	cm	↑ cm	GN		€
11100	53,0 x 32,5	1,5	1/1	mit glattem Rand / without decor-edge sin borde decorado / bords lisses	27,00
12100	32,5 x 26,5	1,5	1/2	mit glattem Rand / without decor-edge sin borde decorado / bords lisses	16,00
11000	53,0 x 32,5	1,5	1/1	mit Dekor-Rand / with decor-edge con borde decorado / bords avec relief	27,00
12000	32,5 x 26,5	1,5	1/2	mit Dekor-Rand / with decor-edge con borde decorado / bords avec relief	17,50
11110	53,0 x 32,5	1,0	1/1	glatter schmaler Rand / smooth narrow edge / borde estrecho liso / bord étroit lisse	16,00

Fleisch- und Gemüseplatte „PROFI LINE“

tray

fuente de servicio

plat de service

Dekorrand hochglanzpoliert

decor edge mirror polished finish

borde decorado pulido efecto espejo

contour relief avec effet miroir



	Ø cm	↑ cm		€
11032	32	2,6		18,20
11038	38	2,6		27,20
11048	48	2,6		34,60

Fleisch- und Gemüseplatte „PROFI LINE“

tray

fuente de servicio

plat de service

Dekorrand hochglanzpoliert

decor edge mirror polished finish

borde decorado pulido efecto espejo

contour relief avec effet miroir



	cm	↑ cm		€
11023	50 x 36	2,6		34,60
11024	60 x 41	2,6		47,20
11025	70 x 46	2,6		65,40



11065

GN Edelstahl-Behälter „PROFI LINE“

GN pan
GN cubeta
GN bac



	cm	↑ cm	GN	litr.	€
11020	53,0 x 32,5	2,0	1/1	1,7	30,90
11040	53,0 x 32,5	4,0	1/1	3,4	33,80
11065	53,0 x 32,5	6,5	1/1	7,0	37,40
12040	32,5 x 26,5	4,0	1/2	2,0	20,40
12065	32,5 x 26,5	6,5	1/2	3,3	23,30

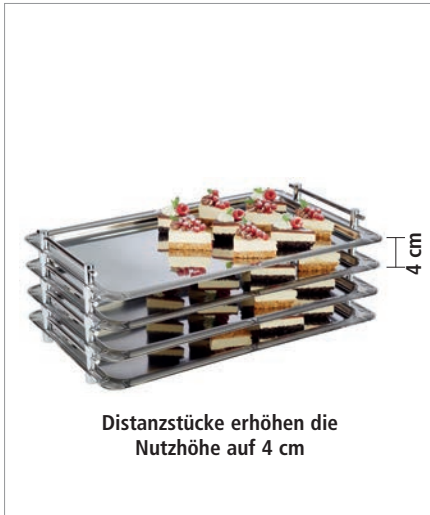

Distanzstücke erhöhen die Nutzhöhe auf 4 cm

GN 1/1 System-Tablett „PROFI LINE“

GN 1/1 tray
GN 1/1 bandeja
GN 1/1 plateau



Dekorrand hochglanzpoliert, massive Griffe verchromt, inkl. fest verschraubten Distanzstücken, Nutzhöhe 4 cm

decor edge mirror polished finish, chrome plated handles, incl. mounted 4 cm distance pillars

borde decorado pulido brillante, asas cromadas, incl. distanciadores atornillados, con profundidad efectiva de 4 cm

bord avec reliefs poli miroir, poignées chromées, incl. distance bien fixée avec hauteur utile de 4 cm

	cm	GN	€
11300	53 x 32,5	1/1	39,50



Distanzstücke erhöhen die Nutzhöhe auf 4 cm

GN 1/1 System-Tablett „PROFI LINE“

GN 1/1 tray
GN 1/1 bandeja
GN 1/1 plateau



Rand hochglanzpoliert, massive Bügelgriffe vergoldet, inkl. fest verschraubten Distanzstücken, Nutzhöhe 4 cm

mirror polished finish edge, gold plated handles, stackable approx. 4 cm

borde pulido brillante, asas doradas, incl. distanciadores atornillados, con profundidad efectiva de 4 cm

bord poli miroir, poignées dorées, incl. distance bien fixée avec hauteur utile de 4 cm

	cm	GN	€
11290	53 x 32,5	1/1	33,00



11150
mit verchromten Griffen

11155
mit vergoldeten Griffen

GN 1/1 System-Tablett „BUFFET-STAR“

GN 1/1 tray
GN 1/1 bandeja
GN 1/1 plateau



Rand hochglanzpoliert, inkl. fest verschraubten Griffen inkl. Distanzstücken, Nutzhöhe 4 cm

mirror polished finish edge, incl. screwed handles incl. distance pillars, 4 cm distance

borde pulido brillante, incl. asas atornillables, incl. distanciadores con profundidad efectiva de 4 cm

bord poli miroir, incl. poignées à visser, incl. distance avec hauteur utile de 4 cm

	cm	GN		€
11150	53 x 32,5	1/1	mit verchromten Griffen / with chrome plated handles / con asas cromadas / avec poignées chromées	33,00
11155	53 x 32,5	1/1	mit vergoldeten Griffen / with gold plated handles / con asas doradas / avec poignées dorées	36,00



System-Tablett „BUFFET-STAR“

system tray
bandeja del sistema
plat empilable système catering



Rand hochglanzpoliert, inkl. fest verschraubten Griffen inkl. Distanzstücken, Nutzhöhe 4 cm
mirror polished finish edge, incl. screwed handles incl. distance pillars, 4 cm distance
borde pulido efecto espejo, incluye asas atornillables, distanciadores a 4 cm
contour effet miroir, poignées à visser, distance approx. 4 cm

	Ø cm		€
11160	48	mit verchromten Griffen / with chrome handles	46,00
11165	48	mit vergoldeten Griffen / gold plated handles	49,00

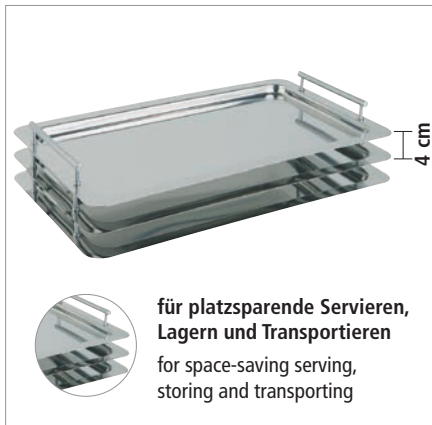

GN 1/1 System-Tablett „CLASSIC“

GN tray
GN bandeja
GN plat empilable système catering



Rand hochglanzpoliert, mit fest verschraubten Griffen inkl. Distanzstücken, Nutzhöhe 4 cm
mirror polished finish edge, incl. screwed handles incl. distance pillars, 4 cm distance
borde pulido efecto espejo, incluye asas atornillables, distanciadores a 4 cm
contour effet miroir, poignées à visser, distance approx. 4 cm

	cm	GN	€
11295	53 x 32,5	1/1	34,00



Tablett „SWING“

tray
bandeja
plateau



Rand matt poliert, innen hochglanzpoliert
satin polished finish edge, inside mirror polished finish
borde pulido efecto satinado, interior pulido efecto espejo
contour effet mat, intérieur poli miroir

	cm	↑ cm	GN	€
01415	28,5 x 20,0	1		18,00
01416	32,5 x 32,5	1		24,00
01420	53,0 x 32,5	1	1/1	39,00



Tablett „SUNDAY“

tray
bandeja
plateau



hochglanzpoliert
mirror polished finish
acabado espejo pulido
effet brillant

	cm	↑ cm	GN	€
11210	32,5 x 26,5	2	1/2	22,00
11220	53,0 x 32,5	2	1/1	38,00



11195
2-tlg. Set Tablett + Haube

stapel- und
fixierbar

GN 1/1 Buffet-Set „CATERER“

GN 1/1 buffet set
GN 1/1 set de bufé
GN 1/1 set catering: plateau + cloche



2-teilig: Tablett + Haube, Tablett fixiert sich auf der Haube - kein Rutschen möglich
2 pcs. set: tray + cover, tray fixes itself on the cover and can not slip off
set de 2: bandeja + tapa, la bandeja encaja encima de la tapa para que no se deslice
set de 2: plateau GN 1/1 réf. + cloche spéciale empilement stable

	cm	↑ cm	GN	€
11195	53 x 32,5	10,5	1/1	63,70



11302
GN 1/1, 2-tlg. Set Tablett + Haube

GN 1/1 Buffet-Set „HOCHSTAPLER“

GN 1/1 buffet set
GN 1/1 set de bufé
GN 1/1 kit catering plateau + cloche



2-teilig: Tablett + Haube, Tablett fixiert sich auf der Haube - kein Rutschen möglich
2 pcs. set: tray + cover, tray fixes itself on the cover and can not slip off
set de 2: bandeja + tapa, la bandeja encaja encima de la tapa para que no se deslice
set de 2: plateau GN 1/1 réf. + cloche spéciale empilement stable

	cm	↑ cm	GN	€
11302	53 x 32,5	10,5	1/1	68,00



11305
Haube / cover

11300
Tablett / tray
Haube für stapelbare Tablett:
11300, 11290 oder 11295

GN 1/1 Haube „HOCHSTAPLER“

GN 1/1 cover
GN 1/1 campana
GN 1/1 cloche



glasklarer Kunststoff, Tablett fixiert sich auf der Haube - kein Rutschen möglich, nahezu bruchfest

clear plastic, tray fixes itself on the cover and can not slip off, nearly unbreakable

plástico transparente, la bandeja se fija a la tapa para que no se deslice, muy resistente a la rotura

en plastique transparent, le plat se fixe sur le dessous de la cloche pour ne pas glisser, très résistant à la casse

	cm	↑ cm	fits to	GN	€
11305	53 x 32,5	9	11300, 11290, 11295	1/1	30,00



GN Abdeckhaube

GN cover
GN cubierta
GN cloche



	cm	↑ cm	✱ mm	GN	€
11041	32,5 x 26,5	9,5	3	1/2	20,00
11042	53,0 x 32,5	9,5	3	1/1	28,00
11043	32,5 x 17,6	10,5	3	1/3	15,00
11044	53,0 x 16,2	10,5	3	2/4	20,00



Tablett „SCHÖNER ESSEN“

tray
bandeja
plateau

cm		€
00383	35,0 x 24,0	6,80
00382	42,0 x 31,0	9,80
00381	50,0 x 36,0	14,00
00384	63,5 x 44,5	27,00
00385	60,0 x 40,0	25,00
cm		€
03824	42,0 x 31,0	leichte Ausführung 0,5 mm / extra light model 0,5 mm modelo extraligero 0,5 mm / qualité légère, ép. 0,5 mm 8,80
03814	50,0 x 36,0	leichte Ausführung 0,5 mm / extra light model 0,5 mm modelo extraligero 0,5 mm / qualité légère, ép. 0,5 mm 10,00



GN 1/1 Tablett „SCHÖNER ESSEN“

GN tray
GN bandeja
GN plateau

cm	GN	€
00388	53,0 x 32,5 / 1/1	15,40



Tablett „SCHÖNER ESSEN“

tray
bandeja
plateau

mit Dekorrand, Griffe Zinkdruckguss verchromt, genietet
with decor edge, handles zinc alloy chrome plated, riveted
borde decorado, asas fundición con zinc
bord décor, poignées en fonte zinguée

cm		€
00082	52 x 31,0	15,00
00081	60 x 36,0	20,80
00084	75 x 44,5	35,00



Tablett „SCHÖNER ESSEN“

tray
bandeja
plateau

cm		€
00087	38 x 23	rechteckig, abgerundet / rectangular, rounded edge rectangular / rectangulaire 8,00

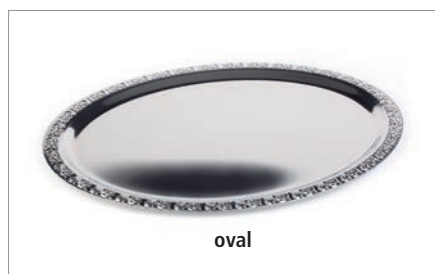

Tablett „SCHÖNER ESSEN“

tray
bandeja
plateau

cm		€
00089	50 x 39,5	15,00



Tablett „SCHÖNER ESSEN“

tray
bandeja
plateau



	Ø cm	€
00075	31	6,30
00085	35	8,60



Tablett mit Haube „SCHÖNER ESSEN“

tray with cover
bandeja con cubierta
plateau avec cloche



	cm	↑ cm	€
38202	42 x 31	8	14,00

Haube / cover / campana / cloche

	cm	↑ cm	€
08201	36,5 x 26,0	7,5	3,90



GN 1/1 Tablett „STAR“

GN tray
GN bandeja
GN plateau



Rand hochglanzpoliert mit Prägung

polished decor edge

borde pulido decorado

bords polis miroir, avec relief sur les petits côtés

	cm	GN	€
11115	53 x 32,5	1/1	27,50



griffig, keine Fingerabdrücke sichtbar, Randprägung auf kurzen Seiten
catchy, fingerprints are not visible, edge lettering on the short sides



GN 1/1 Buffet-Tablett „HALBMOND“

GN tray
GN bandeja
GN plat demi-lune



mit klassischem Linienpräggedekor, passend für Thermoboxen GN 1/1 und Thermoporte

with decor edge, usable in thermoboxes GN 1/1

con borde decorado, apto para cajas térmicas GN 1/1

bords avec relief, apte pour conteneurs GN 1/1

	cm	GN	€
11111	53 x 32,5	1/1	18,00



Edelstahl-Schale

bowl
bandeja ovalada inox
corbeille ovale inox



eingerollter Rand

rolled edge

borde redondeado

bord roulé

	cm	↑ cm	€
40110	26,5 x 18,5	4,0	7,80
40115	31,0 x 21,0	4,5	11,00

**Tablett**

tray
bandeja
plateau

mit gebördeltem, polierten Rand
rolled and mirror polished edge
borde redondeado acabado efecto espejo
bord rond, effet miroir



	Ø cm	↑ cm		€
01336	35	3		26,00

**Buffetständer**

buffet stand
soporte buffet
support buffet



	Ø cm	↑ cm	fits to	€
74207	20 - 25	19	01336	11,00



Ø 19 cm - Ø 28 cm - Ø 40 cm

Servierpfanne

pan
fuente para la mesa
plat pour la table
mit vergoldeten Edelstahl-Griffen, 1 mm dick
with gold plated handles, 1 mm thickness
grosor 1 mm., asas doradas
épaisseur 1 mm, poignées dorées



	cm	↑ cm	ltr.	€
61190	19	3,5	0,7	15,00
61280	28	4,0	2,0	22,00
61400	40	5,0	4,5	56,00



60270

60310

Servierpfanne

pan
fuente para la mesa
plat pour la table
mit vergoldeten Edelstahl-Griffen, 1 mm dick
with gold plated handles, 1 mm thickness
grosor 1 mm., asas doradas
épaisseur 1 mm, poignées dorées



	cm	↑ cm	ltr.	€
60270	26,5 x 19,5	3	0,8	17,00
60310	31,0 x 21,5	3	1,2	21,00



01311

Tablett „FINESSE“

tray
bandeja
plateau



	cm	€
01314	30 x 24	7,80
01313	35 x 24	9,00
01317	39 x 26	10,20
01312	42 x 31	11,50
01318	48 x 30	11,00
01311	50 x 38	16,00
01310	58 x 42	27,00
01309	68 x 48	38,00



01338

Tablett „FINESSE“

tray
bandeja
plateau



	Ø cm	€
01332	32,0	8,60
01335	35,0	10,20
01338	38,0	11,50
01348	48,0	21,40
01349	48,5	22,80
01358	58,0	49,00



01324

oval

Tablett „FINESSE“

tray
bandeja
plateau



	cm	€
01322	42 x 30	13,80
01323	50 x 36	20,00
01324	60 x 41	28,00
01325	70 x 46	40,50



01738

Tablett „FINESSE“

tray
bandeja
plateau



verchromte Messing-Griffe
chrome plated brass handles
asas plateadas de latón
poignées en laiton chromées

	Ø cm	€
01738	38	21,10
01748	48	34,60

**Tablett „FINESSE“**

tray
bandeja
plateau

verchromte Messing-Griffe
chrome plated brass handles
asas de latón cromadas
poignées en laiton chromées



	cm	€
01712	44 x 31	20,40
01711	52 x 38	26,50
01710	60 x 42	39,00
01709	70 x 48	51,50

**Tablett mit Haube „FINESSE“**

tray with cover
bandeja con campana
plateau avec cloche



	cm	↑ cm	€
13122	42 x 31	8,5	18,40

**Tablett mit Haube „FINESSE“**

tray with cover
bandeja con campana
plateau avec cloche



	Ø cm	↑ cm	€
13622	22	9,5	6,20

**Tablett mit Haube „FINESSE“**

tray with cover
bandeja con cubierta
plateau avec cloche



	Ø cm	↑ cm	Ø cm Hauben / cover	€
13382	38	12	30	19,00
13385	38	13	33	20,50

**Edelstahltablett**

tray
bandeja
plateau



	cm	↑ cm	€
09010	43,5 x 32,5	1,5	19,00

Rolltophaube „PURE“ / rolltop cover / campana abatible / cloche basculante

	cm	↑ cm	€
09013	44 x 33,5	17	24,00



Tablett „ELEGANCE“

tray
bandeja
plateau



	cm	€
02310	41 x 26	12,60
02311	48 x 30	16,00
02312	60 x 37	24,00



Tablett mit Haube „ELEGANCE“

tray with cover
bandeja con cubierta
plateau avec cloche



	cm	↑ cm	€
23642	35 x 19	10	9,00



Serviertablett mit Haube

tray
bandeja
plateau



	cm	↑ cm	€
00064	33 x 17	10	5,90
00067	25 x 19	7	6,40

Haube für 00064 / cover for 00064 / campana para 00064 / cloche pour 00064

06401	€	3,00
-------	---	------

Haube für 00067 / cover for 00067 / campana para 00067 / cloche pour 00067

06701	€	2,00
-------	---	------



Tortenplatte mit Haube

cake plate with cover
bandeja tarta con campana
plat à tarte avec cloche



	Ø cm	↑ cm		€
00065	30	11	mit 1 Haube / with 1 cover	6,40
00652	30	7 + 11	mit 2 Hauben / with 2 cover	7,90



Tortenplatte „BAROCK“

cake plate
bandeja tartas
plat à gâteau



2-teilig: Tortenplatte mit Barock-Rand + Haube (extra stabil)

2 pcs. set: cake plate with decor edge „Barok“ + cover (extra robust)

set de 2: porta tartas, borde decor „Barok“ + campana (extra fuerte)

set de 2: plateau bord décor „Barok“ + cloche ultra-résistante

	Ø cm	↑ cm	€
06503	32	10	10,00

Frischhalte-Haube / cover / campana / cloche

	Ø cm	↑ cm	€
06510	30	11,5	4,40



Käseglocken-Set „BRAZIL“

rolltop set
set rolltop
set cloche á fromage



3-teilig: Tablett + Holzschneidebrett + Rolltophaube glasklar, rutschfeste Haubenfixierung

3 pcs. set: tray + wooden board + rolltop cover, cover non-slip fixed

set de 3: bandeja + tablero de madera + campana abatible, fijación antideslizante

set de 3: plateau + planche à découper + cloche abattante, fixation antiglisse

	Ø cm	↑ cm	€
09085	45	24	72,00



Rolltop-Set

rolltop set
set rolltop
set cloche à fromage



2-teilig: Tablett + Rolltophaube glasklar, rutschfeste Haubenfixierung, klappbar

2 pcs. set: tray + rolltop cover, cover non-slip fixed, mountable

set de 2: bandeja + campana abatible fijación antideslizante, montable

set de 2: plateau + cloche abattante, fixation antiglisse, montable

	Ø cm	↑ cm	€
09080	38	24	34,00
09099	50	28	75,00



Rolltop-Set

rolltop set
set rolltop
set rolltop



2-teilig: Schneidbrett marmoriert + Rolltophaube glasklar, rutschfeste Haubenfixierung, klappbar

2 pcs. set: plastic board + rolltop cover, cover non-slip fixed, mountable

set de 2: tablero de plástico + tapa abatible, tapa antideslizante, montable

set de 2: planche à découper + cloche abattante, fixation antiglisse, montable

	Ø cm	↑ cm	€
09081	38	24	46,00



Rolltop-Set, 3-teilig

rolltop set, 3 pcs.
rolltop, set de 3
rolltop, set de 3



1 Edelstahltablett Ø 38 cm + 1 Naturschieferplatte Ø 33 cm + 1 Rolltophaube Ø 38 cm

1 stainless tray Ø 38 cm + 1 natural slate tray Ø 33 cm + 1 rolltop cover Ø 38 cm

1 bandeja de acero inoxidable Ø 38 cm + 1 bandeja de pizarra natural Ø 33 cm + 1 tapa abatible Ø 38 cm

1 plat inox 38 cm + 1 plat ardoise naturelle 33 cm + 1 cloche 38 cm

	Ø cm	↑ cm	€
01000	38	24	44,00



Buffet-Set, 2-teilig

buffet set, 2 pcs.
set de bufé, set de 2
présentoir pour le buffet, set de 2



1 Platte + 1 Rolltophaube, schnidfeste und porenfreie Oberfläche, rutschfeste Haubenfixierung, Platte mit rutschfesten Füßen

2 pcs. set: glass board + rolltop cover, scratch-resistant surface, cover non-slip fixed, non-slip feet

set de 2: bandeja vidrio redonda + campana abatible, fijación antideslizante, pies antideslizantes

set de 2: plateau verre rond + cloche abattante, fixation antiglisse et pieds antidérapants

	Ø cm	↑ cm	€
00978	38	23	34,00

PARTYPLATTEN

Nicht säure- und spülmaschinenfest, Lebensmittel nur mit Papierdeckchenunterlage servieren.

Non-acid and dishwasher-proof, serve food only with paper tray covers.

No resistente a los ácidos y al lavavajillas, servir alimentos sólo con papel para bandeja party.

Pas résistant aux acides et au lave-vaisselle, servent la nourriture seulement avec papier dentelles.



00393 oder / or 00396
96 x

00391 oder / or 00398
96 x

00392 oder / or 00399
96 x

00394 oder / or 00395
96 x

Warenträger

display
expositor
présentoir

für Partyplatten

- platzsparende flexible Präsentation durch geringe Abmessungen
- als Zweitplatzierung für Ihre zusätzlichen Umsätze
- in weiß lieferbar

for partytrays- space saving presentation- small size- available in white
para bandejas Party, ocupa poco espacio, disponible en blanco
pour plateaux Party, occupe très peu d'espace, disponible en blanc

	cm	↑ cm
00397	55 x 65	190



Partyplatte „CLASSIC“

partytray
bandeja party
plateau party



mit Liniendekor, Rand eingerollt
with line decor, rolled edge
con filos en relieve
avec décoration lignée, bord rond

	Ø cm	VE / unit	€/ pc.
00396	35	48	3,20



Partyplatte „CLASSIC“

partytray
bandeja party
plateau party



mit Liniendekor, Rand eingerollt
with line decor, rolled edge
con filos en relieve
avec décoration lignée, bord rond

	cm	VE / unit	€/ pc.
00398	46 x 34	48	3,20



Partyplatte „CLASSIC“

partytray
bandeja party
plateau party



mit Liniendekor, Rand eingerollt
with line decor, rolled edge
con filos en relieve
avec décoration lignée, bord rond

	cm	VE / unit	GN	€/ pc.
00395	53,0 x 32,5	36	1/1	5,20
00399	41,0 x 31,0	48		3,20
00389	35,4 x 32,5	48	2/3	3,00

hot
price**Partyplatte**partytray
bandeja party
plateau party**Innenfläche ziseliert, Rand eingerollt**

rolled edge, decorated surface

borde redondeado, superficie totalmente decorada

bord rond, surface entièrement ciselée

	Ø cm	VE / unit	€ / pc.
00393	35	48	3,20

hot
price

oval

Partyplattepartytray
bandeja party
plateau party**Innenfläche ziseliert, Rand eingerollt**

rolled edge, decorated surface

borde redondeado, superficie totalmente decorada

bord rond, surface entièrement ciselée

	cm	VE / unit	€ / pc.
00391	46 x 34	48	3,20

hot
price**Partyplatte**partytray
bandeja party
plateau party**Innenfläche ziseliert, Rand eingerollt**

rolled edge, decorated surface

borde redondeado, superficie totalmente decorada

bord rond, surface entièrement ciselée

	cm	VE / unit	€ / pc.
00392	41 x 31	48	3,20

hot
price

GN 1/1

GN 1/1 PartyplatteGN partytray
GN bandeja party
GN plateau party**Innenfläche ziseliert, Rand eingerollt**

rolled edge, decorated surface

borde redondeado, superficie totalmente decorada

bord rond, surface entièrement ciselée

	cm	VE / unit	GN	€ / pc.
00394	53 x 32,5	36	1/1	5,20



Serviertöpfchen

small serving pot
olla pequeña de servir
marmite petite de servir



gehämmerte Oberfläche
hammered surface
superficie martillada
surface martelée

	Ø cm	↑ cm	ltr.	Griff	€
40186	9,5	5,5	0,30	2,5	7,40
40187	13,5	5,0	0,55	3,0	8,40
40188	15,5	5,0	0,75	3,0	10,00



Kaviarkühler

caviar cooler
enfriador de caviar
rafraîchisseur de caviar



4-teilig: 1 Edelstahlschale, 1 Halter, 1 Glashalm, 1 Edelstahldeckel

4 pcs.: 1 stainless steel bowl, 1 holder, 1 glass bowl Ø 10 cm, 1 stainless steel cover

set de 4: 1 bol de acero inoxidable, 1 soporte, 1 bol de vidrio Ø 10 cm, 1 tapa de acero inoxidable

set de 4: 1 bol en acier inox, 1 support, 1 bol en verre Ø 10 cm, couvercle en acierinox

	Ø cm	↑ cm	€
01699	18	12	49,90



matt poliert
satin polished finish

30112

Serviertablett „KAFFEEHAUS“

tray
bandeja
plateau



matt poliert, oval, Rand eingerollt

satin polished finish, oval, rolled edge

pulido acabado efecto satinado, oval, borde redondeado

effet satin, ovale, bord rond

	cm	↑ cm		€
30111	19,0 x 15,0	1	für Zucker und Sahne / for sugar and cream	4,30
30112	26,5 x 19,0	1	für eine Tasse / for one cup	6,50
30113	29,0 x 22,0	1	für zwei Tassen / for two cups	6,90
30123	23,0 x 17,5	1	für zwei Tassen / for two cups	6,10



hochglanzpoliert
mirror polished finish

30116

Serviertablett „KAFFEEHAUS“

tray
bandeja
plateau



hochglanzpoliert, oval, Rand eingerollt

mirror polished finish, oval, rolled edge

pulido efecto espejo, ovalado, borde redondeado

effet brillant, ovale, bord rond

	cm	↑ cm		€
30115	19,0 x 15	1	für Zucker und Sahne / for sugar and cream para azúcar y crema / pour le sucre et la crème	4,30
30116	26,5 x 19	1	für eine Tasse / for one cup para una taza / pour une tasse	6,50
30117	29,0 x 22	1	für zwei Tassen / for two cups para dos tazas / pour deux tasses	6,90



Serviertablett „KAFFEEHAUS“

tray
bandeja
plateau

matt poliert, Rand eingerollt
satin polished finish, rolled edge
acabado pulido satinado, borde redondeado
effet satin mat, bord rond



	cm	↑ cm	€
30118	21,5 x 13	1,5	7,20
30119	23,0 x 23	1,5	10,50
30120	20,0 x 11	1,5	6,80
30121	29,0 x 20	1,5	14,00



mattiert
satin polished finish

Serviertablett „KAFFEEHAUS“

tray
bandeja
plateau

	cm	↑ cm	€
30126	25,5 x 19,5	2	6,30

mattiert / satin polished finish
acabado efecto satinado / fini mat effet satin



84253

Serviertablett „KAFFEEHAUS“

tray
bandeja
plateau

	cm	↑ cm	Farbe / Colour	€
84251	26,0 x 20,0	1,5	■	4,20
84253	28,5 x 21,5	1,5	■	4,80



hot price

Serviertablett „KAFFEEHAUS“

tray
bandeja
plateau

Innenfläche ziseliert, Rand eingerollt
rolled edge
borde redondeado, superficie decor relieve
bord rond, surface entièrement ciselée



	cm	pcs.	€
30114	30 x 22	48	2,80

NEW



30130



30131



30132



30132



30133



30133



Tablett „VINTAGE“

tray
bandeja
plateau



Edelstahl-Look vintage
stainless steel vintage look
acero inoxidable look vintage
acier inox look vintage

	cm	↑ cm	€
30130	26,0 x 13,5	1,5	7,00
30131	34,0 x 18,0	1,5	12,00
30132	38,0 x 26,5	1,5	19,00
30133	25,5 x 16,0	3,0	14,00

passende Schälchen / fitting bowls / cuencos adecuados / bols apropiés



	Ø cm	↑ cm	litr.	€
40655	7,5	5,5	0,17	2,60
40656	7,5	10,0	0,35	3,20



S. 276
page 276

40656

40655



30130



30132

Servierbeispiel
presentation example

Tablett „TREND“

baking sheet
bandeja
plateau



ein Backblech wird zum Serviertablett
a baking sheet which becomes a serving tray
una bandeja de hornear que se convierte en una bandeja de servir
un moule qui devient un plateau de service

	cm	↑ cm	€
13380	32 x 21,5	2	9,00



Servier- und Tortenplatte „ACACIA MINI“

cake stand
porta pasteles
présentoir à gâteaux

Akazienholz geölt
acacia wood oiled
madera de acacia aceitada
bois d'acacia huilé



	Ø cm	↑ cm	€
33290	9,5	7	12,00
33291	13,0	9	16,00



Servier- und Tortenplatte „ACACIA“

cake stand
porta pasteles
présentoir à gâteaux

Akazienholz geölt
acacia wood oiled
madera de acacia aceitada
bois d'acacia huilé



	Ø cm	↑ cm	€
33292	24,0	8	39,00
33293	24,0	16	49,00
33294	33,0	8	54,00
33295	33,0	16	74,00
33296	38,5	8	66,00
33297	38,5	16	89,00



Frischhalte- Haube / cover / campana / cloche



	Ø cm	↑ cm	fits to	€
06519	21	17	33292, 33293	24,00
06520	30	22	33294, 33295	29,90
06521	36	27	33296, 33297	56,00



CLASSIC



Servier- und Tortenplatte „CLASSIC“

cake stand
porta pasteles
présentoir à gâteaux



Rand fixiert die Haube
carved edge fixes the cover
ranura para fijar bien la campana
bord rainuré pour maintenir ferme la cloche

	Ø cm	↑ cm	€
85049	21,5	9	19,00
85050	21,5	17	25,00
85051	30,5	9	28,00
85052	30,5	17	34,00
85053	37,5	9	36,00
85054	37,5	17	42,00

Frischhalte- Haube / cover / campana / cloche



	Ø cm	↑ cm	fits to	€
06519 NEW	21	17	85049, 85050	24,00
06520	30	22	85051, 85052	29,90
06521 NEW	36	27	85053, 85054	56,00

Frischhalte- Haube / cover / campana / cloche



	Ø cm	↑ cm	fits to	€
06512	30	11,5	85051, 85052	6,20



Konditorplatte

cake stand
soporte para pastel
présentoir à gâteaux

matt poliert
satin polished finish
acabado efecto satinado
poli mat effet satin



	Ø cm	↑ cm	€
00046	31	3	12,50



Servier- / Tortenplatte

cake stand
soporte para pastel
présentoir à gâteaux

Fuß hochglanzpoliert, Platte matt poliert, stabil und sehr standsicher
foot mirror polished finish, plate satin polished finish
pie pulido brillante, bandeja pulida mate
ped brillant, plateau poli satin mat



	Ø cm	↑ cm	€
00462	30	11	42,00



Servier- / Tortenplatte

cake stand
soporte para pastel
présentoir à gâteaux

matt poliert, drehbar, möbelschonende Moosgummi-Unterseite
satin polished finish, rotating, foam rubber below to save your furniture
acabado pulido satinado, giratorio, base revestida de goma para no rallar el mobiliario
poli satiné, plateau tournant, revêtement mousse sous le pied pour ne pas rayer les meubles



	Ø cm	↑ cm	€
00463	30,5	9	38,00



Servier- / Tortenplatte

cake stand
soporte para pastel
présentoir à gâteaux

Fuß matt poliert, stabil und sehr standsicher, möbelschonende Moosgummi-Unterseite
foot satin polished finish, foam rubber below to save your furniture
pie pulido con efecto satinado, base revestida de goma para no rallar el mobiliario
inox poli satin, revêtement mousse sous le pied pour ne pas rayer les meubles



	Ø cm	↑ cm	€
00464	30	11	18,50

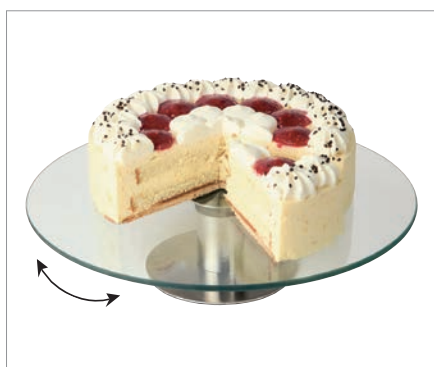

Servier- / Tortenplatte

cake stand
soporte para pastel
présentoir à gâteaux

Fuß matt poliert, drehbar, möbelschonende Moosgummi-Unterseite
foot satin polished finish, rotating, foam rubber below to save your furniture
vidrio, pie inox satinado giratorio, base de goma para proteger el mobiliario
plateau en verre, pied tournant inox poli satin, revêtement mousse sous le pied anti-rayures



	Ø cm	↑ cm	€
00444	30	7	18,90

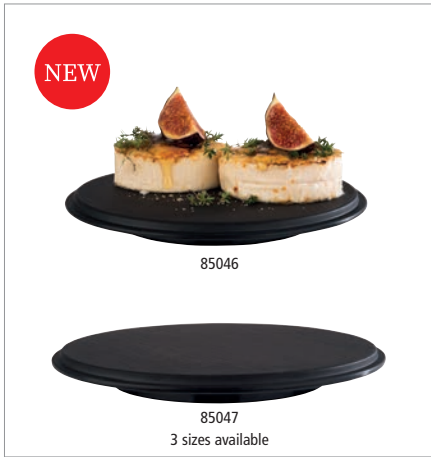

Torten- / Konditorplatte „SLATE“

cake stand
soporte para pastel
présentoir à gâteaux



Rand fixiert die Haube, mit Antirutsch-Füßchen, Schiefer Look
carved edge fixes the cover, with non-slip feet, slate look
ranura para fijar bien la campana, con pies antideslizantes, aspecto pizarra
bord rainuré pour maintenir ferme la cloche, avec pieds antidérapants, aspect ardoise



	Ø cm	↑ cm	passende Haube / suitable cover / campana adecuada / cloche appropriée	€
85046	21,5	2,5	06519 NEW	13,00
85047	30,5	3,5	06520, 06512, 6510	18,00
85048	37,5	4,0	06521 NEW	34,00



Torten- / Konditorplatte „LOOPS“

cake stand
soporte para pastel
présentoir à gâteaux



	Ø cm	↑ cm	passende Haube / suitable cover / campana adecuada / cloche appropriée	€
85033	21,5	2,5	06519 NEW	13,00
85034	30,5	3,5	06520, 06512, 06510	18,00
85035	37,5	4,0	06521 NEW	34,00

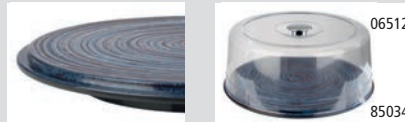

Rand fixiert die Haube, mit Antirutsch-Füßchen
carved edge fixes the cover, with non-slip feet



Torten- / Konditorplatte

cake stand
soporte para pastel
présentoir à gâteaux



Rand fixiert die Haube, mit Antirutsch-Füßchen
carved edge fixes the cover, with non-slip feet
ranura para fijar bien la campana, con pies antideslizantes
bord rainuré pour maintenir ferme la cloche, avec pieds antidérapants



	Ø cm	↑ cm	Farbe / Colour	fits to	€
00468	31	3,5		06520	15,00
00469	31	3,5		06520	15,00



Servier- und Tortenplatte „CASUAL“

cake plate
porta pasteles
présentoir à gâteaux



	Ø cm	↑ cm	€
83890	31	8	24,00
83891	31	16	30,00



Servier- und Tortenplatte „CASUAL“

cake plate
porta pasteles
présentoir à gâteaux



	cm	↑ cm	€
83892	31 x 31	8	27,00
83893	31 x 31	16	32,50

Naturschiefer



VERSIEGELT
SEALED
**PREMIUM
QUALITY**
EXTRA STARK
STRONG



00990
GN 1/1

00991
GN 1/2

00992
GN 1/3

00993
GN 1/4

GN Naturschieferplatten

GN natural slate tray
GN bandeja de pizarra natural
GN plat ardoise naturelle

hervorragende Kältespeicherung durch Naturschiefer, die Kanten der Platten sind gebrochen und nicht gesägt
excellent coldness store, food safe, waterproof
excelente conservador del frio, para reforzar la estética natural, los bordes ofrecen un canto irregular
excellent maintien du froid, les bords sont volontairement cassés pour renforcer l'esthétique naturelle



	cm	✱ mm	GN	€
00990	53,0 x 32,5	6 - 9	1/1	15,00
00991	32,5 x 26,5	6 - 9	1/2	8,40
00992	32,5 x 17,6	6 - 9	1/3	5,00
00993	26,5 x 16,2	6 - 9	1/4	4,60
00973	53,0 x 16,2	6 - 9	2/4	6,00



Naturschieferplatte

natural slate tray
bandeja de pizarra natural
plat ardoise naturelle



	cm	✱ mm	€
00996	45 x 30	6 - 9	12,00



Naturschieferplatte

natural slate tray
bandeja de pizarra natural
plat ardoise naturelle



	cm	✱ mm	€
00994	25 x 25	6 - 9	6,00
00995	30 x 30	6 - 9	9,00



Naturschieferplatte

natural slate
bandeja de pizarra natural
plateau ardoise naturelle



	cm	✱ mm	€
00941	24,0 x 15,0	6 - 9	3,90
00942	26,5 x 20,5	6 - 9	6,00
00945	47,0 x 10,0	6 - 9	6,00
00988	30,0 x 12,0	6 - 9	4,00

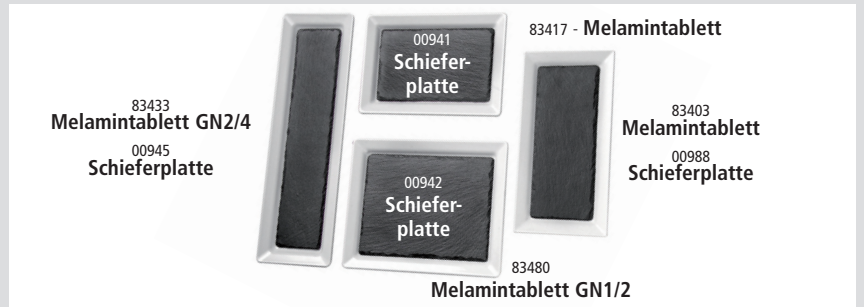

GN 1/1 Naturschieferplatte „HOCHSTAPLER“

GN 1/1 natural slate tray
GN 1/1 bandeja de pizarra natural
GN 1/1 plat ardoise naturelle



	cm	↑ cm	✱ mm	€
00966	53 x 32,5	6	6 - 9	32,00



Griffe verchromt, 4 cm Nutzhöhe
chrome plate handles, 4 cm distance



Naturschieferplatte

natural slate tray
bandeja pizarra natural
plat ardoise naturelle



mit Absatz Ø 6 cm
with hole Ø 6 cm
con agujero Ø 6 cm
avec trou Ø 6,0 cm

	cm	✱ mm	€
00986	25 x 12	6 - 9	3,90

passende Gläser:
82310, 82312, 82314, 82316



Naturschieferplatte

natural slate tray
bandeja pizarra natural
plat ardoise naturelle



mit 3 Absätzen, Ø 6 cm
with 3 holes, Ø 6 cm
con 3 agujeros, Ø 6 cm
avec 3 trous, Ø 6 cm

	cm	✱ mm	€
00987	28 x 10	6 - 9	5,40

passende Gläser:
82310, 82312, 82314, 82316



Naturschieferplatte „STARTER“

natural slate tray
bandeja de pizarra natural
plat ardoise naturelle carré



	cm	✱ mm	€
00937	20 x 10	6 - 9	2,90



Naturschieferplatte / Untersetzer

natural slate tray
bandeja de pizarra natural
plateau ardoise naturelle



mit 2 Absätzen Ø 6 cm
with 2 holes Ø 6 cm
con 2 agujeros Ø 6 cm
avec 2 trous Ø 6 cm

	cm	✱ mm	€
00971	15 x 8	6 - 9	3,00



Naturschieferplatte

natural slate tray
bandeja de pizarra natural
plat ardoise naturelle



	Ø cm	✱ mm	€
00968	22	6 - 9	4,90
00969	28	6 - 9	7,00
00998	33	6 - 9	8,00
00999	38	6 - 9	12,00



Tortenplatte / Servierplatte drehbar

cake stand
soporte para pastel
présentoir à gâteaux



	Ø cm	↑ cm	✱ mm	€
00975	32	2,5	6 - 9	16,00



drehbar
rotating



Rolltop-Set, 3-teilig

rolltop set, 3 pcs.
rolltop, set de 3
rolltop, set de 3



1 Edelmetalltablett Ø 38 cm + 1 Naturschieferplatte Ø 33 cm + 1 Rolltophaube Ø 38 cm
1 stainless tray Ø 38 cm + 1 natural slate tray Ø 33 cm + 1 rolltop cover Ø 38 cm
1 bandeja de acero inoxidable Ø 38 cm + 1 bandeja de pizarra natural Ø 33 cm + 1 tapa abatible Ø 38 cm
1 plat inox 38 cm + 1 plat ardoise naturelle 33 cm + 1 cloche 38 cm

	Ø cm	↑ cm	€
01000	38	24	44,00



3-stufige Etagère

3-tier tray
bandeja con tres alturas
étagère carré 3 hauteurs

Naturschiefer, Akazienholz
natural slate tray, wood akazie
bandeja de pizarra natural, madera de acacia
plateau ardoise naturelle, bois d'acacia



	∅ cm	↑ cm	* mm	€
00960	30 / 25 / 20	34	6 - 9	26,00



2-stufige Etagère

2-tier tray
bandeja dos alturas
étagère carré 2 hauteurs

Naturschiefer
natural slate tray
bandeja de pizarra natural
plateau ardoise naturelle



	∅ cm	↑ cm	* mm	€
00989	25 / 20	24	6 - 9	13,20



Naturschieferplatte, 2-teilig

natural slate tray, 2 pcs. set
bandeja de pizarra natural y campana
plateau ardoise naturelle et cloche en verre
mit Glashaube
with glass cover
con tapa de cristal
avec cloche en verre



	∅ cm	↑ cm	* mm	€
00984	10,5	8	6 - 9	8,00



Naturschieferplatten, 4er Set

natural slate tray, 4 pcs. set
bandeja pizarra natural, set de 4
plat ardoise naturelles, set de 4



	cm	* mm	pcs.	€
00997	10 x 10	6 - 9	4	8,00



GENUSSPALETTE



GN 1/1 Servierbrett „GENUSSPALETTE“

GN 1/1 serving board
GN 1/1 tabla de servir
GN 1/1 planche de service

HOLZ
WOOD



Genusspalette im Kleinformat, Birke
mini serving palett, birch
tabla de servir, formato pequeno, abedul
planche de service, petit format, bouleau

	cm	↑ cm	GN	€
00879	53 x 32,5	3	1/1	29,00



Servierbrett „GENUSSPALETTE“

serving board
tabla de servir
planche de service

HOLZ
WOOD



Genusspalette im Kleinformat, Birke
mini serving palett, birch
tabla de servir, formato pequeno, abedul
planche de service, petit format, bouleau

	cm	↑ cm	€
00880	20 x 12	3	8,80
00881	30 x 20	3	10,40
00882	40 x 15	3	13,40

Wachspapier „SNACKHOLDER“ / greaseproof paper squares
papel alimenticio para cucurucho / papier alimentaire pour cornet

	cm	pcs.		€
40670	42 x 25	500	Motiv: Zeitung	57,00
40671	42 x 25	500	blank	31,00
40672	42 x 25	500	Motiv: rote Karos / red	57,00
40673	42 x 25	500	Motiv: blaue Karos / blue	57,00
40674	30 x 20	500	Motiv: Fast Food / black	37,00





mit Absatz Ø 5 cm
with hole Ø 5 cm

Servierbrett, 2-tlg.
serving board, 2 pcs. set
tabla de servir, set de 2
planche de service, set de 2

SCHIEFER
SLATE

HOLZ
WOOD



2-teilig:
1 Holzbrett aus Akazienholz + 1 Naturschieferplatte
1 wood board made of acacia wood + 1 natural slate tray
1 tabla de madera de acacia + 1 pizarra natural
1 planche en bois d'acacia + 1 ardoise naturelle

	cm	↑ cm	€
00814	28 x 17,5	2	14,00



00897

00898

40635

00899

Servierbrett
serving board
tabla de servir
planche de service



Servierbrett aus geöltem Akazienholz
serving board made of oiled acacia wood
tabla de servir de madera de acacia aceiteada
planche en bois avec plateau en bois d'acacia huilé

	cm	↑ cm	€
00897	30 x 15	2	12,00
00898	30 x 18	2	14,00
00899	35 x 25	2	20,00



00810

00811

00812

00813

Servierbrett, 2-tlg.
serving board, 2 pcs. set
tabla de servir, set de 2
planche de service, set de 2

SCHIEFER
SLATE

HOLZ
WOOD



2-teilig:
Ein rustikales Servierbrett aus Akazienholz,
ausgestattet mit einer Naturschieferplatte
wood board oiled acacia with a slate tray
tabla de madera de acacia con una bandeja de pizarra natural
planche en bois d'acacia avec un plateau en ardoise naturelle

	cm	↑ cm	€
00810	26 x 18	2	13,00
00811	33 x 20	2	16,00
00812	40 x 15	2	21,00
00813	43 x 12	2	16,00

Präsentationsmöglichkeit
presentation example



00813

mit Hängeloch Ø 2 cm / with a handle-hole Ø 2 cm

NEW

**Servierbrett**

serving board
tabla de servir
planche de service

**Servierbrett aus geöltem Akazienholz**

serving board made of oiled acacia wood
tabla de servir de madera de acacia aceiteada
planche en bois d'acacia huilé

	cm	↑ cm	Griff / handle cm	€
00887	51,5 x 18	1,5	8,5	29,00

Servierbrett „AKAZIE-SCHIEFER“

serving board
tabla de servir
planche de service

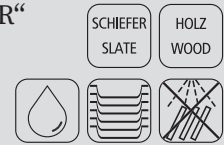

raffiniertes, rustikales Servierbrett
aus Akazienholz, ausgestattet mit einem Naturschieferstreifen
zur Kennzeichnung

wood with slate, markable
madera con pizarra, se puede marcar
bois avec ardoise, on peut mettre une inscription

	cm	↑ cm	€
00867	30,5 x 13	1,5	16,00
00868	36,5 x 15	1,5	20,00
00869	42,0 x 18	1,5	23,00



00867



00868

Servierbrett „OLIVE“

serving board
tabla de servir en madera de olivo
planche de service en bois d'olivier



Servierbrett im Naturschnitt, aus Olivenholz. Jedes Brett wird handgefertigt und geölt mit 19 mm Aufhäng Bohrung.
Alle Produkte unterscheiden sich naturbedingt in Form, Maserung und Größe!

Olive Wood is known for its versatility and striking appearance with each piece having its own unique features.

El olivo es conocido por su versatilidad y aspecto espectacular y único en cada pieza. Por su fabricación a mano de forma artesanal, todas las piezas varían en tamaño, forma y acabado, lo que hace de cada una un ejemplar único.

Le bois d'olivier est reconnu pour sa versatilité et son esthétique spectaculaire. De par leur fabrication artisanale à la main, toutes les pièces varient quant à leur taille, forme et finition, de telle sorte que chacune est un exemplaire unique.

	cm	↑ cm	Griff / handle cm	€
00870	25 x 17,0	1,5		28,00
00871	30 x 20,5	2,0		46,00
00872	35 x 24,0	2,0		56,00
00873	40 x 15,0	1,5	11	49,00
00874	44 x 20,0	2,0	12	64,00
00875	19 x 12,5	1,5	6	20,00
00876	25 x 16,0	1,5	8	30,00
00877	31 x 20,0	1,5	9	46,00



00870



00873



00875



Servierbrett „OAK“

serving board
 tabla de servir
 planche de service



aus geöltem Eichenholz, Safrille, ø 9,5 cm runde Aussparung
 made of oiled oak, with juice groove, with hole ø 9.5 cm
 de madeira de roble aceiteada, con ranura para liquidos, con agujero ø 9,5 cm
 en bois chêne huilé, avec rigole, avec trou ø 9,5 cm

	cm	↑ cm	€
00808	37 x 25	2	22,00



mit Safrinne / with juice groove



Servierbrett „OLIVE“

serving board
 tabla de servir
 planche de service



aus geöltem Olivenholz
 oiled olive wood
 de madeira de olivo aceiteada
 en bois d'olivier huilé

	cm	↑ cm	€
00905	25,5 x 16,5	1,5	9,90
00906	35,0 x 20,5	1,5	19,00



Rindenholzbrett

wood plater
 tabla de madera con corteza
 planche en bois avec écorce



Akazienholz mit Rinde, jedes Brett ein Unikat,
 vor dem Erstgebrauch mit Speiseöl behandeln

acacia wood with bark, each board unique,
 treat with cooking oil before first use
 madeira de acacia con corteza, cada tabla un ejemplar
 único, tartar con aceite de cocina antes del primer uso
 bois d'acacia avec écorce, chaque planche une modèlle unique,
 traiter avec de l'huile de caisson avant la première utilisation

	cm	↑ cm	€
00895	26 x 24,0	2	13,00
00896	30 x 28,5	2	15,00



Schale „OLIVE“

bowl
cuenco
bol



aus geöltem Olivenholz
oiled olive wood
de madera de olivo aceitada
en bois d'olivier huilé

	cm	↑ cm	ltr.	€
00843	12,0 x 7,5	2,5	0,05	7,00
00844	16,5 x 9,5	2,5	0,10	9,00



Schale „OLIVE“

bowl
cuenco
bol



aus geöltem Olivenholz
oiled olive wood
de madera de olivo aceitada
en bois d'olivier huilé

	cm	↑ cm	ltr.	€
00907	13 x 8	6,5	0,2	6,00
00908	16 x 9	7,0	0,3	9,00



Servierbrett „NARROW“

serving board
tabla de servir
planche de service



Akazienholz, mit 3 Vertiefungen Ø 6 cm
acacia wood, with 3 notches Ø 6 cm
madera de acacia, con 3 ranuras Ø 6 cm
bois d'acacia, avec 3 encoches Ø 6 cm

	cm	↑ cm	€
00878	31 x 11	2	10,00

passende Schälchen / fitting bowls / cuencos adecuados / bols apropiés

	Ø cm	↑ cm	ltr.		€
40685	6	3	0,05	stainless steel	2,00

Servierbeispiel - Lieferung ohne Schälchen
delivery without bowls



Holzbox „TABLE“

woodbox
caja madera
base bois



Akazienholz, 3 Fächer (6,5 x 6,5 cm)
acacia wood, 3 compartments (6,5 x 6,5 cm)
madera de acacia, 3 compartimentos (6,5 x 6,5 cm)
bois d'acacia, 3 compartiments (6,5 x 6,5 cm)

	cm	↑ cm	inner size cm	€
11727	23,5 x 8,5	4,5	6,5 x 6,5 je Fach / each compartment	12,00

Servierbeispiel - Lieferung ohne Gläser
delivery without glasses



NEW

Buffetbrett „PROFI“



Buffetbrett „PROFI“

board
tabla para el buffet
planche découper buffet

aus geöltem Eichenholz, Safrinne, mit Antirutsch-Füßchen

made of oiled oak, with juice groove and non slip-feet

de madera de roble aceitada, con ranura para líquidos y pies antideslizantes

en bois chêne huilé, avec rigole et pieds antidérapants



	Ø cm	↑ cm	passende Haube / suitable cover / campana adecuada / cloche appropriée	€
00815	23	4,5	6519	32,00
00805	33	4,5	6520, 6510, 6512	54,00
00816	39	4,5	6521	89,00

Frischhalte- Haube / cover / campana / cloche

	Ø cm	↑ cm	fits to	€
06512	30	11,5	85051, 85052	6,20



Frischhalte- Haube / cover / campana / cloche

	Ø cm	↑ cm	fits to	€
06519	21	17	85049, 85050	24,00
06520	30	22	85051, 85052	29,90
06521	36	27	85053, 85054	56,00



Buffetbrett „PROFI“

board
tabla para el buffet
planche découper buffet

aus geöltem Eichenholz, Safrinne, mit Antirutsch-Füßchen

made of oiled oak, with juice groove and non slip-feet

de madera de roble aceitada, con ranura para líquidos y pies antideslizantes

en bois chêne huilé, avec rigole et pieds antidérapants



	cm	↑ cm	passende Haube / suitable cover / campana adecuada / cloche appropriée	€
00807	38 x 32,0	4,5	11021, 11022, 12008, 12010	59,00
00806	58 x 37,5	4,5	11026, 11027, 11028, 11008, 11010, 11016	89,00

**Buffetbrett „XXL“**

board
tabla para el buffet
planche à découper buffet

**Buchenholz geölt, mit Antirutsch-Füßchen**

beech wood oiled, with non-slip feet
madera de haya tratada con aceite, con pies antideslizantes
bois hêtre huilé, avec pieds antidérapants

	Ø cm	↑ cm	€
00866	50	4,5	74,00

Rolltophaube / rolltop cover / campana rolltop / cloche rolltop

	Ø cm	↑ cm	€
18380	50	26	54,00

**Brezel- oder Wurstständer**

pretzel-/ sausage stand
soporte para embutidos
support à bretzel ou à saucissons

**Verkaufsständer Buchen-Holz versiegelt, bestens geeignet für die Präsentation von Brezeln, Würstchen, etc., Fuß Ø 22 cm**

beech wood, ideal to present pretzels, sausages, etc.
madera de haya, ideal para presentar fiambres, salchichones etc.
en hêtre, idéal pour bretzels ou saucissons, etc.

	Ø cm	↑ cm	€
79553	28	50	19,00

Hygieneschutz für Brezelständer / hygienic cover / cubierta higiénica antialiento / pare-haleine

	cm	↑ cm	€
11557	20 x 20 x 20	50	21,00
11558	15 x 20 x 15	50	19,00

**Hobel für Käse und Schokolade**

cheese / choco curler
rizador para queso y chocolate
frisette pour fromage et chocolat

**3-teilig: Platte Buchen-Holz versiegelt Ø 22 cm mit senkrechtem Stift + Hobel 7 cm + Haube Ø 15 x 10 cm, für Käse und Schokolade**

3 pcs. set: wooden base Ø 22 cm with vertical bolt + plough 7 cm + cover Ø 15 x 10 cm, for cheese and chocolate

set de 3: base de madera Ø 22 cm, con eje vertical de 7 cm + campana Ø 15 x 10 cm, para „rizar“ queso y chocolate

set de 3: base bois Ø 22 cm, axe vertical ht. 7 cm, cloche Ø 15 x ht 10 cm, pour „friser“ le fromage ou le chocolat.

	Ø cm	↑ cm	€
50002	22	15	16,00

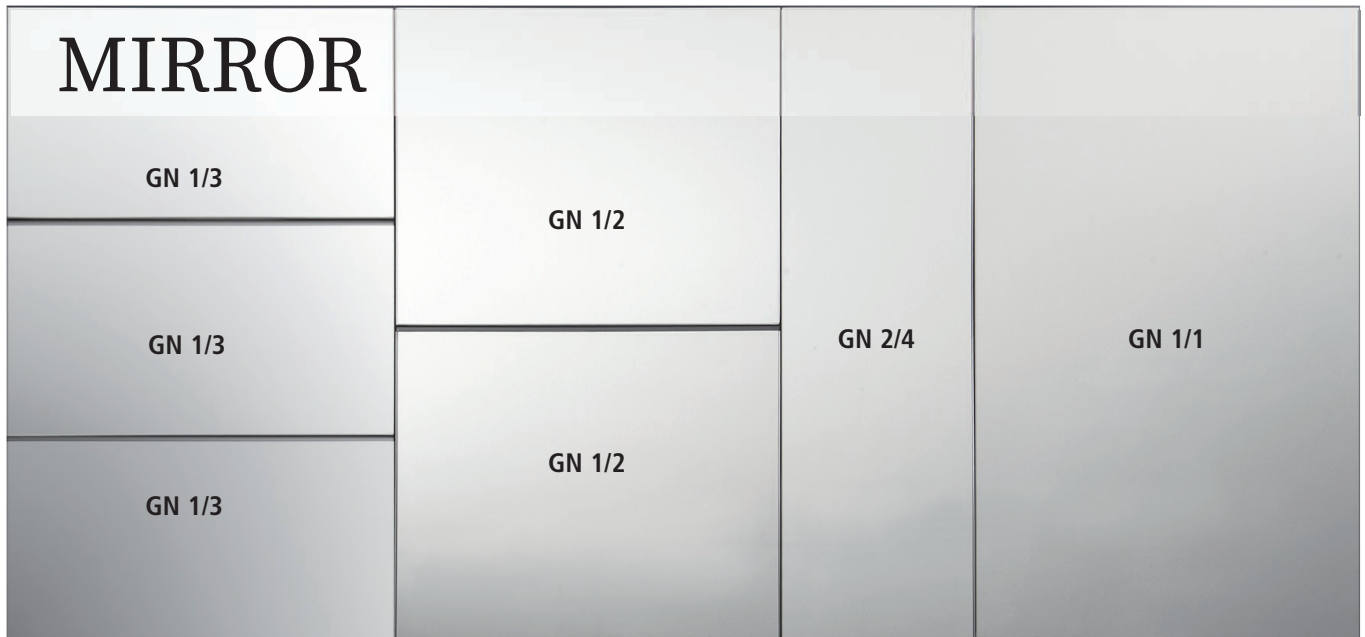

GN Glasplatte „MIRROR“

GN glass platter
GN espejos sobre vidrio
GN plateau miroir en verre

silber spiegelndes Glas, mit Antirutsch-Füßchen
silver mirror glas, non-slip feet
espejo plateado, pies antideslizantes
plateau miroir argenté, pieds antiglisse



	cm	↑ cm	GN	€
00961	53,0 x 32,5	3	1/1	23,00
00962	32,5 x 26,5	3	1/2	12,00
00963	32,5 x 17,6	3	1/3	10,50
00964	53,0 x 16,2	3	2/4	11,50

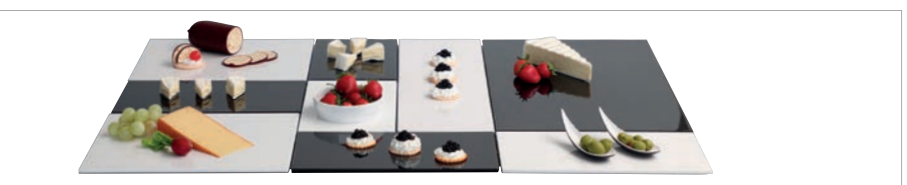

GN Tablett „ZERO“

GN tray
GN bandeja
GN plateau

glatte, hochglänzende Oberfläche
smooth and shiny surface
superficie lisa con acabado brillante
surface lisse et finition brillante



	cm	↑ cm	GN	Farbe / Colour	€
84185	53,0 x 32,5	1,5	1/1	White	34,00
84186	32,5 x 26,5	1,5	1/2	White	18,20
84187	32,5 x 17,6	1,5	1/3	White	12,80
84188	26,5 x 16,2	1,5	1/4	White	10,40
84189	53,0 x 16,2	1,5	2/4	White	20,00
84195	53,0 x 32,5	1,5	1/1	Black	34,00
84196	32,5 x 26,5	1,5	1/2	Black	18,20
84197	32,5 x 17,6	1,5	1/3	Black	12,80
84198	26,5 x 16,2	1,5	1/4	Black	10,40
84199	53,0 x 16,2	1,5	2/4	Black	20,00



GN Tablett „FRAMES“

GN tray
GN bandeja
GN plateau



	cm	↑ cm	GN	€
82355	53,0 x 32,5	2	1/1	35,00
82356	32,5 x 26,5	2	1/2	20,00
82357	32,5 x 17,6	2	1/3	17,00



Präsentationsmöglichkeit / presentation opportunity



GN Tablett

GN tray
GN bandeja
GN plateau



	cm	↑ cm	GN	€
82201	53,0 x 32,5	2,5	1/1	36,00
82202	32,5 x 26,5	2,5	1/2	20,00
82203	32,5 x 17,6	2,5	1/3	17,00
82204	53,0 x 16,2	2,5	2/4	28,00
82205	35,4 x 32,5	2,5	2/3	30,00



GN Tablett „FRAMES“

GN tray
GN bandeja
GN plateau



	cm	↑ cm	GN	€
84046	53,0 x 32,5	2	1/1	26,00
84047	32,5 x 26,5	2	1/2	14,20
84048	32,5 x 17,6	2	1/3	10,00



00510

Serviertablett „HAPPY HOUR“

tray
bandeja
plateaurutschfeste Oberfläche
non-slip surface
superfície anti deslizando
surface antidérapante

	Ø cm	↑ cm	Farbe / Colour	€
00510	32	1,5	■	20,60
00511	38	1,5	■	25,00
00515	43	1,5	■	28,90



00548

Tablett „GASTRO“

tray
bandeja
plateaurutschfeste Oberfläche
non-slip surface
superfície anti deslizando
surface antidérapante

	Ø cm	↑ cm	Farbe / Colour	€
00547	27,5	2	■	6,90
00548	35,5	2	■	8,70
00549	40,5	2	■	10,50



Tablett „BISTRO“

tray
bandeja
plateaurutschfest, mit 2 Griffmulden und Stapelrand
non-slip, two open handles, stackable edge
anti deslizando, 2 asas
antidérapant, 2 anses

	Ø cm	↑ cm	Farbe / Colour	€
84045	35,5	4,5	■	22,00



00500

00507

Bierglasträger „NONSLIP“

beer rack
bandeja para cerveza
porte verre à bièrerutschfeste Oberfläche
non-slip surface
superfície anti deslizando
surface antidérapante

	Ø cm	↑ cm	Farbe / Colour	€
00500	36	3,5	■	19,00
00501	36	3,5	■	19,00

	cm	↑ cm	Farbe / Colour	€
00506	28 x 20	1,5	■	8,50
00507	28 x 20	1,5	■	8,50



Teller mit Glashalter „COCKTAIL“

plate with glass holder
plato sujeta copas
assiette porte-verre



eignet sich besonders für Stehempfänge, einhändig nutzbar
particularly suitable for standing receptions, single-handed use
para uso en recepciones de pie, facil de usar con sólo una mano
particulièrement pour des receptions debout, utilisable avec une seule main

	cm	↑ cm	€
84620	22 x 14	1,5	3,00



	Ø cm	↑ cm	€
84621	19	1,5	3,00



Serviertablett „NONSLIP“

tray non-slip
bandeja
plateau



rutschfeste Oberfläche
non-slip surface
superficie antideslizante
surface antidérapante

	cm	↑ cm	GN	Farbe / Colour	€
00502	53,0 x 32,5	1,5	1/1		21,90
00508	46,0 x 36,0	2,0			20,80
00505	53,0 x 32,5	1,5	1/1		21,90
00503	53,0 x 37,0	1,5			25,00



Tablett

tray
bandeja
plateau



rutschfest, Holzdekor-Laminat
non-slip, coated wood
antideslizante, decoración madera láminae
antidérapant, décor bois laminé

	cm	↑ cm	€
00524	43,5 x 31,5	1,5	17,20
00525	52,0 x 39,0	1,5	21,80
00526	60,5 x 42,5	1,5	27,50



Fast Food-Tablett

snack tray
bandeja autoservicio y snacks
plateau self-service et snacks



	cm	↑ cm	GN	Farbe / Colour	€
00530	35 x 27,0	2			3,10
00535	41 x 30,5	2			4,10
00540	45 x 35,5	2			5,10
00552	53 x 32,5	2	1/1		6,20

	cm	↑ cm	GN	Farbe / Colour	€
00531	35 x 27,0	2			3,10
00536	41 x 30,5	2			4,10
00541	45 x 35,5	2			5,10
00553	53 x 32,5	2	1/1		6,20

	cm	↑ cm	GN	Farbe / Colour	€
00532	35 x 27,0	2			3,10
00537	41 x 30,5	2			4,10
00542	45 x 35,5	2			5,10
00554	53 x 32,5	2	1/1		6,20

	cm	↑ cm	GN	Farbe / Colour	€
00533	35 x 27,0	2			3,10
00538	41 x 30,5	2			4,10
00543	45 x 35,5	2			5,10
00555	53 x 32,5	2	1/1		6,20



Tablett
tray
bandeja
plateau



rutschfest, Mahagonifurnier
non-slip, woodform, mahogany
antideslizante, revestimento de caoba
antidérapant, placage en acajou

	Ø cm	↑ cm		€
00528	31,0	3,5	hoher Rand	17,20
00529	35,5	3,5	hoher Rand	21,90

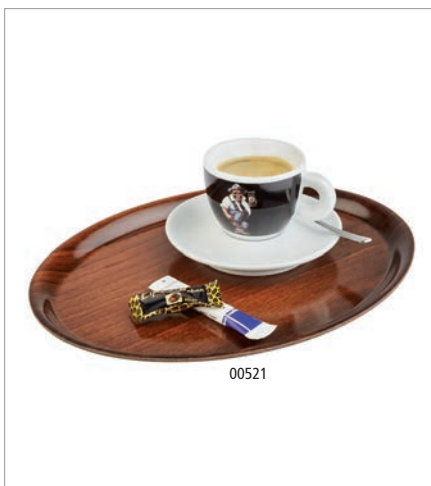

Tablett
tray
bandeja
plateau



rutschfest, Holzdekor-Laminat
non-slip, coated wood
antideslizante, limando decoracion madera
antidérapant, décor bois stratifié

	cm	↑ cm		€
00521	26 x 20	1		7,60
00522	29 x 21	1		9,90



DRESSINGTOPF-DISPLAY /-STATION

wooden station for 3 dressing pots
expositor de madeira para 3 salseras
présentoir en bois pour 3 pots à sauce

inkl. 3 Beschriftungsschilder aus Metall

incl. 3 metal labels

incl. 3 etiquetas de metal

incl. 3 étiquettes métalliques



	cm	↑ cm	€
84863	40 x 16	9	24,00



passend für 83311, 83867, 30060
suitable for 83311, 83867, 30060



Dressingtopf „PASTELL“

dressing pot
salsera
pot à sauce



	cm	↑ cm	ltr.	Farbe / Colour	€
84862	13	19,5	1,5		19,00
84860	13	19,5	1,5		19,00
84861	13	19,5	1,5		19,00

Beschriftungsetikett
siehe S. 312
labeling labels page 312

Beschriftungsetiketten, 72 Stück / labeling labels, 72 pcs. set
etiquetas, 72 pzs / étiquettes, 72 pcs.

	cm	Farbe / Colour	€
00069	8 x 4,6		10,00



mit Antirutschfüßchen
with non-slip feet
con pies antideslizantes
avec pieds antidérapants



stapelbar
stackable
apilable
empilable



Dressingtopf, doppelwandig „PROFI“

dressing pot, double wall
salsera alta, doble pared
pot à sauce, double paroi

beste Isoliereigenschaften

best insulating properties

muy aislante

très isolant



	Ø cm	↑ cm	ltr.	€
30060	13	19	1,4	29,00

Beschriftungsetiketten, 72 Stück / labeling labels, 72 pcs. set
etiquetas, 72 pzs / étiquettes, 72 pcs.

	cm	Farbe / Colour	€
00069	8 x 4,6		10,00

Beschriftungsetikett siehe S. 312
labeling labels page 312



Dressingtopf „CASUAL“
dressing pot
salsera
pot à sauce



	cm	↑ cm	ltr.	Farbe / Colour	€
83867	12	21,5	1		25,00



Dressingtopf „CASUAL“
dressing pot
salsera
pot à sauce



	cm	↑ cm	ltr.	Farbe / Colour	€
83868	12	21,5	1		25,00



Dressingtopf, doppelwandig
bowl, double wall
salsera alta, doble pared
pot à sauce, double paroi



beste Isoliereigenschaften
best insulating properties
muy aislante
très isolant

	Ø cm	↑ cm	ltr.	€
30043	15	18	1,8	41,00



Dressingtopf
dressing pot
salsera
pot à sauce



Deckel mit Löffelaussparung
cover notched for spoon
tapa agujereada para el cucharón
couverture avec espace pour la louche

	Ø cm	↑ cm	ltr.	€
83309	18,5	17	2,3	22,00
83310	17,0	15	2,0	21,00
83311	13,0	13	0,8	11,00



11101
Kühl-Akkus halten Ihre Speisen
bis zu 6 Stunden kühl
cooler keeps the food until
6 hrs. cold

Buffetvitrine

showcase
vitrina de buffet
vitrine de buffet



1 transparente Rolltophaube beidseitig aufklappbar + 1 Schale (ABS)
+ 1 Edelstahl-Tablett 39 x 28 cm + 2 Kühl-Akkus

1 transparent rolltop cover + 1 tray (ABS) + 1 stainless tray 39 x 28 cm + 2 coolers, demountable

1 tapa abatible transparente + 1 bandeja (ABS) + 1 bandeja 39x28cm + 2 enfriadores, desmontable

1 cloche transparente ouverture 2 côtés + 1 caisson (ABS) + 1 plateau inox 39 x 28 cm +

2 accumulateurs de froid, démontable

	cm	↑ cm	Farbe / Colour	€
09100	44 x 32	20,5		36,00
09102	44 x 32	20,5		36,00
09104	44 x 32	20,5		36,00

Kühlakku / cooler / acumulador de frío / accumulateur de froid

	cm	↑ cm	pcs.	€
11101	16 x 7,5	2	4	4,70

Edelstahl-Tablett / stainless steel tray / bandeja de acero inoxidable / plateau inox

	cm	€
90902	39 x 28	6,00



11101
Kühl-Akkus halten Ihre Speisen
bis zu 6 Stunden kühl
cooler keeps the food until
6 hrs. cold

Thermo Tablett-Set

thermo tray
bandeja termo
caisson thermo



1 stabile Schale + 1 Edelstahl-Tablett + 2 Kühlakkus + 1 Frischhaltehaube

1 plastic tray + 1 stainless tray + 2 coolers + 1 cover

1 bandeja de plástico + 1 bandeja inox + 2 acumuladores + 1 campana

1 plateau plastique + 1 plateau inox + 2 accumulateurs de froid + 1 cloche

	cm	↑ cm	€
09090	43 x 29	14	19,00

Kühlakku / cooler / acumulador de frío / accumulateur de froid

	cm	↑ cm	pcs.	€
11101	16 x 7,5	2	4	4,70

Haube / cover / campana / cloche

	cm	↑ cm	€
90901	43 x 29	14	4,40

Edelstahl-Tablett / stainless steel tray / bandeja de acero inoxidable / plateau inox

	cm	€
90902	39 x 28	6,00



Buffetvitrine „DOPPELDECKER“

showcase
vitrine de buffet, 2 alturas
vitrine de buffet double



2 transparente Rolltopphauben beidseitig aufklappbar + 2 Edelstahl-Tablets 39 x 28 cm
+ 4 Kühl-Akkus, platzsparend lagerbar

2 transparent rolltop cover + 2 tray 39 x 28 cm + 4 coolers, demountable, space saving

2 campanas abatibles por ambos lados + 2 bandejas 39 x 28 cm + 4 acumuladores,
desmontable, ahorra espacio

2 cloches transparentes abattantes 2 côtés + 2 plateaux 39 x 28 cm + 4 accumulateurs de
froid, gain d'espace

	cm	↑ cm	Farbe / Colour	€
09200	44 x 32	44	White	72,00
09202	44 x 32	44	Blue	72,00
09204	44 x 32	44	Black	72,00

Kühlakku / cooler / acumulador de frío / accumulateur de froid

	cm	↑ cm	pcs.	€
11101	16 x 7,5	2	4	4,70

Edelstahl-Tablett / stainless steel tray / bandeja de acero inoxidable / plateau inox

	cm	€
90902	39 x 28	6,00



Thermo Tablett-Set

thermo tray
bandeja termo
caisson thermo



1 stabile Schale + 1 Edelstahl-Tablett + 2 Kühlakkus + 1 Frischhaltehaube

1 plastic tray + 1 stainless tray + 2 coolers + 1 cover

1 bandeja de plástico + 1 bandeja inox + 2 acumuladores + 1 campana

1 plateau plastique + 1 plateau inox + 2 accumulateurs de froid + 1 cloche

	Ø cm	↑ cm	€
09093	35	15	19,00

Kühlakku / cooler / acumulador de frío / accumulateur de froid

	cm	↑ cm	pcs.	€
11101	16 x 7,5	2	4	4,70

**Kühl-Akkus halten Ihre Speisen
bis zu 6 Stunden kühl
cooler keeps the food until
6 hrs. cold**

**Buffet-Set „FOCUS“**

buffet set
set de buffet
présentoir pour le buffet

4-teilig: Box, Tablett, 2 Kühlakkus

4 pcs.: box, tray, 2 cooler

set de 4.: box, bandeja, 2 enfriadores

swt de 4: caisson, 2 plateau, bac



	cm	↑ cm	Farbe / Colour	€
09000	43,5 x 32,5	6		54,00
09001	43,5 x 32,5	6		54,00

Edelstahltablett / tray / bandeja / plateau

	cm	↑ cm	€
09010	43,5 x 32,5	1,5	19,00

Holzschneidebrett / wooden board / tablero de madera / planche à découper

	cm	↑ cm	€
09016	43,5 x 32,5	2	46,50

Basisteil / base / base / base

	cm	↑ cm	Farbe / Colour	€
09011	42,5 x 31,5	6		22,00
09012	42,5 x 31,5	6		22,00

Rolltophaube „PURE“ / rolltop cover / campana abatible / cloche basculante

	cm	↑ cm	€
09013	44 x 33,5	17	24,00

Kühlakku / cooler / acumulador de frío / accumulateur de froid

	cm	↑ cm	€
10791	25 x 19	2,5	7,20

**Buffet-Set „FOCUS“**

buffet set
set de buffet
présentoir pour le buffet

3-teilig: Box, Tablett, 1 Kühlakku

3 pcs.: box, tray, 1 cooler

set de 3.: box, bandeja, 1 enfriador

set de 3: caisson, 1 plateau, bac



	Ø cm	↑ cm	Farbe / Colour	€
09002	38	6		40,00
09003	38	6		40,00

Edelstahltablett / tray / bandeja / plateau

	Ø cm	↑ cm	€
09020	38	1,5	15,00

Basisteil / base / base / base

	Ø cm	↑ cm	Farbe / Colour	€
09021	37	6		19,00
09022	37	6		19,00

Rolltophaube / rolltop cover / campana abatible / cloche basculante

	Ø cm	↑ cm	€
09023	38	20	21,00



11540



11010

Buche, wasserfest lackiert
beech wood lacquered



10791

**Kühl-Akkus halten Ihre Speisen
bis zu 6 Stunden kühl**
cooler keeps the food until
6 hrs. cold

Buffetvitrine „TOP FRESH GN 1/1“

refrigerated buffet display
expositor buffet frío
plateau buffet froid



4-teilig: 1 Holzbox mit Kunststoffwanne + 1 Tablett GN 1/1 + 2 Kühlakkus

4 pcs. set: 1 woodbox with plastic insert + 1 stainless tray GN 1/1 + 2 coolers

set de 4: 1 base madeira + 1 bandeja inox GN 1/1 + 2 acumuladores de frío

set de 4: 1 base bois + 1 plateau inox GN 1/1 + 2 accus de froid (cloche non incluse)

	cm	↑ cm	€
11540	60 x 41	5	174,00

GN Rolltophaube / GN rolltop cover / GN campana rolltop / GN cloche rolltop

	cm	↑ cm	GN	€
11008	53 x 32,5	19	1/1 Gold-Griff	59,90

GN Rolltophaube / GN rolltop cover / GN campana rolltop / GN cloche rolltop

	cm	↑ cm	GN	€
11010	53 x 32,5	19	1/1 Chrom-Griff	59,90

Kühlakku / cooler / acumulador de frío / accumulateur de froid

	cm	↑ cm	€
10791	25 x 19	2,5	7,20



11541

Buche, wasserfest lackiert
beech wood lacquered



10791

**Kühl-Akkus halten Ihre Speisen
bis zu 6 Stunden kühl**
cooler keeps the food until
6 hrs. cold

Buffetvitrine „DOPPELDECKER“

cooling buffet display
expositor buffet frío
vitrine buffet



12-teilig: 2 Kästen Buchen-Holz versiegelt + 2 Tablett GN 1/1

+ 4 Kühlakkus + 4 Stangen, ohne Hauben

12 pcs. set: 2 beech wood boxes waterproof + 2 trays GN 1/1 + 4 coolers + 4 fittings, without covers

set de 12: 2 bases madeira tratada + 2 bandejas inox GN 1/1 + 4 enfriadores + 4 pies (campanas no incl.)

set de 12: 2 caissons bois traité (hêtre) + 2 plateaux inox GN 1/1 + 4 accus + 4 pieds (cloches non incluses)

	cm	↑ cm	€
11541	60 x 41	36	verchromte Stäbe / chrome plated fittings pies cromados / pieds chromés 329,00

GN Rolltophaube / GN rolltop cover / GN campana rolltop / GN cloche rolltop

	cm	↑ cm	GN	€
11008	53 x 32,5	19	1/1 Gold-Griff	59,90

GN Rolltophaube / GN rolltop cover / GN campana rolltop / GN cloche rolltop

	cm	↑ cm	GN	€
11010	53 x 32,5	19	1/1 Chrom-Griff	59,90

Kühlakku / cooler / acumulador de frío / accumulateur de froid

	cm	↑ cm	€
10791	25 x 19	2,5	7,20



11542

Buche, wasserfest lackiert
beech wood lacquered



11542

Kühl-Akkus halten Ihre Speisen
bis zu 6 Stunden kühl
cooler keeps the food until
6 hrs. cold



10791

Kühltablett „TOP FRESH RUND“

refrigerated buffet display
expositor buffet frío redondo
présentoir buffet



3-teilig: 1 Holzbox mit Kunststoffwanne + 1 Edelstahl-Tablett Ø 38 cm + 1 Kühlakku

3 pcs. set: 1 woodbox with plastic insert + 1 stainless tray Ø 38 cm + 1 cooler

set de 3: 1 caja madera + 1 bandeja inox Ø 38 cm + 1 acumulador de frío

set de 3: 1 base bois + 1 plateau inox Ø 38 cm + 1 accumulateur de froid

	Ø cm	↑ cm	cl	€
11542	48	6		174,00

Rolltophaube / rolltop cover / campana abatible / cloche basculante

	Ø cm	↑ cm		€
18388	38	20	mit verchromtem Kugelgriff	21,00

Rolltophaube / rolltop cover / campana abatible / cloche basculante

	Ø cm	↑ cm		€
18387	38	20	mit vergoldetem Kugelgriff	21,00

Kühlakku / cooler / acumulador de frío / accumulateur de froid

	cm	↑ cm		€
10791	25 x 19	2,5		7,20



11543

Buche, wasserfest lackiert
beech wood lacquered



10791

Kühl-Akkus halten Ihre Speisen
bis zu 6 Stunden kühl
cooler keeps the food until
6 hrs. cold

Buffetvitrine „DOPPELDECKER“

double refrigerated buffet display
expositor de buffet redondo doble
présentoir buffet froid, double



11-teilig: 2 Rahmen Buchen-Holz versiegelt + 2 Edelstahl-Tablets Ø 38 cm

+ 2 Kühlakkus + 2 Kunststoffschalen + 3 Stangen, ohne Hauben

11 pcs. set: 2 beech wood boxes waterproof + 2 stainless trays Ø 38 cm

+ 2 cooler + 2 plastic deep trays + 3 fittings, without covers

set de 11: 2 bases madera + 2 bandejas inox aprox. 38cm

+ 2 acumuladores + 2 cubetas plástico + 3 varas (campanas no incl.)

set de 11: 2 caissons bois traité (hêtre) + 2 plateaux inox approx. 38 cm

+ 2 accus + 2 bacs plastique + 3 barres (cloches non incluses)

	Ø cm	↑ cm		€
11543	48	38	verchromte Stäbe / chrome fittings pies cromados / pieds chromés	289,00

Rolltophaube / rolltop cover / campana abatible / cloche basculante

	Ø cm	↑ cm		€
18388	38	20	mit verchromtem Kugelgriff	21,00

Rolltophaube / rolltop cover / campana abatible / cloche basculante

	Ø cm	↑ cm		€
18387	38	20	mit vergoldetem Kugelgriff	21,00

Kühlakku / cooler / acumulador de frío / accumulateur de froid

	cm	↑ cm		€
10791	25 x 19	2,5		7,20

**Buffetvitrine „TOP FRESH GN 1/1“**

cooling buffet display
expositor buffet frío
présentoir buffet



5-teilig: 1 Edelstahl-Tablett GN 1/1 + 2 Kühlakkus + 1 Edelstahl-Schale + 1 Acrylrahmen, ohne Haube

5 pcs. set: 1 stainless tray GN 1/1 + 2 cooler + 1 stainless deep tray + 1 frame acrylic, without cover

set de 5: 1 bandeja inox GN 1/1 + 2 acumuladores + 1 cubeta inox + 1 marco metacrilato (campana no incl.)

set de 5: 1 plateau inox GN 1/1 + 2 accus. de froid + 1 bac inox + 1 cadre plexi (cloche non-incl.)

	cm	↑ cm	€
11510	61 x 38	8	210,00

GN Rolltophaube / GN rolltop cover / GN campana rolltop / GN cloche rolltop

	cm	↑ cm	GN	€
11010	53 x 32,5	19	1/1	59,90

Kühlakku / cooler / acumulador de frío / accumulateur de froid

	cm	↑ cm	€
10791	25 x 19	2,5	7,20

**Buffetvitrine „DOPPELDECKER GN1/1“**

cooling buffet display
expositor buffet frío
présentoir buffet



14-teilig: 2 Edelstahl-Tablets GN 1/1 + 4 Kühlakkus + 2 Edelstahl-Schale + 2 Acrylrahmen + 4 verchromte Stangen, ohne Hauben

14 pcs. set: 2 stainless tray GN 1/1 + 4 cooler + 2 stainless deep trays + 2 frames acrylic + 4 chrome plated fittings, without covers

set de 14: 2 bandejas inox GN 1/1 + 4 acum. de frío 2 cubetas inox + 2 bases metacrilato + 4 varas cromadas (sin las campanas)

set de 14: 2 plateaux inox GN 1/1 + 4 accus 2 bacs inox + 2 cadres plexi + 4 barres chromées (sans les cloches)

	cm	↑ cm	€
11514	61 x 38	33	379,00

GN Rolltophaube / GN rolltop cover / GN campana rolltop / GN cloche rolltop

	cm	↑ cm	GN	€
11010	53 x 32,5	19	1/1	59,90

Kühlakku / cooler / acumulador de frío / accumulateur de froid

	cm	↑ cm	€
10791	25 x 19	2,5	7,20

**Kühltablett „TOP FRESH RUND“**

cooling plate
expositor buffet frío
présentoir buffet



4-teilig: 1 Edelstahl-Tablett Ø 38 cm + 2 Kühllakkus + 1 Edelstahl-Schale + 1 Acrylrahmen, ohne Haube

4 pcs. set: 1 stainless tray Ø 38 cm + 2 cooler + 1 stainless deep tray + 1 frame acrylic, without cover

set de 4: 1 bandeja inox 38cm + 2 acum. de frío + 1 cubeta inox + 1 base metacrilato (campana no incluída)

set de 4: 1 plateau inox 38cm + 2 accum. de froid + 1 bac inox + 1 base plexi (cloche non incl.)

	Ø cm	↑ cm	€
11512	43,5	8	174,00

Rolltophaube / rolltop cover / campana abatible / cloche basculante

	Ø cm	↑ cm	€
18388	38	20	mit verchromtem Kugelgriff 21,00

Kühllakku / cooler / acumulador de frío / accumulateur de froid

	cm	↑ cm	pcs.	€
11101	16 x 7,5	2	4	4,70

**Buffetvitrine „DOPPELDECKER“**

cooling plate
expositor de buffet doble redondo
présentoir buffet



13-teilig: 2 Edelstahl-Tablets Ø 38 cm + 4 Kühllakkus + 2 Edelstahl-Schalen + 2 Acrylrahmen + 3 verchromte Stangen, ohne Hauben

13 pcs. set: 2 stainless trays Ø 38 cm + 4 cooler + 2 stainless deep tray + 2 frames acrylic + 3 chrome plated fittings, without covers

set de 13: 2 bandejas inox 38 cm + 4 acumuladores de frío + 3 varas cromadas + 2 bases + 2 bandejas, campana no incluída

set de 13: 2 plateaux inox 38cm + 4 accum. de froid + 2 bacs inox + 2 bases plexi + 3 barres chromées (cloche non incl.)

	Ø cm	↑ cm	€
11516	43,5	33	324,00

Rolltophaube / rolltop cover / campana abatible / cloche basculante

	Ø cm	↑ cm	€
18388	38	20	mit verchromtem Kugelgriff 21,00

Kühllakku / cooler / acumulador de frío / accumulateur de froid

	cm	↑ cm	pcs.	€
11101	16 x 7,5	2	4	4,70



Kühlbox „TOP FRESH GN 1/1“

cooling plate
bandeja de frío
présentoir buffet réfrigéré



4-teilig: 1 Kühlbox + 1 Tablett GN 1/1 + 2 Kühlakkus, ohne Haube

4 pcs. set: 1 box + 1 tray GN 1/1 + 2 coolers, without cover

set de 4: 1 caja plástico blanco + 1 bandeja GN 1/1 + 2 acum. de frío, campana no incluída

set de 4: 1 caisson plastique blanc + 1 plateau GN 1/1 + 2 accum. de froid, cloche non incl.

	cm	↑ cm	Farbe / Colour	€
11503	56,5 x 35	6,5	White	94,00
11505	56,5 x 35	6,5	Black	94,00

GN Rolltophaube / GN rolltop cover / GN campana rolltop / GN cloche rolltop

	cm	↑ cm	GN	€
11008	53,0 x 32,5	19	1/1 mit vergoldetem Kreuzgriff	59,90

GN Rolltophaube / GN rolltop cover / GN campana rolltop / GN cloche rolltop

	cm	↑ cm	GN	€
11010	53 x 32,5	19	1/1 mit verchromtem Kreuzgriff	59,90

Kühlakku / cooler / acumulador de frío / accumulateur de froid

	cm	↑ cm	€
10791	25 x 19	2,5	7,20

GN Edelstahl-Tablett „PROFI LINE“ / GN tray / GN bandeja / GN plat empilable système catering

	cm	↑ cm	GN	€
11100	53 x 32,5	1,5	1/1	27,00



Kühlbox „TOP FRESH GN 1/1“

cooling box
expositor buffet frío
présentoir buffet



4-teilig: 1 Kühlbox + Tablett GN 1/1 + 2 Kühlakkus, ohne Haube

4 pcs. set: 1 box + 1 tray GN 1/1 + 2 cooler, without rolltop cover

set de 4: 1 cajón + 1 bandeja GN 1/1 + 2 enfriadores, campana no incluída

set de 4: 1 caisson inférieur + 1 plateau GN 1/1 + 2 accus, cloche non incluse

	cm	↑ cm	€
11590	56,5 x 36	8,5	220,00

GN Rolltophaube / GN rolltop cover / GN campana rolltop / GN cloche rolltop

	cm	↑ cm	GN	€
11008	53 x 32,5	19	1/1	59,90

GN Rolltophaube / GN rolltop cover / GN campana rolltop / GN cloche rolltop

	cm	↑ cm	GN	€
11010	53 x 32,5	19	1/1	59,90

Kühlakku / cooler / acumulador de frío / accumulateur de froid

	cm	↑ cm	€
10791	25 x 19	2,5	7,20



18388

11538

10791

Kühl-Akkus halten Ihre Speisen bis zu 6 Stunden kühl
cooler keeps the food until 6 hrs. cold

Kühlbox „TOP FRESH SET“

cooling plate
bandeja de frío
set frigorifère



3-teilig: 1 Box + 1 Tablett Ø 38 cm + 1 Kühllakku, ohne Haube
3 pcs. set: 1 box + 1 tray Ø 38 cm + 1 cooler, without cover
set de 3: 1 caja + 1 bandeja Ø 38 cm + 1 enfriador, sin tapa
set de 3: 1 caisson + 1 plateau Ø 38 cm + 1 accum. (livré sans la cloche)

	Ø cm	↑ cm	Farbe / Colour	€
11538	42	6	White	77,00
11533	42	6	Black	77,00

Rolltophaube / rolltop cover / campana abatible / cloche basculante

	Ø cm	↑ cm		€
18388	38	20	mit verchromtem Kugelgriff	21,00

Kühllakku / cooler / acumulador de frío / accumulateur de froid

	cm	↑ cm		€
10791	25 x 19	2,5		7,20



18388

09082

11101

Kühl-Akkus halten Ihre Speisen bis zu 6 Stunden kühl
cooler keeps the food until 6 hrs. cold

Thermo-Set

thermo set
bandeja isotérmica
set thermo



5-teilig: 1 Tablett tief + 1 Tablett flach + 2 Kühllakkus + 1 Rolltophaube
5 pcs. set: 1 deep tray + 1 tray + 2 cooler + 1 rolltop cover
set de 5: 1 bandeja inferior + 1 bandeja + 2 acumuladores frío + campana
set de 5: 1 plateau creux + 1 plateau plat + 2 accum. + 1 cloche rolltop

	Ø cm	↑ cm		€
09082	38	24		50,00

Rolltophaube / rolltop cover / campana abatible / cloche basculante

	Ø cm	↑ cm		€
18388	38	20	mit verchromtem Kugelgriff	21,00

Kühllakku / cooler / acumulador de frío / accumulateur de froid

	cm	↑ cm	pcs.	€
11101	16 x 7,5	2	4	4,70



09083

11101

Kühl-Akkus halten Ihre Speisen bis zu 6 Stunden kühl
cooler keeps the food until 6 hrs. cold

Thermo-Set

thermo set
porta tartas refrigerado
porte-gâteau réfrigéré



4-teilig: 1 Tablett tief auf Fuß + 1 Tablett flach + 2 Kühllakkus
4 pcs. set: 1 deep tray with feet + 1 tray + 2 cooler
set de 4: 1 bandeja honda con pie + 1 bandeja + 2 acumuladores de frío
set de 4: 1 plateau creux avec pied + 1 plateau plat + 2 accum.

	Ø cm	↑ cm		€
09083	38	14,5		50,00

Rolltophaube / rolltop cover / campana abatible / cloche basculante

	Ø cm	↑ cm		€
18388	38	20	mit verchromtem Kugelgriff	21,00

Kühllakku / cooler / acumulador de frío / accumulateur de froid

	cm	↑ cm	pcs.	€
11101	16 x 7,5	2	4	4,70

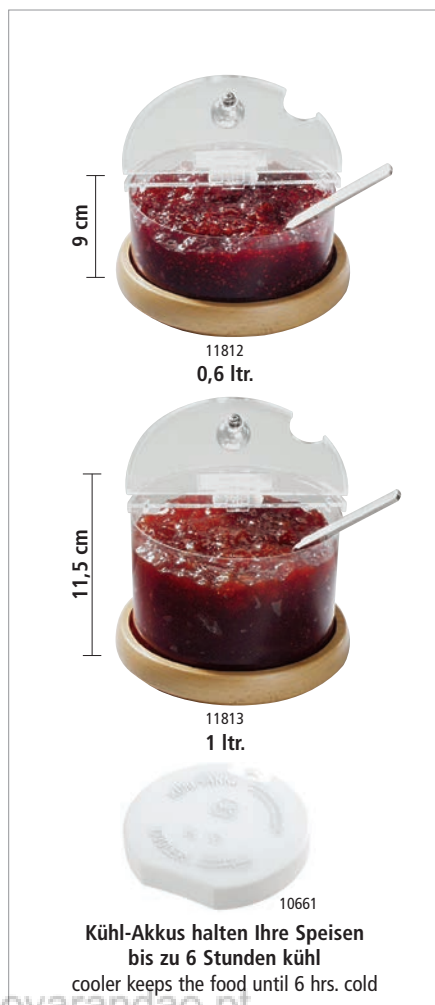
**Kühlschale Mini Holz „TOP FRESH“**

cool bowl mini holz
bol refrigerado mini madera
bol réfrigéré MINI bois

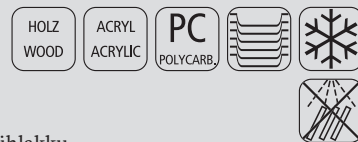

4-teilig: 1 Fuß Buchen-Holz versiegelt + 1 Schale + 1 Kühlakku
+ 1 klappbarer Deckel mit Beschriftungsschild

4 pcs. set: 1 column with food base (beech) + 1 bowl
+ 1 cooler + 1 cover with card, hinged

set de 4: 1 bol policarbonato + 1 base madera
+ 1 acum. de frío + 1 tapa con bisagra y porta etiqueta

set de 4 : 1 base en bois + 1 accum + 1 bol polycarbonate
+ 1 couvercle à charnière avec porte-étiquette

	Ø cm	↑ cm	ltr.	€
11812	14	9,0	0,6	39,00
11813	14	11,5	1,0	41,00

Ersatzschale / spare bowl / recambio bol / bol de rechange

	Ø cm	↑ cm	€
11811	14	6,5	15,40
11816	14	9,0	21,40

Schutzdeckel mit Löffelaussparung / cover / tapa / couvercle

	Ø cm	€
11868	14,5	10,40

Kühlakku / cooler / acumulador de frío / accumulateur de froid

	Ø cm	↑ cm	€
10661	10,5	2	3,20

**Kühlschale Maxi Holz „TOP FRESH“**

cool bowl maxi holz
bol refrigerado MAXI madera
bol réfrigéré MAXI bois



4-teilig: 1 Fuß Buchen-Holz versiegelt + 1 Schale + 1 Kühlakku
+ 1 klappbarer Deckel mit Beschriftungsschild

4 pcs. set: 1 column with food base (beech) + 1 bowl
+ 1 cooler + 1 cover with card, hinged

set de 4: 1 bol + 1 base madera + 1 acumulador de frío
+ 1 tapa con bisagra y porta etiqueta

set de 4: 1 base en bois + 1 accum. + 1 bol
+ 1 couvercle à charnière avec porte-étiquette

	Ø cm	↑ cm	ltr.	€
11817	22	14	2,5	94,00
11818	22	18	4,0	102,00

Ersatzschale / spare bowl / recambio bol / bol de rechange

	Ø cm	↑ cm	€
11846	22	8	35,00
11848	22	12	44,80

Schutzdeckel mit Löffelaussparung / cover / tapa / couvercle

	Ø cm	€
11878	23,5	11,40

Kühlakku / cooler / acumulador de frío / accumulateur de froid

	Ø cm	↑ cm	€
10777	15	2,5	5,00

**Kühlschale Mini „TOP FRESH“**

cool bowl mini
bol refrigerado MINI
bol réfrigéré MINI



4-teilig: 1 Edelstahlgefäß matt + 1 Kühllakku + 1 Schale + 1 klappbarer Deckel mit Beschriftungsschild

4 pcs. set: 1 column satin polished finish + 1 cooler + 1 bowl + 1 cover with card, hinged

set de 4: 1 base acabado efecto satinado + 1 acumulador de frío + 1 tapa con porta etiqueta + 1 bol

set de 4: 1 base inox mat satiné + 1 accum. de froid + 1 couvercle à charnière avec porte étiquette + 1 bol

	Ø cm	↑ cm	ltr.	€
11810	14	9,0	0,6	42,00
11815	14	11,5	1,0	44,00

Ersatzschale / spare bowl / recambio bol / bol de rechange

	Ø cm	↑ cm	€
11811	14	6,5	15,40
11816	14	9,0	21,40

Schutzdeckel mit Löffelaussparung / cover / tapa / couvercle

	Ø cm	€
11868	14,5	10,40

Kühllakku / cooler / acumulador de frío / accumulateur de froid

	Ø cm	↑ cm	€
10661	10,5	2	3,20

**Kühlschale Maxi „TOP FRESH“**

cool bowl maxi
bol refrigerado MAXI
bol réfrigéré MAXI



4-teilig: 1 Gefäß hochglanzpoliert + 1 Kühllakku + 1 Schale + 1 klappbarer Deckel mit Beschriftungsschild

4 pcs. set: 1 column mirror polished finish + 1 cooler + 1 bowl + 1 cover with card, hinged

set de 4: 1 base pulido acabado efecto espejo + 1 acumulador de frío + 1 tapa con porta etiqueta + 1 bol

set de 4: 1 base inox poli brillante + 1 accum. + 1 récipient + 1 couvercle à charnière avec porte-étiquette

	Ø cm	↑ cm	ltr.	€
11847	22	14	2,5	98,00
11849	22	18	4,0	102,00

Ersatzschale / spare bowl / recambio bol / bol de rechange

	Ø cm	↑ cm	€
11846	22	8	35,00
11848	22	12	44,80

Schutzdeckel mit Löffelaussparung / cover / tapa / couvercle

	Ø cm	€
11878	23,5	11,40

Kühllakku / cooler / acumulador de frío / accumulateur de froid

	Ø cm	↑ cm	€
10777	15	2,5	5,00

11845
2,5 ltr.

11875

Kühlschale Maxi „TOP FRESH“

cool bowl maxi
cuenco refrigerado MAXI
bol réfrigéré MAXI



4-teilig: 1 Gefäß hochglanzpoliert + 1 Kühlakku + 1 Glasschale
+ 1 klappbarer Deckel mit Beschriftungsschild

4 pcs. set: 1 column mirror polished finish + 1 cooler
+ 1 glass bowl + 1 cover with card, hinged

set de 4: 1 base pulido acabado efecto espejo
+ 1 acumulador de frío + 1 tapa con porta etiqueta + 1 bol vidrio

set de 4 : 1 base inox poli brilhant + 1 accum.
+ 1 bol verre + 1 couvercle à charnière avec porte-étiquette

	Ø cm	↑ cm	ltr.	€
11845	23	14	2,5	76,00

Schale / bowl / cuenco / bol

	Ø cm	↑ cm	ltr.	€
11875	23	10,5	2,5	4,20

Schutzdeckel mit Löffelaussparung / cover / tapa / couvercle

	Ø cm	€
11878	23,5	11,40

Kühlakku / cooler / acumulador de frío / accumulateur de froid

	Ø cm	↑ cm	€
10777	15	2,5	5,00



83696

83705

83920

Schale „CASUAL MAXI“

bowl
cuenco
bol



	Ø cm	↑ cm	ltr.	Farbe / Colour	€
83696	10	4,5	0,15	White	2,80
83698	12	5,5	0,25	White	3,40
83700	14	6,5	0,50	White	4,00
83704	20	9,2	1,80	White	8,40
83702	23	10,5	2,50	White	9,40

	Ø cm	↑ cm	ltr.	Farbe / Colour	€
83697	10	4,5	0,15	Black	2,80
83699	12	5,5	0,25	Black	3,40
83701	14	6,5	0,50	Black	4,00
83705	20	9,2	1,80	Black	8,40
83703	23	10,5	2,50	Black	9,40

Deckel „FLOAT“ mit Löffelaussparung / cover, with notched for spoons / tapa, con espacio para la cuchara / couvercle, avec encoche pour la louche

	Ø cm	↑ cm	fits to	€
83920	20,5	1,3	83704, 83705	8,20



Glaskaraffe

glass carafe
jarra de vidro
carafe en verre



Deckel aus Edelstahl matt poliert
lid made of matt polished stainless steel
tapa de acero inoxidable pulido mate,
couvreclre en acier inox poli mat

	Ø cm	↑ cm	ltr.	€
10721	8	25	1,0	12,00
10722	8	32	1,2	14,00



Ausgießer für tropffreies Ausgießen
spout for drip-free pouring



Glaskaraffe „ICEBLUE“

glass carafe
jarra de vidro
carafe en verre

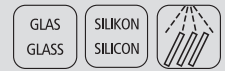

	Ø cm	↑ cm	ltr.	€
10723	8	30	0,8	19,00



inkl. Stopfen mit Silikondichtung
incl. stopper with silicone gasket



Glaskaraffe

glass carafe
jarra de vidro
carafe en verre



Deckel aus Edelstahl matt poliert, mit integriertem Auffangsieb für Kerne oder Eis
lid made of matt polished stainless steel, with integrated strainer for cores or ice
tapa de acero inoxidable pulido mate, con filtro integrado para los huesos o el hielo
couvreclre en acier inox poli mat, avec filtre intégré pour les pépins ou la glace

	Ø cm	↑ cm	ltr.	€
10792	10	26	1,5	16,00



Deckel mit Doppelfunktion
Lid with double function



Glaskaraffe

glass carafe
jarra de vidro
carafe en verre



	Ø cm	↑ cm	ltr.	€
10745	11	25,5	1,6	4,90



0,9 ltr.

Glaskaraffe „LINES“

glass carafe
jarra de vidro
carafe en verre

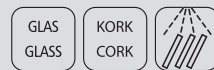

	Ø cm	↑ cm	ltr.	€
10738	8	27	0,9	13,00



Detailansicht
detail view „LINES“



inkl. Korkdeckel
incl. cork cover

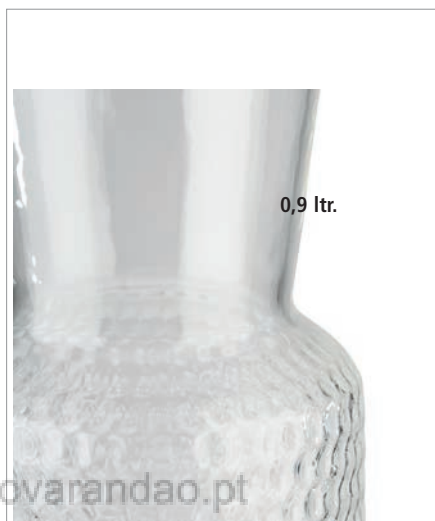

0,9 ltr.

Glaskaraffe „DOTS“

glass carafe
jarra de vidro
carafe en verre



	Ø cm	↑ cm	ltr.	€
10739	8	27	0,9	13,00



Detailansicht
detail view „DOTS“



inkl. Korkdeckel
incl. cork cover



0,8 ltr.



Detailansicht
detail view „WABE“

Glaskaraffe „WABE“

glass carafe
jarra de vidro
carafe en verre



	Ø cm	↑ cm	ltr.	€
10741	8	28	0,8	16,00



HOLZ
WOOD

SILIKON
SILICON

inkl. Holzkorken mit Silikondichtung
incl. wooden cork with silicone gasket



0,8 ltr.



Detailansicht
detail view „DIAMOND“

Glaskaraffe „DIAMOND“

glass carafe
jarra de vidro
carafe en verre



	Ø cm	↑ cm	ltr.	€
10742	8	28	0,8	16,00



HOLZ
WOOD

SILIKON
SILICON

inkl. Holzkorken mit Silikondichtung
incl. wooden cork with silicone gasket

**Glaskaraffe „RINGS“**

glass carafe
jarra de vidro
carafe en verre



	Ø cm	↑ cm	ltr.	€
10743	8	28	0,8	16,00



HOLZ
WOOD

SILIKON
SILICON

inkl. Holzkorken mit Silikondichtung
incl. wooden cork with silicone gasket

**Flasche „STRIPES“**

bottle
botella
bouteille



	Ø cm	↑ cm	ltr.	€
10748	9	28,5	1	9,00

**Flasche „STRIPES“**

bottle
botella
bouteille



	Ø cm	↑ cm	ltr.	€
10749	9	28,5	1	9,00

**Kühlkaraffe, 3-teilig „COOL“**

cooling carafe, 3 pcs. set
jarra fría, set de 3
pichet rafraichisseur, set 3



1 Glaskaraffe mit Edelstahl-Ausgießer, öffnet und schließt selbstständig
+ 1 verchromter Fuß + 1 Kühlakku, werden bis zu 4 Stunden gekühlt

1 glass carafe with stainless steel pourer, open / closing autonomous
+ 1 chrome plated base + 1 cooling pack, up to 4 hours cooled beverages

1 botella de vidrio con vertedor inox y silicona, con autocierre
+ 1 base cromada + 1 placa de frío que mantiene las bebidas frescas hasta unas 4 horas

pichet en verre avec insert verseur inox et silicone, fermeture automatique
+ socle chromé + accumulateur de froid pour maintenir les boissons froides jusqu'à 4 heures

	Ø cm	↑ cm	ltr.	€
10762	16	27	1,4	31,00

Glasflasche / glass carafe / jarra de vidro / pichet verre

	Ø cm	↑ cm	€
10761	16	26	22,00

Kühlakku rund, schwarz / cooler round, black / cooler / accumulateur de froid, noir

	Ø cm	↑ cm	€
10752	10,5	2	4,60

**Glaskaraffe**

glass carafe
jarra
pichet en verre



der Deckel öffnet sich beim Ausgießen automatisch
cover opens automatically while pouring
la tapa se abre automáticamente durante el vertido
le couvercle s'ouvre seul pendant le service, résistant à la chaleur

	Ø cm	↑ cm	ltr.	€
10766	9,5	29	1	19,90

**Glaskaraffe**

glass carafe
jarra
pichet verre



Deckel aus Edelstahl matt poliert
stainless steel cover
tapa de acero inoxidable
couvercle inox



Ausgießer für tropffreies ausgießen
spout for drip-free pouring

	Ø cm	↑ cm	ltr.	€
10764	9,5	27	1,5	22,50

**Saft- / Wasserkanne**

juice / water pitcher
jarra de zumo / agua
pichet à eau ou jus de fruit



mit Eiswasser-Röhre
with water ice tube
con tubo para hielo
avec tube à glaçons plongeant pour réfrigérer

	cm	↑ cm	ltr.	€
10769	19 x 13	27	2,8	21,00

**Saftkanne**

juice pitcher
jarra de zumo
pichet à jus de fruit



mit Eiswasser-Röhre
with water ice tube
con tubo para hielo
avec tube à glaçons plongeant pour réfrigérer

	Ø cm	↑ cm	ltr.	€
10770	18	29	3	24,00



2,0 ltr.

Saftkanne

juice pitcher
jarra de zumo
pichet à jus de fruit



	Ø cm	↑ cm	ltr.	€
10775	12	26	2	20,00



2,5 ltr.

Saftkanne

juice pitcher
jarra de zumo
pichet à jus de fruit



	Ø cm	↑ cm	ltr.	€
10776	14	29	2,5	17,00



1,5 ltr.

Pitcher

pitcher
jarra
pichet



	Ø cm	↑ cm	ltr.	€
93105	13	21	1,5	8,40



1,6 ltr.

10771

10774

Karaffe / Kanne

bottle
botella
bouteille

**Schraubdeckel mit aromadichtem Verschluss**

screwed lid, aroma-tight

tapón de rosca, impide la fuga de aromas

bouchon à visser, ne laisse pas passer les arômes

	Ø cm	↑ cm	ltr.	Farbe / Colour	€
10771	11	30	1,6		13,20
10772	11	30	1,6		13,20
10773	11	30	1,6		13,20
10774	11	30	1,6		13,20



Kühlbox „FROSTY“

bottle cooler
enfriador de botellas
rafraichisseur de bouteilles

mit herausnehmbarem Einsatz für 4 Flaschen

with removable insert for 4 bottles
con inserto extraíble para 4 botellas
avec insert amovible pour 4 bouteilles



Abb. ohne Einsatz
illustration without insert

	cm	↑ cm	ltr.	hole ø cm	€
93230	27 x 27	15	7,5	11	32,00



Wein- / Sektkühler

wine / champagne bowl
cubitera para vino y cava
seau à vin ou champagne

gehämmerte Oberfläche mit 2 seitlichen Eingriffen

hammered surface with 2 handles on the side
superficie martillada con 2 asas
surface martelée avec 2 poignées



	cm	↑ cm	ltr.	Farbe / Colour	€
36111	30 x 23,5	23	7	copper-look	49,00



Wein- / Sektkühler

wine / champagne bowl
cubitera para vino y cava
seau à vin ou champagne

gehämmerte Oberfläche mit 2 seitlichen Eingriffen

hammered surface with 2 handles on the side
superficie martillada con 2 asas
surface martelée avec 2 poignées



	cm	↑ cm	ltr.	Farbe / Colour	€
36112	30 x 23,5	23	7	gunmetal-look	49,00



Getränkewanne „TIN“

beverage tub
barreño botellines
bassine à glace

Metall verzinkt, mit Kunststoffeinsatz

galvanised metal, with plastic insert
metal galvanizado, con inserto de plástico
métal galvanisé, avec insert en plastique



	Ø cm	↑ cm	ltr.	Farbe	€
36100	40 x 28	22	11	copper-look	29,00
36101	40 x 28	22	11	black-metal-look	24,00



mit Kunststoffeinsatz
with plastic insert
con inserto de plástico
avec insert en plastique



Kreidestift zum Beschriften
chalk marker for writing
S. 312



10328

Milch- / Universalkanne

milk / water jug
jarra leche / agua
pichet à eau / lait



außen hochglanzpoliert, innen matt poliert
outside mirror polished finish, inside satin polished finish
exterior brillante, interior satinado
extérieur brillant, intérieur mat satiné

	Ø cm	↑ cm	ltr.	€
10328	8,0	10,0	0,35	6,80
10329	9,0	11,5	0,60	10,00
10330	10,5	13,0	0,80	13,50
10331	12,0	16,5	1,30	18,50
10332	13,5	18,0	2,00	24,00



10334

Milch-/Universalkanne „ANTIHAFT“

non stick jug
jarra antiadherente
pichet antiadhésif



PTFE-antihftbeschichtet, perfekt für die Herstellung von Milchschaum
PTFE coated, for baristas frothing hot milk
revestimiento PTFE, ideal para espume de leche
revêtement PTFE, idéal pour faire mousser le lait

	Ø cm	↑ cm	ltr.	€
10334	8,0	10,0	0,35	13,80
10335	9,0	11,5	0,6	16,90
10336	10,5	13,0	0,8	22,40

**Teebrühsieb**

snap mesh tea ball
infusor de té, pinza con malla
boule à thé avec pince



matt poliert, mit feinem Sieb, aufklappbar
satin polished finish, with fine mesh, hinged
acabado pulido efecto satinado, con malla fina, con bisagra
inox mat, maille fine, avec charnière

	Ø cm	→ cm	€
74750	4,5	15,5	2,10



0,3 ltr.

Teekanne „ASIA“

teapot
tetera
théière



aus Gusseisen, innen emailliert, hält den Tee lange warm, kein nachbittern, ideal für zwei Tassen
made of cast iron, keeps the tea warm for a long time, no bitterness, ideal for two cups
hecho de hierro fundido, mantiene el té caliente durante mucho tiempo, sin amargar, ideal para dos tazas
en fonte, maintient le thé chaud pendant longtemps, pas d'amertume, idéal pour deux tasses

	cm	↑ cm	ltr.	€
10990	12,5 x 11	12,5	0,3	19,00

BEVERAGE DISPENSERS



7 ltr.

Getränkespender „OLD FASHIONED“

beverage dispenser
dispensador de bebidas
distributeur de boissons



dicke, stabile Wände, weite Öffnung für große Zutaten, Gestell schwarz
thick, stable walls, a wide opening for large ingredients, black stand
tiene paredes gruesas y estables, amplia abertura para ingredientes grandes, soporte negro
des murs épais et stables, large ouverture pour de grands ingrédients, support noir

	Ø cm	↑ cm	ltr.		€
10409	27	50,5	7	inkl. Gestell / incl. stand	54,00

Ersatz-Gestell zu Getränkenspender / stand for beverage dispenser / soporte de recambio para el dispensador de bebidas / support de remplacement pour le distributeur de boissons

	Ø cm	↑ cm		€
10410	27	31,5		14,00

Ersatz-Glas zu Getränkenspender ohne Zapfhahn / replacement glass for beverage dispenser without tap / cristal de recambio para el dispensador de bebidas sin grifo / vitre de rechange pour le distributeur de boissons sans robinet

	Ø cm	↑ cm	ltr.	€
10411	19	36,5	7	42,00

Ersatz-Zapfhahn zu Getränkenspender / replacement tap for beverage dispenser

		€
10718		24,00



7 ltr.

Getränkespender „ASIA“

beverage dispenser
dispensador de bebidas
distributeur de boissons



dicke, stabile Wände, weite Öffnung für große Zutaten, Fuß und Deckel aus Holz
thick, stable walls, a wide opening for large ingredients, wooden stand and lid
tiene paredes gruesas y estables, amplia abertura para ingredientes grandes, soporte y tapa de madera
des murs épais et stables, large ouverture pour de grands ingrédients, support et couvercle en bois

	Ø cm	↑ cm	ltr.		€
10403	24,5	45,5	7	inkl. Gestell / incl. stand	74,00

Ersatz-Fuß zu Getränkenspender mit Anti-Rutsch-Füßchen / base to beverage dispenser with non slip feet / soporte de recambio para el dispensador de bebidas con pies antideslizantes / support de remplacement pour le distributeur de boissons avec pieds antidérapants

	Ø cm	↑ cm		€
10404	24,5	15		23,00

Ersatz-Deckel zu Getränkenspender / replacement lid for beverage dispenser / tapa de recambio para el dispensador de bebidas / couvercle de rechange pour le distributeur de boissons

	Ø cm	↑ cm		€
10405	14,0	5		8,80



Getränkespender „ELEMENT“

beverage dispenser
dispensador de bebidas
distributeur de boissons



dicke, stabile Wände, weite Öffnung für große Zutaten, Fuß und Deckel aus Beton
thick, stable walls, a wide opening for large ingredients, stand and lid made of concrete
tiene paredes gruesas y estables, amplia abertura para ingredientes grandes, soporte y tapa de hormigón
des murs épais et stables, large ouverture pour de grands ingrédients, support et couvercle en béton

	Ø cm	↑ cm	ltr.		€
10400	22	45	7	inkl. Gestell / incl. stand	89,00

Ersatz-Fuß zu Getränkenspender mit Anti-Rutsch-Füßchen / base to beverage dispenser with non slip feet / soporte de recambio para el dispensador de bebidas con pies antideslizantes / support de remplacement pour le distributeur de boissons avec pieds antidérapants

	Ø cm	↑ cm		€
10401	22	17		38,00

Ersatz-Deckel zu Getränkenspender / replacement lid for beverage dispenser / tapa de recambio para el dispensador de bebidas / couvercle de rechange pour le distributeur de boissons

	Ø cm	↑ cm		€
10402	14	2,5		8,80



Getränkespender „GINGER“

beverage dispenser
dispensador de bebidas
distributeur de boissons



weite Öffnung für große Zutaten, 1 Kühlakku im Standfuß
wide opening for large ingredients, 1 cooler in the base
amplia abertura para ingredientes grandes, 1 acumulador de frío en la base
large ouverture pour de grands ingrédients, 1 accumulateur de froid dans le socle

	Ø cm	↑ cm	ltr.		€
10406	20	49,5	6	inkl. Gestell / incl. stand	194,00

Ersatz-Fuß zu Getränkenspender mit Anti-Rutsch-Füßchen

base to beverage dispenser with non slip feet
soporte de recambio para el dispensador de bebidas con pies antideslizantes
support de remplacement pour le distributeur de boissons avec pieds antidérapants

	Ø cm	↑ cm		€
10407	18	13,5		22,00

Ersatz-Deckel zu Getränkenspender / replacement lid for beverage dispenser / tapa de recambio para el dispensador de bebidas / couvercle de rechange pour le distributeur de boissons

	Ø cm	↑ cm		€
10408	20	7,5		14,00

Kühlakku / cooler / acumulador de frío / accumulateur de froid

	Ø cm	↑ cm		€
10777	15	2,5		5,00

Behälter inkl. Zapfhahn / container incl. tap / recipiente con grifo / récipient avec robinet

		ltr.		€
10703		6		157,00



10,5 ltr.

300 ml

Dichtung aus Polyethylen
seal made of polyethylene

300 ml

Getränkespender „FRUITS“

beverage dispenser
dispensador de bebidas
distributeur de boissons



dicke, stabile Wände, weite Öffnung für große Zutaten, Gestell schwarz

thick, stable walls, a wide opening for large ingredients, black stand

tiene paredes gruesas y estables, amplia abertura para ingredientes grandes, soporte negro
des murs épais et stables, large ouverture pour de grands ingrédients, support noir

	Ø cm	↑ cm	ltr.		€
10415	25	58	10,5	inkl. Gestell / incl. stand	69,00

Trinkglas „BEACH“

drinking glass / vaso / verre



	Ø cm	↑ cm	ltr.	VE	€ / pc.
10505	8,5	13,5	0,3	48	3,40

Ersatzteile Getränkenspender „FRUITS“

spare parts beverage dispenser
recambios dispensador de bebidas
pièces distributeur de boissons

Ersatz-Deckel zu Getränkenspender „FRUITS“

replacement glass for beverage dispenser / cristal de recambio
para el dispensador de bebidas / vitre de rechange pour le
distributeur de boissons



	Ø cm	↑ cm		€
10418	14	12		9,00

Ersatz-Glas zu Getränkenspender „FRUITS“ inkl. Deckel, ohne Zapfhahn

replacement glass for beverage dispenser without tap
cristal de recambio para el dispensador de bebidas sin grifo
vitre de rechange pour le distributeur de boissons sans robinet

	Ø cm	↑ cm	ltr.	€
10417	25	42	10,5	24,00

Ersatz-Zapfhahn zu Getränkenspender

replacement tap for beverage dispenser
grifo de recambio para el dispensador de bebidas
robinet de rechange pour le distributeur de boissons



		€
10718		24,00

Ersatz-Gestell zu Getränkenspender

stand for beverage dispenser
soporte de recambio para el dispensador de bebidas
support de remplacement pour le distributeur de boissons



	Ø cm	↑ cm		€
10416	26	19		22,00

Trinkglas „OLD FASHIONED“

drinking cup
vaso
gobelet



	Ø cm	↑ cm	ltr.	VE	€ / pc.
10520	7	12,5	0,3	6	1,20



4,5 ltr.

300 ml

Getränkespender „FRESH WHITE“

beverage dispenser
dispensador de bebidas
distributeur de boissons

Behälter mit Edelstahlzapfhahn und Holzdeckel, stabiles Glas,
inkl. weißem Holzstandfuß und Kork-Untersetter

container with stainless steel tap and wooden cover, solid glass,
incl. white wooden base and cork coaster

recipiente con grifo de acero inoxidable y tapa de madera, cristal sólido,
incl. pie de madera blanca y posavasos de corcho

réceptier avec robinet en acier inox et couvercle en bois, verre robuste,
incl. pied en bois blanc et soucoupes de liège

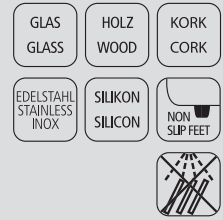

	cm	↑ cm	ltr.		€
10420	23 x 23	56,5	4,5	inkl. Gestell / incl. stand	76,00

Trinkbecher „CRYSTAL“
drinking cup / vaso / gobelet

	Ø cm	↑ cm	ltr.	VE	€ / pc.
10501	8	12,5	0,3	48	2,80

Ersatzteile Getränkenspender „FRESH WHITE“

spare parts beverage dispenser
recambios dispensador de bebidas
pièces distributeur de boissons

Ersatz-Deckel zu Getränkenspender „FRESH WHITE“

replacement lid for beverage dispenser
tapa de recambio para el dispensador de bebidas
couvercle de rechange pour le distributeur de boissons



	Ø cm	↑ cm	Farbe / Colour	€
10423	11,5	1,5	White	5,00

Ersatz-Glas zu Getränkenspender „FRESH WHITE“, inkl. Zapfhahn

replacement glass for beverage dispenser with tap
cristal de recambio para el dispensador de bebidas con grifo
vitre de rechange pour le distributeur de boissons avec robinet



	Ø cm	↑ cm	ltr.	€
10422	15,5	42,0	4,5	48,00

Ersatz-Untersetter aus Kork zu Getränkenspender „FRESH WHITE“

replacement cork coaster for beverage dispenser
posavasos de corcho de recambio para el dispensador de bebidas
soucoupes de liège de rechange pour le distributeur de boissons



	Ø cm	↑ cm	€
10424	16,5	1,5	5,00

Ersatz-Gestell zu Getränkenspender „FRESH WHITE“

stand for beverage dispenser
soporte de recambio para el dispensador de bebidas
support de remplacement pour le distributeur de boissons



	cm	↑ cm	Farbe / Colour	€
10421	23 x 23	14	White	20,00



4,5 ltr.

300 ml

4,5 ltr.

Glas inkl. Zapfhahn

Getränkespender „FRESH WOOD“

beverage dispenser
dispensador de bebidas
distributeur de boissons

Behälter mit Edelstahlzapfhahn und Korkdeckel, stabiles Glas, inkl. Holzstandfuß und Kork-Untersetzer

container with stainless steel tap and cork cover, solid glass, incl. wooden base and cork coaster

recipiente con grifo de acero inoxidable y tapa de corcho, cristal sólido, incl. pie de madera y posavasos de corcho

réceptif avec robinet en acier inox et couvercle de liège, verre robuste, incl. pied en bois et soucoupes de liège

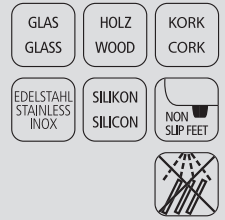

	cm	↑ cm	ltr.		€
10430	23 x 23	56,5	4,5	inkl. Gestell / incl. stand	76,00

Trinkbecher „CRYSTAL“ drinking cup / vaso / gobelet



	Ø cm	↑ cm	ltr.	VE	€ / pc.
10501	8	12,5	0,3	48	2,80

Tropfenschale drip tray aro anti-goteo anneau coupe-gouttes



	Ø cm	↑ cm	Farbe / Colour	€ / pc.
10851	9,5	1,5		6,50

Ersatzteile Getränkspender „FRESH WOOD“

spare parts beverage dispenser
recambios dispensador de bebidas
pièces distributeur de boissons

Ersatz-Deckel zu Getränkspender „FRESH WOOD“ replacement lid for beverage dispenser tapa de recambio para el dispensador de bebidas couvercle de rechange pour le distributeur de boissons



	Ø cm	↑ cm	Farbe / Colour	€
10428	11,5	1,5		5,00

Ersatz-Glas zu Getränkspender „FRESH WOOD“, inkl. Zapfhahn replacement glass for beverage dispenser with tap cristal de recambio para el dispensador de bebidas con grifo vitre de rechange pour le distributeur de boissons avec robinet



	Ø cm	↑ cm	ltr.	€
10422	15,5	42,0	4,5	48,00

Ersatz-Untersetzer aus Kork zu Getränkspender „FRESH WOOD“ replacement cork coaster for beverage dispenser posavasos de corcho de recambio para el dispensador de bebidas soucoupes de liège de rechange pour le distributeur de boissons



	Ø cm	↑ cm		€
10424	16,5	1,5		5,00

Ersatz-Gestell zu Getränkspender „FRESH WOOD“ stand for beverage dispenser soporte de recambio para el dispensador de bebidas support de remplacement pour le distributeur de boissons



	cm	↑ cm	Farbe / Colour	€
10426	23 x 23	14		20,00



7,5 ltr.

300 ml

7,5 ltr.

Glas inkl. Zapfhahn

Getränkespender „NORDIC WHITE“

beverage dispenser
dispensador de bebidas
distributeur de boissons

Behälter mit Edelstahlzapfhahn und Holzdeckel, stabiles Glas,
inkl. weißem Holzstandfuß und Kork-Untersetzer

container with stainless steel tap and wooden cover, solid glass,
incl. white wooden base and cork coaster

recipiente con grifo de acero inoxidable y tapa de madera, cristal sólido,
incl. pie de madera blanca y posavasos de corcho

réceptif avec robinet en acier inox et couvercle en bois, verre robuste,
incl. pied en bois blanc et soucoupes de liège

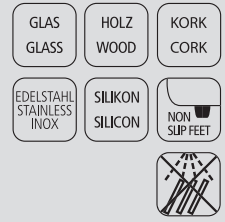

	cm	↑ cm	ltr.		€
10425	23 x 23	60,5	7,5	inkl. Gestell / incl. stand	76,00

Trinkbecher „CRYSTAL“
drinking cup / vaso / gobelet



	Ø cm	↑ cm	ltr.	VE	€ / pc.
10501	8	12,5	0,3	48	2,80

Tropfenschale
drip tray
aro anti-goteo
anneau coupe-gouttes



	Ø cm	↑ cm	Farbe / Colour	€ / pc.
10851	9,5	1,5	██████	6,50

Ersatzteile Getränkspender „NORDIC WHITE“

spare parts beverage dispenser
recambios dispensador de bebidas
pièces distributeur de boissons

Ersatz-Deckel zu Getränkspender „NORDIC WHITE“
replacement lid for beverage dispenser
tapa de recambio para el dispensador de bebidas
couvercle de rechange pour le distributeur de boissons avec robinet



	Ø cm	↑ cm	Farbe / Colour	€
10423	11,5	1,5	██████	5,00

Ersatz-Glas zu Getränkspender „NORDIC WHITE“, inkl. Zapfhahn
replacement glass for beverage dispenser with tap
cristal de recambio para el dispensador de bebidas con grifo
vitre de rechange pour le distributeur de boissons avec robinet



	Ø cm	↑ cm	ltr.	€
10427	17	46	7,5	50,00

Ersatz-Untersetzer aus Kork zu Getränkspender „NORDIC WHITE“
replacement cork coaster for beverage dispenser
posavasos de corcho de recambio para el dispensador de bebidas
soucoupes de liège de rechange pour le distributeur de boissons



	Ø cm	↑ cm	€
10424	16,5	1,5	5,00

Ersatz-Gestell zu Getränkspender „NORDIC WHITE“
stand for beverage dispenser
soporte de recambio para el dispensador de bebidas
support de remplacement pour le distributeur de boissons



	cm	↑ cm	Farbe / Colour	€
10421	23 x 23	14	██████	20,00



7,5 ltr.

300 ml

7,5 ltr.

Glas inkl. Zapfhahn

Getränkespender „NORDIC WOOD“

beverage dispenser
dispensador de bebidas
distributeur de boissons

Behälter mit Edelstahlzapfhahn und Korkdeckel, stabiles Glas,
inkl. Holzstandfuß und Kork-Untersetzer

container with stainless steel tap and cork cover, solid glas,
incl. wooden base and cork coaster

recipiente con grifo de acero inoxidable y tapa de corcho, cristal sólido,
incl. pie de madera y posavasos de corcho

réipient avec robinet en acier inox et couvercle de liège, verre robuste,
incl. pied en bois et soucoupes de liège

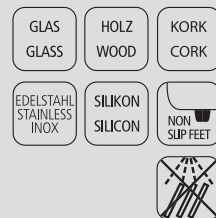

	cm	↑ cm	ltr.		€
10435	23 x 23	60,5	7,5	inkl. Gestell / incl. stand	76,00

Trinkbecher „CRYSTAL“
drinking cup / vaso / gobelet



	Ø cm	↑ cm	ltr.	VE	€ / pc.
10501	8	12,5	0,3	48	2,80

Ersatzteile Getränkspender „NORDIC WOOD“

parts beverage dispenser
recambios dispensador de bebidas
pièces distributeur de boissons

Ersatz-Deckel zu Getränkspender
replacement lid for beverage dispenser
tapa de recambio para el dispensador de bebidas
couvercle de rechange pour le distributeur de boissons



	Ø cm	↑ cm		€
10428	11,5	1,5		5,00

Ersatz-Glas zu Getränkspender „NORDIC WOOD“, inkl. Zapfhahn
replacement glass for beverage dispenser with tap
cristal de recambio para el dispensador de bebidas con grifo
vitre de rechange pour le distributeur de boissons avec robinet



	Ø cm	↑ cm	ltr.	€
10427	17	46	7,5	50,00

Ersatz-Untersetzer aus Kork zu Getränkspender „NORDIC WOOD“
replacement cork coaster for beverage dispenser
posavasos de corcho de recambio para el dispensador de bebidas
soucoupes de liège de rechange pour le distributeur de boissons



	Ø cm	↑ cm		€
10424	16,5	1,5		5,00

Ersatz-Gestell zu Getränkspender „NORDIC WOOD“
stand for beverage dispenser
soporte de recambio para el dispensador de bebidas
support de remplacement pour le distributeur de boissons



	cm	↑ cm	Farbe / Colour	€
10426	23 x 23	14		20,00



inkl.
Zapfhahn
7 ltr.

Getränkespender
beverage dispenser
dispensador de bebidas
distributeur de boissons



dicke, stabile Wände, weite Öffnung für große Zutaten
thick, stable walls, a wide opening for large ingredients
tiene paredes gruesas y estables, amplia abertura para ingredientes grandes
des murs épais et stables, large ouverture pour de grands ingrédients

	Ø cm	↑ cm	ltr.	€
10855	20	30,5	7	52,00



Tropfenschale (2-tlg.)
drip tray
aros anti-goteo
anneaux coupe-gouttes



	Ø cm	↑ cm	Farbe / Colour	€
10851	9,5	1,5		6,50
10853	9,5	1,5		6,50



10500
0,15 ltr.

10501
0,30 ltr.

10502
0,50 ltr.

Trinkbecher „CRYSTAL“
drinking cups
vasos
gobelets

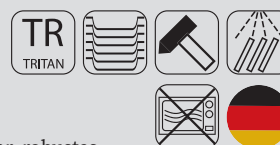

Kristallglas-Optik, vielseitig einsetzbar, robustes, unzerbrechliches Material, ideal in sensiblen Bereichen wie Pool, Spa, Beach und Wellness einzusetzen, BPA-frei
crystal-glass-look, can be used in versatile ways, a solide and unbreakable material, ideal to be used in pool, spa, beach and wellness areas, bpa-free

look de vidrio, se pueden utilizar de muchas maneras diferentes, material sólido e irrompible, ideal para el uso en áreas como piscina, spa, playa y bienestar, libre de BPA

look de verre de cristal, peuvent être utilisés de différentes façons, matériau robuste et incassable, idéal pour une utilisation dans des zones comme la piscine, le spa, la plage et le bien-être, sans BPA

	Ø cm	↑ cm	ltr.	VE	€ / pc.
10500	7	9,5	0,15	48	2,00
10501	8	12,5	0,30	48	2,80
10502	9	15,5	0,50	48	3,20



12 ltr.

Kaffeedispenser „ROYAL“

coffee dispenser
dispensador de café
distributeur de café



hochglanzpoliert, für warme Getränke, stabil und standfest, inkl. 1 Brennpastenbehälter
mirror polished finish, for warm drinks, solid and stable, incl. 1 burner holder
acabado brillante para bebidas calientes, sólido y estable, incluye un calentador
brillant, pour boissons chaudes, avec 1 brûleur, robuste et stable

	cm	↑ cm	ltr.	€
11667	28 x 28	65	12	256,00



10,5 ltr.

Kaffeedispenser „HAPPY HOUR“

coffee dispenser
dispensador de café
distributeur de café



hochglanzpoliert, für warme Getränke, stabil und standfest, inkl. 1 Brennpastenbehälter
mirror polished finish, for warm drinks, solid and stable, incl. 1 burner holder
acabado pulido brillante para bebidas calientes, sólido y estable, incluye un calentador
brillant, pour boissons chaudes, avec 1 brûleur, robuste et stable

	cm	↑ cm	ltr.	€
11672	31 x 33,5	54,5	10,5	190,00

Hahn / tap / grifo / robinet

11671	25,00
-------	-------

Elektro-Heizelement / heating unit / resistencia / résistance

	cm	↑ cm	€
12287	21 x 20	6	98,00



Saftdispenser „TOP FRESH“

juice dispenser
dispensador de zumo
distributeur à jus de fruit



hochglanzpoliert, Kühlung durch 2 Kühlakkus von oben und unten
mirror polished finish, cooling with 2 cooling elements from the top and base

base inox brillante, con 2 acum. de frio, 1 arriba y 1 en la base

base inox poli brillant, 2 plaques de froid (1 dans le couvercle, 1 dans le socle)

	cm	↑ cm	ltr.	€
10800	21 x 32	43	4	229,00
10700	23 x 35	52	6	324,00



Saftdispenser DUO „TOP FRESH“

juice dispenser
dispensador de zumo
distributeur à jus de fruit



hochglanzpoliert, Kühlung durch 2 Kühlakkus von oben und unten

mirror polished finish, cooling with 2 cooling elements from the top and base

base inox brillante, con 2 acum. de frio, 1 arriba y 1 en la base

base inox poli brillant, 2 plaques de froid (1 dans le couvercle, 1 dans le socle)

	cm	↑ cm	ltr.	€
10720	42 x 32	52	2 x 6	479,00



Saft- und Milchdispenser MIX „TOP FRESH“

juice and milk dispenser
dispensador mixto zumo y leche
distributeur mixte à lait et à jus de fruit



6 Liter Saftbehälter, 5 Liter Milchkanne, Kühlung durch Kühlakkus von oben und unten

6 liters juice container, 5 liters milkcan, cooling with cooling elements from the top and base

recipiente de zumo 6 litros, recipiente de leche 5 litros, 2 enfriadores récipient à jus 6 l, récipient à lait 5 l, plaques de froid

	cm	↑ cm	ltr.	€
10760	42 x 35	52	6 + 5	710,00



Saftdispenser WOOD „TOP FRESH“

juice dispenser
dispensador de zumo
distributeur à jus de fruit



Buchen-Holz versiegelt, Kühlung durch 2 Kühlakkus von oben und unten (nur 10730)

beech wood, waterproof, cooling with 2 cooling elements from the top and base (only 10730)

madera de haya con tratamiento anti humedad, 2 acumuladores de frío, 1 en la base y 1 en la tapa (solamente 10730)

bois de hêtre traité anti-humidité, 2 plaques de froid, 1 dans le couvercle, 1 dans le socle (seulement 10730)

	cm	↑ cm	ltr.	€
10820	21 x 31	44	4	250,00
10730	23 x 35	52	6	370,00



1) Deckel / cover / tapa / couvercle

	für ltr. / for ltr. / para ltr. / pour ltr.	€
10701	6	25,00
10801	4	21,00

2) Kühlakku / cooler / acumulador de frío / accumulateur de froid

	für ltr. / for ltr. / para ltr. / pour ltr.	€
10777	4 / 6	5,00

3) Behälter inkl. Zapfhahn / container incl. tap
recipiente con grifo / récipient avec robinet

	für ltr. / for ltr. / para ltr. / pour ltr.	€
10703	6	157,00
10803	4	134,00

3) Behälter ohne Zapfhahn / container without tap
recipiente sin grifo / récipient sans robinet

	für ltr. / for ltr. / para ltr. / pour ltr.	€
10704	6	118,00
10804	4	97,00

4) Non-Drip Hahn / non-drip tap / grifo anti-goteo / robinet anti-goutte

	für ltr. / for ltr. / para ltr. / pour ltr.	€
10707	6	45,00
10807	4	43,00

5) Dichtungsring / sealing ring / arandela / rondelle

	für ltr. / for ltr. / para ltr. / pour ltr.	€
10608	4 / 6	1,60

6) Einsatz / insert / aro inox / cercle inox

	für ltr. / for ltr. / para ltr. / pour ltr.	€
10708	6	4,40
10808	4	4,40

7) Standfuß 18/10 Edelstahl / column 18/10 stainless steel
base inox 18/10 / socle inox 18/10

	für ltr. / for ltr. / para ltr. / pour ltr.	€
10709	6	70,00
10809	4	52,50

8) Tropfgitter 18/10 Edelstahl / drip lattice 18/10 stainless steel
rejilla recoge gotas 18/10 / grille ramasse-gouttes 18/10

	für ltr. / for ltr. / para ltr. / pour ltr.	€
10712	6	24,00
10713	DUO	39,00
10812	4	21,00

9) Bodenplatte 18/10 Edelstahl / footing 18/10 stainless steel
base de 18/10 acero / socle inox 18/10

	für ltr. / for ltr. / para ltr. / pour ltr.	€
10710	6	47,00
10711	DUO / 6 + 6	94,00
10814	4	33,00

Zubehör / Reinigungsset - für die regelmäßige Reinigung

1x Dichtung, 2x Dichtungsring (transparent), 1x Dichtungsring (s / w)
1x seal, 2x sealing ring (transparent), 1x sealing ring (b / w)

		€
10714	für Zapfhahn 10707	3,40
10715	für Zapfhahn 10807	3,40
10716	für Zapfhahn 10907	4,50
10717	für Zapfhahn 10867	4,40



Saftdispenser WOOD DUO „TOP FRESH“

juice dispenser
dispensador de zumo
distributeur à jus de fruit

HOLZ
WOOD

EDELSTAHL
STAINLESS
INOX
18/8



SAN
KUNSTSTOFF

**Buchen-Holz versiegelt,
Kühlung durch 2 Kühllakkus von oben und unten**

beech wood, waterproof, cooling with 2 cooling elements
from the top and base

madera de haya con tratamiento anti humedad, 2 acumuladores
de frio (1 en la base y 1 en la tapa)

bois de hêtre traité anti-humidité, 2 plaques de froid (1 dans le
couvercle, 1 dans le socle)

	cm	↑ cm	ltr.	€
10740	42 x 35	52	2 x 6	579,00



Saft- und Milchdispenser WOOD DUO „TOP FRESH“

juice and milk dispenser
dispensador de zumo
distributeur à jus de fruit

HOLZ
WOOD

EDELSTAHL
STAINLESS
INOX
18/8



SAN
KUNSTSTOFF

**6 Liter Saftbehälter, 5 Liter Milchkanne, Kühlung durch
Kühllakkus von oben und unten, Buchen-Holz versiegelt**

6 liters juice container, 5 liters milkcan, cooling with cooling
elements from the top and bottom, beech wood, waterproof

madera de haya con tratamiento anti humedad, acumuladores
de frio, enfriador en la base

bois de hêtre traité anti-humidité, plaques dans le socle

	cm	↑ cm	ltr.	€
10765	42 x 35	52	6 + 5	798,00



Iso-Dispenser

insulated dispenser
dispensador isotérmico
distributeur de boisson isothermique

ABS
KUNSTSTOFF

EDELSTAHL
STAINLESS
INOX
18/8

für heiße und kalte Getränke

for hot and cold drinks

para bebidas frías y calientes

pour boissons chaudes ou froides

	Ø cm	↑ cm	ltr.	€
10788	24	42	9,5	55,00

Hahn / tap / grifo / robinet

10789				10,30
-------	--	--	--	-------



Getränkespender

beverage dispenser
dispensador de bebidas
distributeur de boissons

GLAS
GLASS

EDELSTAHL
STAINLESS
INOX



dicke, stabile Wände, weite Öffnung für große Zutaten

thick, stable walls, a wide opening for large ingredients

tiene paredes gruesas y estables, amplia abertura para
ingredientes grandes

des murs épais et stables, large ouverture pour de grands ingrédients

	Ø cm	↑ cm	ltr.	€
10855	20	30,5	7	52,00

**Saftdispenser „SUNDAY“**

juice dispenser
dispensador de zumo
distributeur à jus de fruit



matt poliert, Kühlung durch 2 Kühlakkus von oben und unten

satin polished finish, cooling with 2 cooling elements from the top and base

acabado pulido brillante, 2 acum. de frío (1 en la base y 1 en la tapa)

inox mat, 2 accus. de froid (1 socle et 1 couvercle)

	cm	↑ cm	ltr.	€
10860	21 x 35	48	6	264,00

**Saft- / Milchdispenser „SUNDAY“**

juice and milk dispenser
dispensador mixto zumo y leche
distributeur mixte à lait et à jus de fruit



matt poliert, Behälter gefrostet, Kühlung durch 2 Kühlakkus von oben und unten

satin polished finish, canister frosted look, cooling with 2 cooling elements from the top and base

inox acabado pulido mate, 1 recipiente policarbonato aspecto glaseado, 2 enfriadores en la base y en la tapa

inox mat, récipient polycarbonate opaque, 2 accus. de froid dans le socle et dans le couvercle

	cm	↑ cm	ltr.	€
10865	21 x 35	48	6	264,00

**Saftdispenser DUO „SUNDAY“**

juice dispenser
dispensador de zumo doble
distributeur à jus de fruit double



matt poliert, Kühlung durch 4 Kühlakkus von oben und unten

satin polished finish, cooling with 4 cooling elements from the top and base

inox acabado pulido mate, 4 enfriadores en la base y en la tapa

inox mat, 4 accus. de froid (socle et couvercle)

	cm	↑ cm	ltr.	€
10862	35 x 45	48	2 x 6	399,00

**Saft- / Milchdispenser DUO „SUNDAY“**

juice and milk dispenser
dispensador mixto zumo y leche
distributeur mixte à lait et à jus de fruit



matt poliert, 1 Behälter gefrostet, 1 Behälter transparent, 4 Kühlakkus von oben und unten

satin polished finish, 1 canister frosted look, 1 canister transparent, cooling with 4 cooling elements from the top and base

inox mate, 1 recipiente opaco, 1 recipiente transparente, 4 enfriadores (base y tapa)

inox mat, 1 récipient opaque, 1 récipient transparent, 4 accus. de froid (socle et couvercle)

	cm	↑ cm	ltr.	€
10864	35 x 45	48	2 x 6	399,00

Saftbehälter transparent, ohne Zapfhahn / juice canister transparent, without tap / contenedor transparente sin grifo / récipient cylindrique sans le robinet

	Ø cm	↑ cm	ltr.	€
10806	22	26	6	106,00

Milchbehälter, gefrostet, ohne Zapfhahn / milk canister, frosted look, without tap / contenedor de leche, efecto glaseado, sin grifo / récipient cylindrique mat (idéal pour le lait) sans le robinet

	Ø cm	↑ cm	ltr.	€
10805	22	26	6	111,00

Hahn / tap / grifo / robinet

				€
10867				41,50

**Milchkanne „TOP FRESH“**

milk dispenser
dispensador de leche
distributeur à lait



hochglanzpoliert, 1 Kühlakku im Standfuß, „original Milchkanne mit Henkel“

mirror polished finish, 1 cooler in base, original milkcan

inox brillante, 1 acumulador de frio en la base, recipiente „lechera“

inox poli brillant, 1 accum. de froid dans le socle, design „pot à lait“

	cm	↑ cm	ltr.	€
10830	21 x 32	39	3	279,00
10750	23 x 35	45	5	444,00

Milchkanne ohne Zapfhahn / milkcan without tapjarra de leche sin grifo / récipient à lait sans robinet

	Ø cm	↑ cm	ltr.	€
10833	16	22	3	162,00
10663	22	26	5	199,00



4 ltr. / 6 ltr.

Saftdispenser „BRIDGE“

juice dispenser
dispensador de zumo
distributeur à jus



Kühlung durch 2 Kühlakkus von oben und unten

cooling with 2 cooling elements from the top and base

2 acum. de frío 1 en la base y 1 en la tapa

2 plaques de froid 1 dans le couvercle, 1 dans le socle

	cm	↑ cm	ltr.	Farbe / Colour	€
10870	31,0 x 20	42	4		224,00
10871	35,5 x 22	50	6		264,00



inkl. 3 Magnetschilder: ORANGE, APPLE, GRAPEFRUIT
including 3 magnetic signs: ORANGE, APPLE, GRAPEFRUIT



4 ltr. / 6 ltr.

Saftdispenser „BRIDGE“

juice dispenser
dispensador de zumo
distributeur à jus



Kühlung durch 2 Kühlakkus von oben und unten

cooling with 2 cooling elements from the top and base

2 acum. de frío 1 en la base y 1 en la tapa

2 plaques de froid 1 dans le couvercle, 1 dans le socle

	cm	↑ cm	ltr.	Farbe / Colour	€
10872	31,0 x 20	42	4		224,00
10873	35,5 x 22	50	6		264,00



inkl. 3 Magnetschilder: ORANGE, APPLE, GRAPEFRUIT
including 3 magnetic signs: ORANGE, APPLE, GRAPEFRUIT



Milchkanne „TOP FRESH“

milk dispenser
dispensador de leche
distributeur à lait



inkl. Porzellanschild zum Beschriften, 1 Kühllakku im Fuß
incl. porcelain sign, 1 cooler in base
incluye cartelito en porcelana, 1 enfriador en la base
indicateur en porcelaine inclus, plaque de froid dans le socle

	cm	↑ cm	ltr.	€
10850	31 x 21	42	4	264,00



Milchkanne „TOP FRESH“

milk dispenser
dispensador de leche
distributeur à lait



Buchen-Holz versiegelt, inkl. Porzellanschild zum Beschriften, 1 Kühllakku im Fuß
beech wood, waterproof, incl. porcelain sign, 1 cooler in base
madera de haya, resistente al agua, incluye placa de porcelana, 1 enfriador en la base
socle bois hêtre traité, indicateur en porcelaine inclus, plaque de froid dans le socle

	cm	↑ cm	ltr.	€
10840	23 x 32,0	42	4	264,00
10757	27 x 38,5	45	8	310,00

Milchkanne Porzellan, ohne Zapfhahn / milkcan porcelain, without tap / jarra de leche sin grifo / récipient en porcelaine sans robinet

	∅ cm	↑ cm	ltr.	€
10825	18	25	4	85,00
10758	22	26	8	100,00

Deckel für 10840, 10850 / cover for 10840, 10850 / tapa para 10840, 10850 / couvercle pour 10840, 10850

10859				7,00
-------	--	--	--	------

Deckel für 10757 / cover for 10757 / tapa para 10757 / couvercle pour 10757

10759				14,30
-------	--	--	--	-------

Schild und Kette / shield and chain / placa y cadena / indicateur porcelaine avec chaînette

10756				5,00
-------	--	--	--	------

Zapfhahn / tap / grifo / robinet

10907				29,00
-------	--	--	--	-------



Milchkanne WOOD „TOP FRESH“

milk dispenser
dispensador de leche
distributeur à lait



Buchen-Holz versiegelt, 1 Kühllakku im Standfuß, „original Milchkanne mit Henkel“
beech wood, 1 cooler in base, original milkcan
madera de haya, 1 acumulador de frio en base
bois de hêtre, 1 plaque de froid dans le socle

	cm	↑ cm	ltr.	€
10835	21 x 32	39	3	305,00
10755	23 x 35	47	5	499,00

**Saftdispenser „INOX STAR“**

juice dispenser
dispensador de zumo
distributeur à jus de fruit

**Edelstahl-Crasheisröhre herausnehmbar**

stainless steel crash ice tube
con tubo inox refrigerante extraíble para hielo picado
avec tube inox réfrigérant amovible pour glace pilée

	cm	↑ cm	ltr.	€
10795	36 x 26	55	8	169,00

**Saftdispenser DUO „INOX STAR“**

juice dispenser
dispensador de zumo
distributeur à jus de fruit

**Edelstahl-Crasheisröhre herausnehmbar**

stainless steel crash ice tube
con tubo inox refrigerante extraíble para hielo picado
avec tubes inox réfrigérants amovibles pour glace pilée

	cm	↑ cm	ltr.	€
10810	36 x 52	55	2 x 8	339,00

Behälter / container / recipiente / récipient

	Ø cm	ltr.	€
10796	22	8	35,70

Deckel 18/10 Edelstahl hochglanzpoliert / cover 18/10 stainless steel mirror polished finish / tapa 18/10 inox pulido brillante / couvercle inox 18/10 poli brillant

10797	29,80
-------	-------

Crasheisröhre / crash ice tube / tubo para hielo picado / tube pour glace pilée

10798	23,80
-------	-------

Non-Drip Hahn / non-drip-tap / grifo anti-goteo / robinet anti-goutte

10799	22,00
-------	-------

Dichtungsring / sealing ring / arandela / rondelle

10793	1,50
-------	------

Silikondichtung / sealing / junta / joint

10794	2,40
-------	------

**Pump-Isolierkanne „BUDGET“**

air pot
jarra termo
bouteille isotherme



doppelwandig, Tragegriff, Dreh-Pumpknopf zur leichten Bedienung (close/open), Pumpmechanismus ist leicht zu entnehmen und zu reinigen, aufgeklappt passt die Kanne unter die gängigen Kaffeeautomaten, für heiße und kalte Getränke

double-walled, carrying handle, rotatable Push-Button for easy use (close/open), pump mechanism is easily removable for cleaning, with flipped-back lid, the air pot fits under a wide range of coffee makers, for hot and cold beverages

doble pared, con asa al lateral, tapa girable y a presión para uso fácil (close/open), el mecanismo a presión es fácil de retirar para limpiar, con la tapa abierta la jarra se puede usar con casi todas las cafeteras corrientes, para bebidas frías y calientes

double paroi, avec poignée, couvercle à visser et a pression pour facile usage (close/open), le mécanisme a pression est facile à retirer pour le nettoyage, avec la couvercle ouverte la bouteille se peut user avec toutes les machines à café courantes, pour boissons chaudes ou froides

	Ø cm	↑ cm	ltr.	Anzahl der Tassen	€
10915	13,5	32,5	2,2	17	21,00

**Pump-Isolierkanne „PREMIUM“**

air pot
jarra termo
bouteille isotherme



doppelwandig, Tragegriff, drehbarer Fuß, Pumpmechanismus und Füllstandsanzeige sind leicht zu reinigen mit 4 unterschiedlichen Inhaltsbeschriftungen für den Pumphebel (coffee, tea, hot water, decaf), aufgeklappt passt die Kanne unter die gängigen Kaffeeautomaten, für heiße und kalte Getränke

double-walled, carrying handle, pivotable feet, pump mechanism and fill level indicator is easily removable for cleaning, includes 4 different beverage signs (coffee, tea, hot water, decaf), with flipped-back lid, the air pot fits under a wide range of coffee makers, for hot and cold beverages

doble pared, con asa al lateral, pié girable, el mecanismo a presión y el indicador óptico del nivel son fácil de limpiar, con 4 etiquetas diferentes para la palanca (coffee, tea, hot water, decaf), con la tapa abierta la jarra se puede usar con casi todas las cafeteras corrientes, para bebidas frías y calientes

double paroi, avec poignée, pied pivotant, le mécanisme a pression et l'indicateur de niveau sont facile à retirer pour le nettoyage, avec 4 étiquettes différents pour la pompe (coffee, tea, hot water, decaf), avec la couvercle ouverte la bouteille se peut user avec toutes les machines à café courantes, pour boissons chaudes ou froides

	Ø cm	↑ cm	ltr.	Anzahl der Tassen	€
10916	15	37	3	24	60,00

Tropfenfänger für Pump-Isolierkanne / drip tray for air pot / recoge gotas para jarra termo / ramasse-gouttes pour bouteilles isotherme

	cm	↑ cm	€
10917	24 x 18,5	4	9,40

**Isolierkanne „ECONOMY“**

vacuum jug
jarra termo
bouteille isotherme



robuste Umhüllung mit Polypropylen-Kunststoff, Stabilglaseinsatz, Drehverschluss mit Drucktasten-Bedienung für heiße und kalte Getränke, 8 Tassen

double-walled with glass liner, screw cap with easy push-button pouring system, for hot and cold beverages, 8 cups

exterior de plástico polipropileno, interior aislante de vidrio, con tapa a rosca con cierre dosificador para bebidas frías y calientes, 8 tazas

extérieur en plastique polypropylène, intérieur avec plaque de verre, couvercle à visser, pour boissons chaudes ou froides, 8 tasses

	Ø cm	↑ cm	ltr.	Farbe / Colour	€
10913	16	20	1	White	13,60
10914	16	20	1	Black	13,60

**Isolierkanne „CLASSIC“**

vacuum jug

jarra termo

bouteille isotherme

doppelwandig, Einhandautomatik, Drehverschluss, für heiße und kalte Getränke
 double-walled, easy push-button pouring system, screw cap, for hot and cold drinks
 doble pared, se maneja con 1 mano, con tapa a rosca, para bebidas frías y calientes
 double paroi, usage à 1 main, couvercle à visser, pour boissons chaudes ou froides



	Ø cm	↑ cm	ltr.	Anzahl der Tassen	€
10910	14	19	1,0	8	15,00
10911	14	22	1,5	12	17,00
10912	14	25	2,0	16	19,00

**Isolierkanne „ADVANCED“**

vacuum jug

jarra termo

bouteille isotherme

doppelwandig, spülmaschinenfest, Einhandautomatik, aufgeklappt passt die Kanne
 unter die gängigen Kaffeeautomaten, für heiße und kalte Getränke

double-walled, dishwasher-safe, easy pouring system, with flipped-back lid,
 the air pot fits under a wide range of coffee makers, for hot and cold beverages

doble pared, resistente al lavavajillas, se maneja con 1 mano, con la tapa abierta
 la jarra se puede usar con casi todas las cafeteras corrientes, para bebidas frías y calientes

double paroi, résistante au lave-vaisselle, usage à 1 main, avec la couvercle ouverte
 a bouteille se peut user avec toutes les machines à café courantes, pour boissons chaudes ou froides



	Ø cm	↑ cm	ltr.	Anzahl der Tassen	€
10921	10,5	13,0	0,3	2,5	36,00
10922	10,5	18,0	0,6	5,0	42,00
10923	13,0	19,5	1,0	8,0	46,00
10924	13,0	23,5	1,5	12,0	52,00

NEW ACACIA



Buffetständer „ACACIA“

buffet stand
soporte para buffet
présentoir buffet



Akazienholz geölt / acacia wood oiled / madera de acacia aceitada / bois d'acacia huilé

	Ø cm	↑ cm	€
15620	20,0	10,5	22,00
15621	30,5	15,0	39,00
15622	30,5	20,0	42,00

www.ovarandao.pt

Frischhalte- Haube / cover / campana / cloche



	Ø cm	↑ cm	fits to	€
06520	30	22	15621, 15622	29,90

Frischhalte- Haube / cover / campana / cloche



	Ø cm	↑ cm	fits to	€
06512	30	11,5	15621, 15622	6,20



Buffetständer „ACACIA“

buffet stand
soporte para buffet
présentoir buffet



Akazienholz geölt / acacia wood oiled / madera de acacia aceitada / bois d'acacia huilé

	cm	↑ cm	GN	€
15623	53 x 16,2	20	2/4	44,00

GN Abdeckhaube / GN cover / GN cubierta/ GN cloche



	cm	↑ cm	✱ mm	GN	€
11044	53 x 16,2	10,5	3	2/4	20,00

Buffetständer



Buffetständer „STAR“

buffet stand
soporte para buffet
présentoire buffet



Metall, mit schwarzer Antirutschbeschichtung
metal, with black anti-slide coating
metal, con revestimiento antideslizante negro
métal, avec revêtement antidérapant noir

	↑ cm	€
33260	8	14,00
33261	12	16,50
33262	18	18,90



Buffetständer „MULTI ROUND“

buffet stand
soporte para buffet
présentoir buffet



Metall, mit schwarzer Antirutschbeschichtung
metal, with black anti-slide coating
metal, con revestimiento antideslizante negro
métal, avec revêtement antidérapant noir

	Ø cm	↑ cm	€
33269	15,5 / 18	8	10,00
33270	15,5 / 18	10	12,00
33271	15,5 / 18	18	15,00

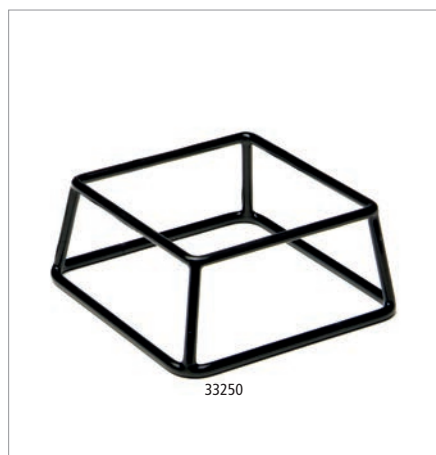

Buffetständer „MULTI“

buffet stand
soporte para buffet
présentoir buffet



Metall, mit schwarzer Antirutschbeschichtung
metal, with black anti-slide coating
metal, con revestimiento antideslizante negro
métal, avec revêtement antidérapant noir

	cm	↑ cm	€
33249	18 x 18	5	9,00
33250	18 x 18	8	12,40
33251	18 x 18	10	15,00
33252	18 x 18	18	17,50

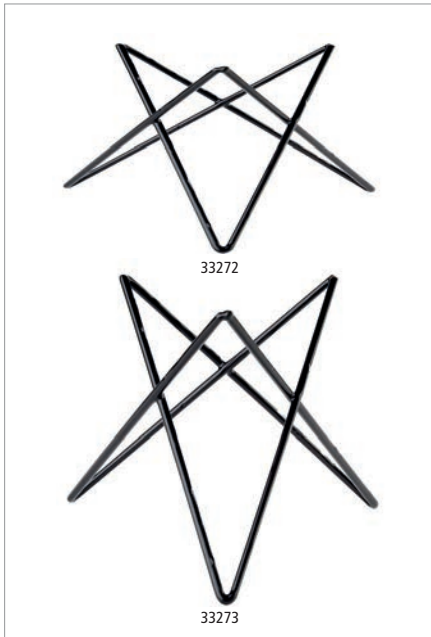

Buffetständer „PRISMA“

buffet stand
soporte para buffet
présentoir buffet



Metall, mit schwarzer Antirutschbeschichtung
metal, with black anti-slide coating
metal, con revestimiento antideslizante negro
métal, avec revêtement antidérapant noir

	Ø cm	↑ cm	€
33272	20	10,5	9,00
33273	20	20,0	13,00



Buffetständer „WOOD“

buffet stand
soporte para buffet
présentoir buffet



Akazienholz, liegend oder stehend, variable Nutzungsmöglichkeiten

acacia wood, usable by lying or standing, there are many possibilities to use
madera de acacia, se puede usar tumbado o de pie, hay diferentes opciones de utilizar
bois d'accacia, il y a différentes possibilités d'usage

	cm	↑ cm	Farbe / Colour	€
33280	20 x 20	17,5		9,80
33281	20 x 20	17,5		9,80



liegend oder stehend, variable Nutzungsmöglichkeiten
vertically or horizontally, there are variable usage possibilities



Buffetständer

buffet stand
expositor de buffet
présentoir buffet



Akazienholz
acacia wood
madera de acacia
bois d'accacia

	Ø cm	↑ cm	€
33255	15	10	15,00
33256	25	15	18,00



15515

Buffetständer „ASIA PLUS“

buffet stand
soporte para buffet
présentoir buffet



	Ø cm	↑ cm	Farbe / Colour	€
15515	38,0	16,5	■	19,00
15516	38,0	27,0	■	22,00
15517	48,5	16,5	■	22,00
15518	48,5	27,0	■	29,00

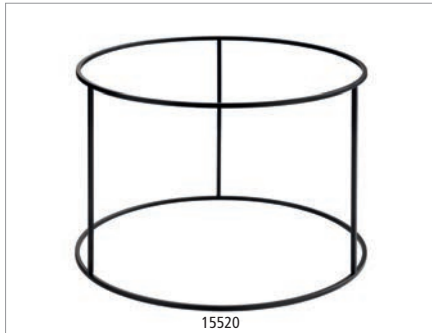

15520

Buffetständer „ASIA PLUS“

buffet stand
soporte para buffet
présentoir buffet



	Ø cm	↑ cm	Farbe / Colour	€
15519	38,0	16,5	■	16,00
15520	38,0	27,0	■	19,00
15521	48,5	16,5	■	19,00
15522	48,5	27,0	■	26,00



15513

15514

Buffetständer „ASIA PLUS“

buffet stand
soporte para buffet
présentoir buffet



	Ø cm	↑ cm	Farbe / Colour	€
15513	20,5 / 16,5	20	■	15,00
15514	20,5 / 16,5	20	■	14,00



03623

Buffetständer „KING“

buffet stand
soporte para buffet
présentoir buffet



kein Verrutschen, Arme und Boden sind mit Antirutschflächen ausgestattet, schwere standsichere Qualität, Fuß dient als Löffelablage

the arms and base are equipped with non-slip surfaces, stable quality, base serves as spoon holder
anti-deslizante: revestimiento antideslizante en las puntas de los brazos y en la base, estable y alta calidad, la base sirve como reposacuchara

antiglisse: revêtement antidérapant sur les extrémités des 3 pieds et sur la base, robuste, stable et bonne qualité, la base sert de support pour les couverts

	Ø cm	↑ cm	€
03622	15	14	36,00
03623	15	21	39,60

**Buffet-Tower**

buffet tower
torre para buffet
tour carrée pour le buffet



3-stufig, Glas in Spiegeloptik, Holz Birke dunkelbraun, Lieferung demontiert

with beech wood pillar, tempered glass mirror surface, each in knock-down packing

3 pisos, vidrio templado, eje central de madera oscura, se entrega desmontado

3 étages, verre trempé, axe central carré en bois foncé, livré non-monté

	cm	↑ cm	€
12415	25 x 25	30,5	55,00



High Tea Rack

High Tea Rack
rack de te alto
étagère à thé avec anse supérieure



Holz dunkelbraun, Edelstahlgriff, 4 große Fächer 15 x 10 x 10 cm, 3 kleine Fächer 9,5 x 9,5 x 10 cm

rubber wood in dark brown, stainless handle, 4 big compartments 15 x 10 x 10 cm, 3 small compartments 9,5 x 9,5 x 10 cm

madera marrón oscura, mango de acero inoxidable, 4 compartimentos grandes 15 x 10 x 10 cm, 3 compartimentos pequeños 9,5 x 9,5 x 10 cm

bois marron foncé, poignée inox, 4 compartiment grand 15 x 10 x 10 cm, 3 compartiment petit 9,5 x 9,5 x 10 cm

	cm	↑ cm	€
33210	34 x 10	38	33,00



Stufen-Display

tier display
expositor en escalera
présentoir en escalier



mit Schieferstruktur

with slate structure
con relieve tipo pizarra
avec relief irrégulier type ardoise

	cm	↑ cm	€
03614	40 x 18	4	20,00
03615	40 x 20	8	24,80
03616	40 x 22	12	27,80



Stufen-Display, 3-tlg.

tier display, 3 pcs.
expositor en escalera, set de 3
présentoir en escalier, set de 3



3-teiliges Set: 03614 + 03615 + 03616

3 pcs. set: 03614 + 03615 + 03616

set de 3: 03614 + 03615 + 03616

set de 3: 03614 + 03615 + 03616

	cm	↑ cm	€
03617	40 x 18 / 40 x 20 / 40 x 22	4 / 8 / 12	71,50



Stufen-Display, 3-tlg.

tier display, 3 pcs.
expositor en escalera, set de 3
présentoir en escalier, set de 3



3-teiliges Set: 03618 + 03619 + 03620

3 pcs. set: 03618 + 03619 + 03620

set de 3: 03618 + 03619 + 03620

set de 3: 03618 + 03619 + 03620

	cm	↑ cm	€
03621	20 x 18 / 20 x 20 / 20 x 22	4 / 8 / 12	42,40



passende Akazienholzplatte
fitting acacia wood panels

33206

33207

Ø 25 cm, H: 1 cm

33207

Ø 25 cm, H: 1 cm

Gestell mit abgerundeten Füßen
frame with rounded feet

Buffetgestell „BIRDCAGE“

buffet stand
soporte para buffet
présentoir buffet



Gestell aus Metall schwarz, inkl. 2 Akazienholzplatten
black metal frame, incl. 2 acacia wood panels
soporte metálico negro, incl. 2 tableros de madera de acacia
support métallique noir, avec 2 panneaux en bois d'acacia

	Ø cm	↑ cm		€
33206	26	54	2-stufig / 2-tier / 2 alturas / 2 niveaux	39,00

Ersatz-Holzplatte / spare wooden panel / tablero de madera de recambio / panneau en bois de rechange

	Ø cm	↑ cm		€
33207	25	1		14,00



Buffetgestell „LIGHT HOUSE“

buffet stand
soporte para buffet
présentoir buffet



Gestell aus Metall schwarz, inkl. 4 Glasplatten
frame made of metal, incl. 4 glass plates
soporte metálico, incl. 4 placas de vidrio
support métallique, avec 4 plaques de verre

	Ø cm	↑ cm		€
11660	33	62	4-stufig / 4-tier / 4 alturas / 4 niveaux	44,00

Ersatz-Glasplatten / spare glass / fuente de recambio vidrio / plat de rechange en verre

	Ø cm			€/Set
11653	12 / 20,5 / 25,0 / 30,5	bestehend aus 4 Glasplatten	4er Set / 4 pcs. set / set de 4 / set de 4	14,00

Buffet & Display

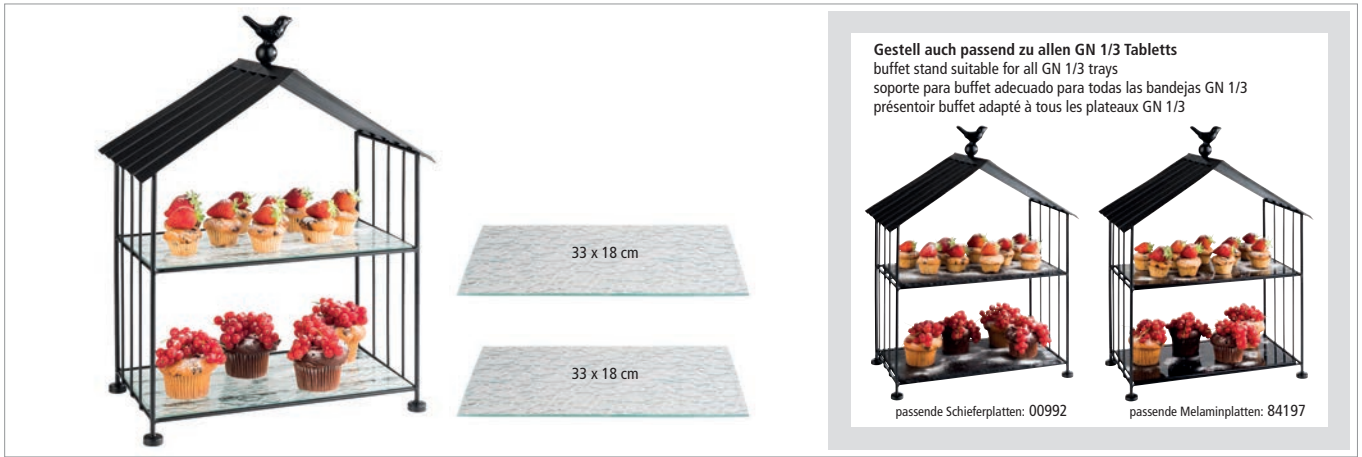

Buffetgestell „BIRD“

buffet stand
soporte para buffet
présentoir buffet



Gestell aus Metall schwarz, inkl. 2 Glasplatten je 33 x 18 cm
frame made of metal, incl. 2 glass plates, each 33 x 18 cm
soporte metálico, incl. 2 placas de vidrio, cada una 33 x 18 cm
support métallique, avec 2 plaques de verre, chacun 33 x 18 cm

	cm	↑ cm	fits to GN		€
11661	37,5 x 21	50	1/3-trays	2-stufig / 2-tier / 2 alturas / 2 niveaux	44,00

Ersatz-Glasplatten / spare glass / fuente de recambio vidrio / plat de rechange en verre

	cm				€/Set
11654	33 x 18		bestehend aus 2 Glasplatten	2er Set / 2 pcs. set / set de 2 / set de 2	16,00



Buffetgestell „TRIANGLE“

buffet stand
expositor de buffet
présentoir buffet



	cm	↑ cm		€
13966	53 x 21	50	Ahorn / maple	136,00



Buffetgestell „TRIANGLE“

buffet stand
expositor de buffet
présentoir buffet



	cm	↑ cm		€
14966	53 x 21	50	Wenge / wenge	136,00

NEW Buffetbrücke



Präsentationsmöglichkeit / presentation opportunity



Buffetbrücke
buffet bridge
puente de buffet
pont de buffet

Buffetbrücke aus Akazienholz
buffet bridge from acacia wood
puente de buffet de madera de acacia
pont de buffet en bois d'acacia



	cm	↑ cm	€
33285	45 x 17	22	42,00
33286	70 x 17	22	54,00



Lieferung erfolgt demontiert
delivery disassembled
se entrega desmontada
livraison démontée



Buffettisch MINI „VINTAGE“
buffet stand
soporte para buffet
présentoir buffet



	cm	↑ cm	fits to	€
11634	40 x 21,5	15	GN 1/3 trays	19,00



Buffetgestell
buffet stand
soporte para buffet
présentoir buffet



3-stufig, geeignet für runde und rechteckige Körbe, platzsparend zusammenklappbar
3-tier, usable for round and rectangular baskets, can be pushed together for place saving
3 alturas, apto para cestas redondas y rectangulares, se puede plegar para ahorrar espacio
3 hauteurs, pour corbeilles rondes ou rectang, la structure s'ouvre ou se ferme pour réduire l'encombrement

	cm	↑ cm	€
33232	59 x 30,5	59	18,50

Tisch- und Buffetkorb, rund „ECONOMIC“ / buffet basket, round / cesta de bufé redonda / corbeille de buffet ronde

	Ø cm	↑ cm	Farbe / Colour	€
40144	39	10		14,20



Buffetgestell, 3-tlg.

buffet stand, 3 pcs.
expositor de buffet, set de 3
présentoir buffet, set de 3



3-teilig:

- 1. Fach 40 x 23 cm x H 33 cm;
- 2. Fach 40 x 20,5 cm x H 20 cm;
- 3. Fach 40 x 18 cm x H 9 cm

3 pcs. set: 40 x 23 cm x H 33 cm; 40 x 20,5 cm x H 20 cm; 40 x 18 cm x H 9 cm
set de 3: 40 x 23 cm x H 33 cm; 40 x 20,5 cm x H 20 cm; 40 x 18 cm x H 9 cm
set de 3: 40 x 23 cm x H 33 cm; 40 x 20,5 cm x H 20 cm; 40 x 18 cm x H 9 cm

	cm	↑ cm	Farbe / Colour	€
11606	40 x 23	33	■ Wenge	149,00



Buffetgestell, 3-tlg.

buffet stand, 3 pcs.
expositor de buffet, set de 3
présentoir buffet, set de 3



3-teilig:

- 1. Fach 40 x 40 cm x H 33 cm;
- 2. Fach 40 x 37 cm x H 20 cm;
- 3. Fach 40 x 34 cm x H 9 cm

3 pcs. set: 40 x 40 cm x H 33 cm; 40 x 37 cm x H 20 cm; 40 x 34 cm x H 9 cm
set de 3: 40 x 40 cm x H 33 cm; 40 x 37 cm x H 20 cm; 40 x 34 cm x H 9 cm
set de 3: 40 x 40 cm x H 33 cm; 40 x 37 cm x H 20 cm; 40 x 34 cm x H 9 cm

	cm	↑ cm	Farbe / Colour	€
11607	40 x 40	33	■ Wenge	189,00

**Etagère „ROYAL“**

etagère
expositor
présentoir



5-teilig: 3 Edelstahl-Schalen + 2 Gestelle, einfach übereinanderstellen, einzeln nutzbar

5 pcs. set: 3 bowls + 2 frames, easy to assemble, single usable

set de 5: 3 bols + 2 soportes, fácil de montar

set de 5: 3 bols + 2 supports, montage facile

	Ø cm	↑ cm	€
24336	24 / 33 / 42	43,5	157,00

Schale / bowl / fuente / plateau

	Ø cm	↑ cm	ltr.	€
24330	24	3	0,6	23,80
24331	33	4	1,3	37,00
24332	42	5	2,5	57,00

Gestell einzeln / stand alone / pie soorte / pied seul

	Ø cm	↑ cm	€
24338	18	19	9,90
24339	24	20	14,00

**Etagère „ROYAL“**

etagère
estante
présentoir



3-teilig: 2 Edelstahl-Schalen + 1 Gestell, einfach übereinanderstellen, einzeln nutzbar

3 pcs. set: 2 bowls + 1 frame, easy to assemble, single usable

set de 3: 2 bols + 1 soorte, fácil de montar

set de 3: 2 bols + 1 support, montage facile

	Ø cm	↑ cm	€
24335	33 / 42	25	106,00
24334	24 / 33	22	67,00

Schale / bowl / fuente / plateau

	Ø cm	↑ cm	ltr.	€
24330	24	3	0,6	23,80
24331	33	4	1,3	37,00
24332	42	5	2,5	57,00

Gestell einzeln / stand alone / pie soorte / pied seul

	Ø cm	↑ cm	€
24338	18	19	9,90
24339	24	20	14,00

**Etagère**

etagère
frutero
corbeille à fruits



ergonomischer Griff, stehend auf schwarzen Antirutsch-Füßen

ergonomic handle, anti-slip-feets

asa ergonómica, pies antideslizantes color negro

anse ergonomique, pieds antidérapants noirs

	cm	↑ cm	€
30325	30 x 30	35,5	11,80

NEW

ROMANTIC

*Eyecatcher-
Guarantee*



33204



33201



33203

Serviergestell „ROMANTIC“

serving stand
soporte platos
présentoir à assiettes

EDELSTAHL
STAINLESS
INOX

für 3 Teller max. Ø 17,5 cm, innerer Ring Ø 10 cm, Lieferung ohne Teller
for 3 plates max. Ø 17,5 cm, circle inside Ø 10 cm, delivery without dishes
para 3 platos máx. Ø 17,5 cm, aro interior Ø 10 cm, se entrega sin platos
pour 3 assiettes Ø 17,5 cm maxi., anneau intérieur Ø 10 cm, livré sans assiettes

	cm	↑ cm	Farbe / Colour	€
33200	22,5 x 16	32		39,00
33202	22,5 x 16	32		39,00
33204	22,5 x 16	32		39,00

für 3 Teller max. Ø 27 cm, innerer Ring Ø 16 cm, Lieferung ohne Teller
for 3 plates max. Ø 27 cm, circle inside Ø 16 cm, delivery without dishes
para 3 platos máx. Ø 27 cm, aro interior Ø 16 cm, se entrega sin platos
pour 3 assiettes Ø 27 cm maxi., anneau intérieur Ø 16 cm, livré sans assiettes

	Ø cm	↑ cm	Farbe / Colour	€
33201	30	54		49,00
33203	30	54		49,00
33205	30	54		49,00

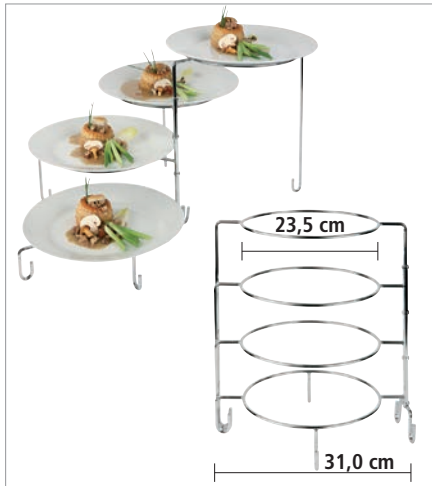
**Serviergestell**

serving stand
soporte platos
présentoir à assiettes



für 4 Teller (max. Ø 31 cm), platzsparend zusammendrehbar, Lieferung ohne Teller
for 4 plates (max. Ø 31 cm), can be pushed together for place saving, without dishes
para 4 platos (max. Ø 31 cm) se puede plegar para ahorrar espacio, se sirve sin platos
pour 4 assiettes (maxi Ø 31 cm), peut se refermer pour réduire l'encombrement, livré sans assiettes

	Ø cm	↑ cm	€
33225	34	37	64,00

**Serviergestell**

serving stand
soporte platos
présentoir à assiettes



für 2 Teller max. Ø 27 cm, innerer Ring Ø 18 cm, Lieferung ohne Teller
for 2 plates max. Ø 27 cm, circle inside Ø 18 cm, without dishes
para 2 platos Ø 27 cm, interior aro Ø 18 cm, se entrega sin platos
pour 2 assiettes maxi Ø 27 cm, cercle Ø int. 18 cm, livré sans assiettes

	cm	↑ cm	€
33214	33 x 23,5	30	33,00

**Serviergestell**

serving stand
soporte platos
présentoir à assiettes



für 3 Teller max. Ø 17 cm, innerer Ring Ø 10,5 cm
for 3 plates max. Ø 17 cm, circle inside Ø 10,5 cm
para 3 platos Ø 17 cm, interior aro Ø 10,5 cm
pour 3 assiettes maxi Ø 17 cm, cercle Ø int. 10,5 cm

	cm	↑ cm	€
33216	22,5 x 16,5	25,5	26,00

**Serviergestell**

serving stand
soporte platos
présentoir à assiettes



für 3 Teller max. Ø 27 cm, innerer Ring Ø 18 cm
for 3 plates max. Ø 27 cm, circle inside Ø 18 cm
para 3 platos Ø 27 cm, interior aro Ø 18 cm
pour 3 assiettes maxi Ø 27 cm, cercle Ø int. 18 cm

	cm	↑ cm	€
33217	33 x 24	43	42,00

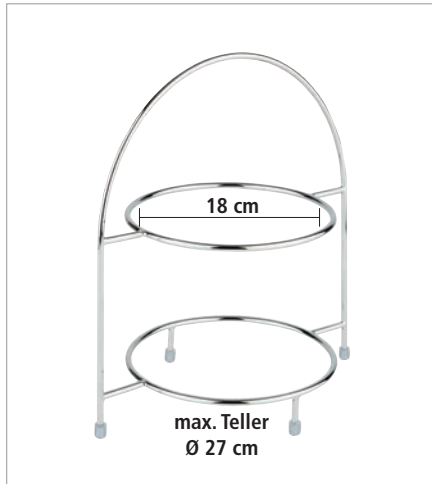
**Serviergestell**

serving stand
soporte platos
présentoir à assiettes



für 2 Teller max. Ø 27 cm, innerer Ring Ø 18 cm
for 2 plates max. Ø 27 cm, circle inside Ø 18 cm
para 2 platos Ø 27 cm, interior aro Ø 18 cm
pour 2 assiettes maxi Ø 27 cm, cercle Ø int. 18 cm

	cm	↑ cm	Farbe / Colour	€
33219	29 x 19,5	30		27,40

**Serviergestell**

serving stand
soporte platos
présentoir à assiettes



für 3 Teller max. Ø 17 cm, innerer Ring Ø 10,5 cm
for 3 plates max. Ø 17 cm, circle inside Ø 10,5 cm
para 3 platos Ø 17 cm, interior aro Ø 10,5 cm
pour 3 assiettes maxi Ø 17 cm, cercle Ø int. 10,5 cm

	cm	↑ cm	Farbe / Colour	€
33215	18,5 x 15,5	26	chrome	21,00
33211	18,5 x 15,5	26	copper	23,00

**Serviergestell**

serving stand
soporte platos
présentoir à assiettes



für 3 Teller max. Ø 27 cm, innerer Ring Ø 18 cm
for 3 plates max. Ø 27 cm, circle inside Ø 18 cm
para 3 platos Ø 27 cm, interior aro Ø 18 cm
pour 3 assiettes maxi Ø 27 cm, cercle Ø int. 18 cm

	cm	↑ cm	Farbe / Colour	€
33220	29 x 19,5	43	chrome	35,00
33212	29 x 19,5	43	copper	37,00

**Etagère**

etagère
frutero
présentoir à fruits



hochglanzpoliert, Edelstahl-Schale herausnehmbar
mirror polished finish, bowl removable
acabado brillante, bandeja inferior suelta
effet brillant, bol inférieur amovible

	Ø cm	↑ cm	€
33235	27,5	32	62,00
33240	32,0	53	97,00

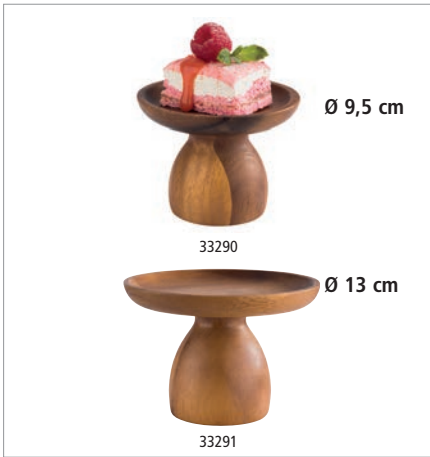

Servier- und Tortenplatte „ACACIA MINI“

cake stand
porta pasteles
présentoir à gâteaux

Akazienholz geölt
acacia wood oiled
madera de acacia aceitada
bois d'acacia huilé



	Ø cm	↑ cm	€
33290	9,5	7	12,00
33291	13,0	9	16,00



Servier- und Tortenplatte „ACACIA“

cake stand
porta pasteles
présentoir à gâteaux

Akazienholz geölt
acacia wood oiled
madera de acacia aceitada
bois d'acacia huilé



	Ø cm	↑ cm	€
33292	24,0	8	39,00
33293	24,0	16	49,00
33294	33,0	8	54,00
33295	33,0	16	74,00
33296	38,5	8	66,00
33297	38,5	16	89,00



Frischhalte- Haube / cover / campana / cloche



	Ø cm	↑ cm	fits to	€
06519	21	17	33292, 33293	24,00
06520	30	22	33294, 33295	29,90
06521	36	27	33296, 33297	56,00

**Serviergestell**

serving stand
expositor
présentoir



3-stufig für quadratische Teller / Platten in 3 verschiedenen Größen:

z.B. 83407 + 83406 + 83405, Lieferung ohne Teller/Platten

3-tier for square dishes / plates in 3 different sizes: e.g. 83407 + 83406 + 83405, delivery without dishes / plates

3 alturas para platos cuadrados fuentes en 3 diferentes medidas p.e. 83407 + 83406 + 83405, se entrega sin platos/ fuentes

3 niveaux pour assiettes ou plats carrés de différentes dimensions, ex. 83407 + 83406 + 83405, livré sans assiettes

	cm	↑ cm	€
33231	37,5 x 37,5	50	87,00

**Etagère „CASUAL“**

etagère
expositor de bombones o bocaditos
présentoir à mignardises



inklusive Edelstahl-Schild, beschriftbar

including sign

placa incluida, sin inscripción

étiquette incluse, sans inscription

	Ø cm	↑ cm	€
34248	31 - 41 - 51	55	109,00
34247	31 - 41	35	66,00

**Etagère „FINESSE“**

etagère
frutero
étagère



vergoldeter Messing-Kugelgriff, einfache Montage

gold plated knob, easy to assemble

botón dorado, fácil de montar

bouton doré, montage facile

	Ø cm	↑ cm	€
33248	48 / 38 / 32	50	95,00
33238	38 / 32	30	58,00

**3-stufige Etagère**

3-tier tray
bandeja con tres alturas
étagère carré 3 hauteurs



Naturschiefer, Akazienholz

natural slate tray, wood akazie

bandeja de pizarra natural, madera de acacia

plateau ardoise naturelle, bois d'acacia

	Ø cm	↑ cm	mm	€
00960	30 / 25 / 20	34	6 - 9	26,00

**2-stufige Etagère**

2 tier tray
bandeja dos alturas
plat carré 2 hauteurs

Naturschiefer

natural slate tray
bandeja de pizarra natural
plateau ardoise naturelle



	Ø cm	↑ cm	* mm	€
00989	25 / 20	24	6 - 9	13,20

**Brezel- oder Wurstständer**

pretzel-/ sausage stand
soporte para embutidos
support à bretzel ou à saucissons

Verkaufsständer Buchen-Holz versiegelt, bestens geeignet für die Präsentation von Brezeln, Würstchen, etc., Fuß Ø 22 cm

beech wood, ideal to present pretzels, sausages, etc.

madera de haya, ideal para presentar fiambres, salchichones etc.

en hêtre, idéal pour bretzels ou saucissons, etc.



	Ø cm	↑ cm	€
79553	28	50	19,00

Hygieneschutz für Brezelständer / hygienic cover / cubierta higiénica antialiento / pare-haleine

	cm	↑ cm	€
11557	20 x 20 x 20	50	21,00
11558	15 x 20 x 15	50	19,00

**Serviergestell, 2-stufig**

servicing stand, 2-tier
soporte platos, 2 alturas
présentoir, 2 hauteurs

3 tlg. Set, 1 Gestell aus Akazienholz, 2 Schieferplatten, zusammenklappbar

3 pcs. set, 1 stand acacia wood, 2 slate tray, foldable

set de 3: 1 soporte madera de acacia, 2 bandeja de pizarra, fácil de plegar

set de 3: 1 présentoir au pour tous les seaux à FRAMES



**zusammenklappbar
foldable**

	cm	↑ cm	€
00958	36,5	34 x 26,5	32,00

**Serviergestell „FLEXIBEL“**

servicing stand
expositor
présentoir

3-stufig „beweglich / drehbar“, platzsparend zerlegbar

3 tier, flexible frame, space saving

3 alturas, marco flexible, ahorra espacio

3 hauteurs, cadre souple, gagne de la place



	cm	↑ cm	€
33243	45,5 x 32	21,5	48,00

Tablett „PURE COLOR“ / tray / bandeja / plateau

	cm	↑ cm	Farbe / Colour	€
83403	35,5 x 18	3		12,00

**Serviergestell „S-PURE“**

serving stand
soporte buffet
support buffet



für 3 Tablett quadratisch 83407 oder 83418

for 3 trays square 83407 or 83418

para 3 bandejas cuadradas 83407 o 83418

pour 3 plats carrés 83407 ou 83418

	cm	↑ cm	€
33226	29 x 17	41	42,00

**Serviergestell „M-PURE“**

serving stand
soporte buffet
support buffet



für 3 Tablett quadratisch 83406 oder 83407

for 3 trays square 83406 or 83407

para 3 bandejas cuadradas 83406 o 83407

pour 3 plats carrés 83406 o 83407

	cm	↑ cm	€
33227	33 x 21	44	50,00

**Serviergestell „L-PURE“**

serving stand
soporte buffet
support buffet



für 3 Tablett rechteckig 83417

for 3 trays rectangular 83417

para 3 bandejas rectangulares 83417

pour 3 plats rectangulaires 83417

	cm	↑ cm	€
33228	37 x 21	44	55,00

**GN Serviergestell „XL-PURE“**

GN serving stand
GN soporte buffet
GN support buffet



passend für Tablett GN 1/1, GN 1/2, GN 1/3, GN 2/4

suitable for tray GN 1/1, GN 1/2, GN 1/3, GN 2/4

aptas para bandejas GN 1/1, GN 1/2, GN 1/3, GN 2/4

convient pour les plats GN 1/1, GN 1/2, GN 1/3, GN 2/4

	cm	↑ cm	€
33222	63 x 27	44,5	72,00



Buffetgestell „FLOAT SMALL“

buffet stand
soporte buffet
support buffet



Metall verchromt, für 3 Schalen Nr. 83916, 83917
metal chrome plated, for 3 bowls no. 83916, 83917
metal cromado, para 3 cuencos N° 83916, 83917
métal chromé, pour 3 coupelles 83916, 83917

	cm	↑ cm	€
33241	55,5 x 19	15,5	37,00

Schale „FLOAT“ / bowl / cuenco / bol

	cm	↑ cm	Farbe / Colour	€
83916	19 x 19	9,5	White	14,20
83917	19 x 19	9,5	Black	14,20



Buffetgestell „FLOAT BIG“

buffet stand
soporte buffet
support buffet



Metall verchromt, für 3 Schalen Nr. 83914, 83915, für 1 Schale Nr. 83918, 83919
metal chrome plated, for 3 bowls no. 83914, 83915, for 1 bowl no. 83918, 83919
metal cromado, para 3 cuencos N° 83914, 83915, para 1 cuenco N° 83918, 83919
métal chromé, pour 3 coupelles 83914, 83915 ou 1 bol 83918, 83919

	cm	↑ cm	€
33242	39 x 39	17	58,00

Schale „FLOAT“ / bowl / cuenco / bol

	cm	↑ cm	Farbe / Colour	€
83914	12,5 x 12,5	6,0	White	6,00
83918	25,0 x 25,0	12,0	White	26,00
83915	12,5 x 12,5	6,0	Black	6,00
83919	25,0 x 25,0	12,0	Black	26,00

Buffetleiter GN



Buffetleiter „LITTLE GN 1/3“
buffet ladder
dispensador en escalera
présentoir buffet en escalier



4-teilig: 1 Leiter-Gestell, 3 GN 1/3 Rahmen
4 pcs.: 1 ladder, 3 single rings GN 1/3
4 pz: 1 soporte escalera, 3 aros sencillos GN 1/3
4 pc: 1 support escalier, 3 cercles simples GN 1/3

	cm	↑ cm	fits to	€
11526	31,5 x 32	48	baskets / pans GN 1/3	68,00



Buffetleiter „LITTLE GN 1/2“
buffet ladder
dispensador en escalera
présentoir buffet en escalier



4-teilig: 1 Leiter-Gestell, 3 GN 1/2 Rahmen
4 pcs.: 1 ladder, 3 single rings GN 1/2
4 pz: 1 soporte escalera, 3 aros sencillos GN 1/2
4 pc: 1 support escalier, 3 cercles simples GN 1/2

	cm	↑ cm	fits to	€
11527	31,5 x 41,5	48	baskets / pans GN 1/2	82,00

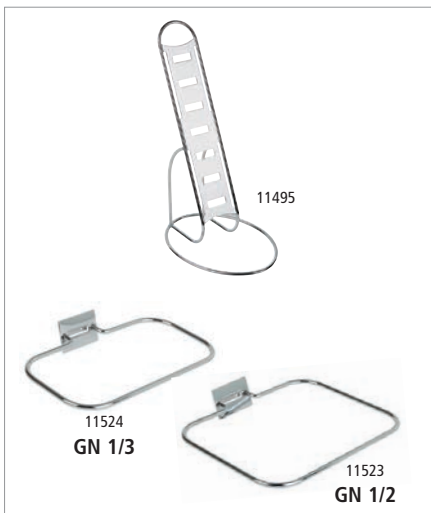

Einzelteile / spare parts / piezas sueltas / pièces détachées

Leitergestell / frame / marco solo en escalera / échelle support

11495	€	33,00
-------	---	-------

Einzelring GN 1/3 / single ring GN 1/3 / aro sencillo GN 1/3 / cercle simple GN 1/3

11524	€	13,50
-------	---	-------

Einzelring GN 1/2 / single ring GN 1/2 / aro sencillo GN 1/2 / cercle simple GN 1/2

11523	€	18,00
-------	---	-------



Buffetleiter „BIG GN 1/2“
buffet ladder
dispensador en escalera
présentoir buffet en escalier

5-teilig: 1 Leiter-Gestell, 4 GN 1/2 Rahmen
5 pcs.: 1 ladder, 4 single rings GN 1/2
5 pz: 1 soporte escalera, 4 aros sencillos GN 1/2
5 pc: 1 support escalier, 4 cercles simples GN 1/2

METALL VERCHROMT

	cm	↑ cm	fits to	€
11528	31,5 x 56	66	baskets / pans GN 1/2	132,00



Buffetleiter „BIG GN 1/1“
buffet ladder
dispensador en escalera
présentoir buffet en escalier

4-teilig: 1 Leiter-Gestell, 3 GN 1/1 Rahmen
4 pcs.: 1 ladder, 3 single rings GN 1/1
4 pz: 1 soporte escalera, 3 aros sencillos GN 1/1
4 pc: 1 support escalier, 3 cercles simples GN 1/1

METALL VERCHROMT

	cm	↑ cm	fits to	€
11529	52 x 59	66	baskets / pans GN 1/1	132,00

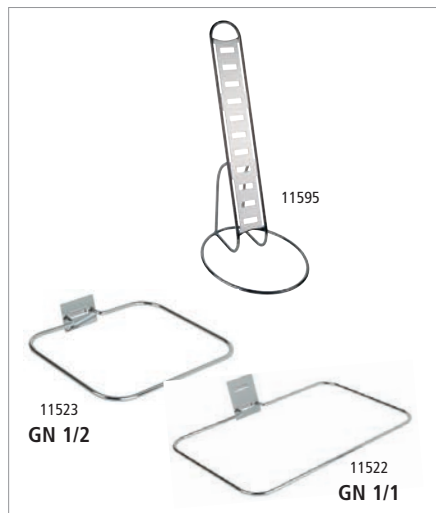

Einzelteile / spare parts / piezas sueltas / pièces détachées

Leitergestell / frame / marco solo en escalera / échelle support	€
11595	64,00
Einzelring GN 1/2 / single ring GN 1/2 / aro sencillo GN 1/2 / cercle simple GN 1/2	€
11523	18,00
Einzelring GN 1/1 / single ring GN 1/1 / aro sencillo GN 1/1 / cercle simple GN 1/1	€
11522	25,00



jede Schale /
each bowl
ca. 2,5 ltr.

Buffetleiter „BIG“

buffet ladder
dispensador en escalera
présentoir buffet en escalier



12-teiliges Set: 4 Glasschalen Ø 23 cm 2,5 Liter, 4 klappbare Schutzdeckel mit Beschriftungsfenster, 1 Leiter, 1 Doppelring, 2 Einzelringe, einfach und individuell zusammensetzbar

12 pcs. set: 4 glass bowls Ø 23 cm 2.5 litres, 4 hinged covers with card for inscription, 1 ladder, 1 double ring, 2 single rings, easy to fix and individual to use

set de 12: 4 boles vidro Ø 23 cm 2,5 l, 4 tapas abatibles con ventana para etiqueta, 1 soporte escalera, 1 aro doble, 2 aros sencillos, fácil de montar, posible usar individualmente

set de 12: 4 bols verre Ø 23 cm 2,5 l, 4 couvercles à charnière et fenêtre p/ étiquette, 1 support escalier, 1 cercle double, 2 cercles simples, montage facile, utilisable individuellement

	cm	↑ cm	€
11598	39 x 31	66	172,00



jede Schale /
each bowl
ca. 2,5 ltr.

Buffetleiter „BIG“

buffet ladder
dispensador en escalera
Présentoir buffet en escalier



11-teiliges Set: 6 Glasschalen Ø 23 cm 2,5 Liter, 1 Leiter, 2 Doppelringe, 2 Einzelringe, einfach und individuell zusammensetzbar

11 pcs. set: 6 glass bowls Ø 23 cm 2.5 litres, 1 ladder, 2 double rings, 2 single rings, easy and individual to use

set de 11: 6 boles vidro Ø 23 cm 2,5 l, 1 soporte escalera, 2 aros dobles, 2 aros sencillos, fácil montar, se puede usar individualmente

set de 11: 6 bols verre Ø 23 cm 2,5 l, 1 support escalier, 2 cercles double, 2 cercles simples, montage facile, utilisable individuellement

	cm	↑ cm	€
11599	39 x 31	66	150,00

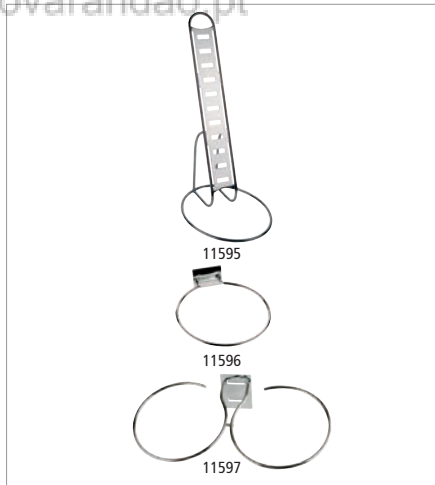

Einzelteile / spare parts / piezas sueltas / pièces détachées

Leitergestell / frame / marco solo en escalera / échelle support

11595	€ 64,00
-------	---------

Einzelring / single ring / aro sencillo / cercle simple

11596	€ 13,00
-------	---------

Doppelring / double ring / aro doble / cercle double

11597	€ 23,50
-------	---------



2,5 ltr.

Schale

bowl
cuenco
bol



	Ø cm	↑ cm	ltr.	€
11875	23	10,5	2,5	4,20



Schutzdeckel mit Löffelaussparung

cover
tapa
couvercle



	Ø cm	€
11878	23,5	11,40



jede Schale /
each bowl
ca. 0,5 ltr.

Buffetleiter „LITTLE“

buffet ladder
dispensador en escalera
présentoir buffet en escalier



12-teiliges Set: 4 Glasschalen Ø 14 cm 0,5 Liter, 4 klappbare Schutzdeckel mit Beschriftungsfenster, 1 Leiter, 1 Doppelring, 2 Einzelringe, einfach und individuell zusammensetzbar

12 pcs. set: 4 glass bowls Ø 14 cm 0.5 litres, 4 hinged covers with card for inscription, 1 ladder, 1 double ring, 2 single rings, easy and individual to use

set de 12: 4 boles vidro Ø 14 cm 0,5 l, 4 tapas abatíveis com ventana para etiqueta, 1 soporte escalera, 1 aro doble, 2 aros sencillos, fácil montaje, se puede usar individualmente

set de 12: 4 bols verre Ø 14 cm 0,5 l, 4 couvercles à charnière et fenêtre p/ étiquette, 1 support escalier, 1 cercle double, 2 cercles simples, montage facile, utilisable individuellement

	cm	↑ cm	€
11498	30 x 30	48	109,00



jede Schale /
each bowl
ca. 0,5 ltr.

Buffetleiter „LITTLE“

buffet ladder
dispensador en escalera
Présentoir buffet en escalier



11-teiliges Set: 6 Glasschalen Ø 14 cm 0,5 Liter, 1 Leiter, 2 Doppelringe, 2 Einzelringe, einfach und individuell zusammensetzbar

11 pcs. set: 6 glass bowls Ø 14 cm 0.5 litres, 1 ladder, 2 double rings, 2 single rings, easy and individual to use

set de 11: 6 boles vidro Ø 14 cm 0,5 l, 1 soporte escalera, 2 aros dobles, 2 aros sencillos, fácil montaje, se puede usar individualmente

set de 11: 6 bols verre Ø 14 cm 0,5 l, 1 support escalier, 1 cercle double, 2 cercles simples, montage facile, utilisable individuellement

	cm	↑ cm	€
11499	30 x 30	48	94,00

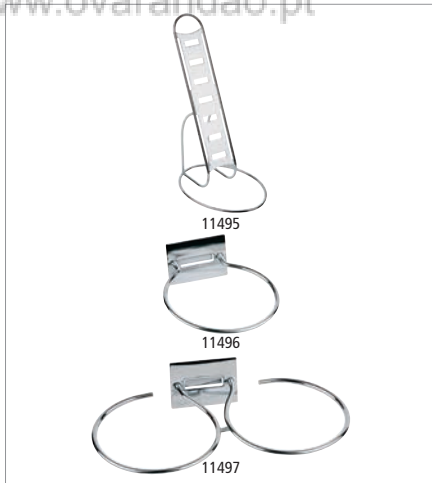

Einzelteile / spare parts / piezas sueltas / pièces détachées

Leitergestell / frame / marco solo en escalera / échelle support

	€
11495	33,00

Einzelring / single ring / aro sencillo / cercle simple

	€
11496	9,00

Doppelring / double ring / aro sencillo / cercle double

	€
11497	16,00



0,5 ltr.

Schale

bowl
cuenco
bol



	Ø cm	↑ cm	ltr.	pcs.	€ / pc.
11865	14	6,5	0,5	6	2,20



Schutzdeckel mit Löffelaussparung

cover
tapa
couvercle



	Ø cm	€
11868	14,5	10,40



Buffetgestell „SUNDAY“

buffet stand
expositor bufé
présentoir buffet



7-teiliges Set: 3 Glasschalen Ø 23 cm (2,5 Liter), 3 klappbare Schutzdeckel, 1 Gestell

7 pcs. set: 3 glass bowls Ø 23 cm (2,5 litres), 3 hinged covers, 1 stand

set de 7: 3 boles vidro Ø 23 cm (2,5 l), 3 tapas con bisagra, 1 soporte

set de 7: 3 bols verre Ø 23 cm (2,5 l), 3 couvercles à charnière, 1 support

	cm	↑ cm	€
11795	61 x 24	35	119,00



Buffetständer „BIG“

buffet stand
expositor de buffet
présentoir buffet



7-teiliges Set: 3 Glasschalen Ø 23 cm 2,5 Liter, 3 klappbare Schutzdeckel, 1 Ständer

7 pcs. set: 3 glass bowls Ø 23 cm 2.5 litres, 3 hinged covers, 1 stand

set de 7: 3 boles vidro Ø 23 cm, 2,5 l, 3 tapas con bisagra, 1 soporte

set de 7: 3 bols verre Ø 23 cm 2,5 l, 3 couvercles à charnière, 1 support

	cm	↑ cm	€
11892	50 x 50	18	114,00



Buffetständer „LITTLE“

buffet stand
expositor de buffet
présentoir buffet



7-teiliges Set: 3 Glasschalen Ø 14 cm 0,5 Liter, 3 klappbare Schutzdeckel, 1 Ständer

7 pcs. set: 3 glass bowls Ø 14 cm 0,5 l, 3 hinged covers, 1 stand

set de 7: 3 boles vidro Ø 14 cm, 0,5 l, 3 tapas con bisagra, 1 soporte

set de 7: 3 bols verre Ø 14 cm 0,5 l, 3 couvercles à charnière, 1 support

	cm	↑ cm	€
11893	30 x 30	14	84,00



Besteckständer „TRIPLE TOWER“

cutlery basket
cesta para cubiertos
égouttoir à couverts



4-teiliges Set: 1 Gestell + 3 Köcher

4 pcs. set: 1 frame + 3 baskets

set de 4: 1 estructura + 3 cubiertos

set de 4: 1 structure + 3 corbeilles

	cm	↑ cm	Farbe / Colour	€
11466	18 x 26	43	White	79,00
11467	18 x 26	43	Black	79,00



variable Nutzungsmöglichkeiten
variable usage possibilities



Vitrine / Thekenaufsatz

showcase
vitrina de mostrador
vitrine de comptoir



rutschfest, aus einem Teil gefertigt
antislip, monoblock produced
plástico transparente, fabricado en 1 pieza
transparente, plastique monoblock (injecté)

	cm	↑ cm	€
11888	63,5 x 25	25	82,00



Snackpresenter

snackpresenter
dispensador de bocadillos
présentoir à sandwiches



mit Safrille und Griffmulde, passend für Vitrine 11888
with recessed grip, suitable for showcase 11888
asa moldeada, apto para la vitrina 11888
anse moulée, apte pour vitrine 11888

	cm	↑ cm	€
11887	29 x 19	6,5	19,40
11889	60 x 19	7,5	24,00

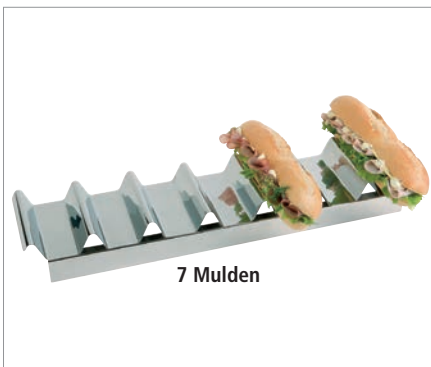

Snackpresenter

snackpresenter
dispensador de bocadillos
présentoir à sandwiches



hochglanzpoliert, mit Griffmulde, für 7 Baguettes
mirror polished finish, with recessed grip, for 7 baguettes
inox pulido brillante, ideal para hasta 7 bocadillos
inox poli brillant, parfait jusque maxi 7 sandwiches

	cm	↑ cm	€
11891	47,5 x 10,5	6	25,00

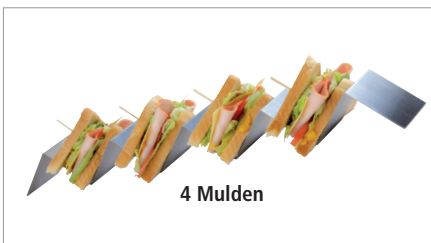

Snackpresenter

snackpresenter
dispensador de bocadillos
présentoir à sandwiches



	cm	↑ cm	€
11969	56 x 8	5,5	12,00

Brotstation

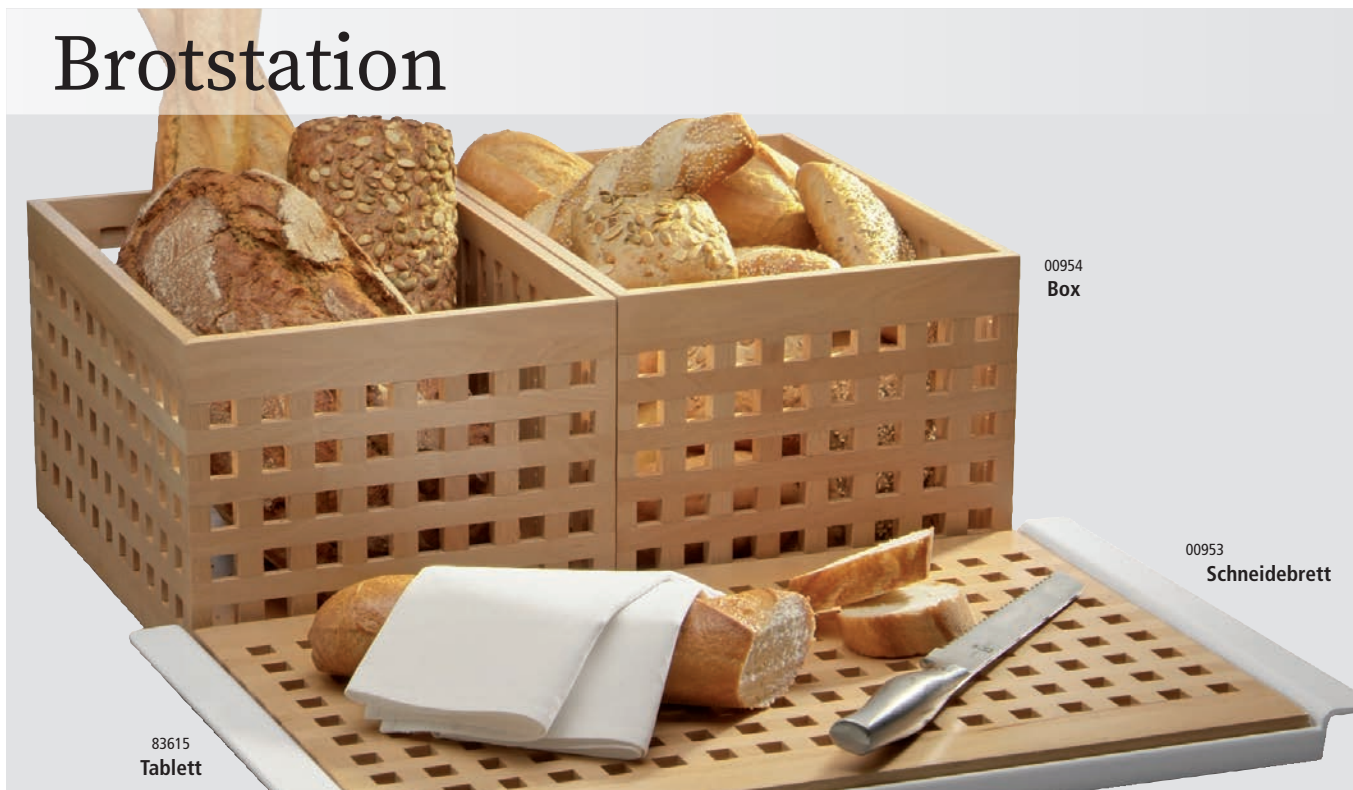

00954
Box

00953
Schneidebrett

83615
Tablett



Tablett „BROTSTATION“

tray
bandeja
plateau



Antirutsch-Füßchen
non-slip feet
pies antideslizantes
pieds antiglisse

	cm	↑ cm	€
83615	59,5 x 35,5	3,5	37,00

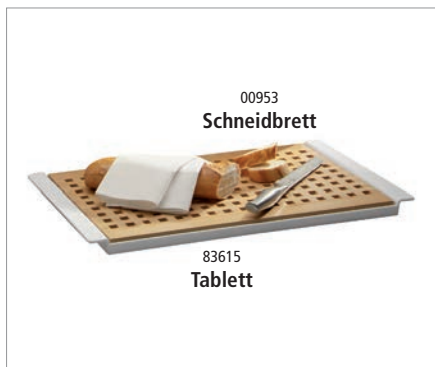

00953
Schneidebrett

83615
Tablett

Brotschneidebrett „BROTSTATION“

cutting board
tabla de corte
planche à découper



Buchen-Holz
beech
haya
hêtre

	cm	↑ cm	€
00953	52 x 34	2	33,00

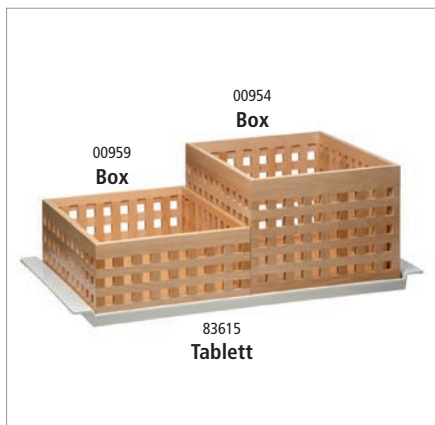

00954
Box

00959
Box

83615
Tablett

Box „BROTSTATION“

box
caja de pan para el buffet
boîte à pain pour le buffet



Buchen-Holz
beech
haya
hêtre

	cm	↑ cm	€
00959	34 x 26	12,5	50,00
00954	34 x 26	20,0	56,00

**Buffetbrett „PROFI“**

board
tabla para el buffet
planche découper buffet



	cm	↑ cm	€
00806	58 x 37,5	4	89,00

**Brotschneidebrett „LETTER“**

cutting board
tabla para cortar
planche à découper



	cm	↑ cm	€
00886	48 x 34	3,5	32,00

**Brotschneidebrett „AKAZIA“**

cutting board
tabla para cortar
planche à découper



	cm	↑ cm	GN	€
00883	47,5 x 32,0	2		25,80
00884	53,0 x 32,5	2	1/1	26,40
00885	60,0 x 40,0	2		32,00



praktisches Krümelfach
practical crump shelf

**Brotschneidebrett „RUBBERWOOD“**

cutting board
tabla para cortar
planche à découper



	cm	↑ cm	GN	€
00955	47,5 x 32,0	2		24,00
00956	53,0 x 32,5	2	1/1	25,00
00957	60,0 x 40,0	2		29,00

**Brotschneidebrett, 2-tlg.**

cutting board, 2 pcs.
tabla para cortar, set de 2
planche à découper, set de 2



2-tlg. Set, GN 1/1 Behälter, 20 mm tief, dient als Krümelfach

2 pcs. set, GN 1/1 pan 20 mm, bread crump shelf

set de 2: tabla de corte + bandeja inox GN 1/1 alt 20 mm (sirve para recoger las migas)

set de 2: planche à découper bois + plateau inox GN 1/1 Ht 20 mm (sert de ramassemies)

	cm	GN	€
00951	53 x 32,5	1/1	33,00

einzelnes Brett / separate board / tabla por separado / planche seule

	cm	GN	€
00952	53 x 32,5	1/1	19,00



12050
4,5 ltr.

12051
4,5 ltr.

Cerealienspender

cereal dispenser
dispensador de cereales
distributeur de céréales



Behälter herausnehmbar, portionieren durch einfaches Drehen
removable canister, easy to use, rotate the button to get the muesli
contenedor movable, fácil de usar, se gira el pomo para servir los cereales
réceptif amovible, usage facile en tournant le bouton

	cm	↑ cm	ltr.	Farbe / Colour	€
12050	24 x 17,5	49,5	4,5	White	59,00
12051	24 x 17,5	49,5	4,5	Black	59,00



12054
2 x 4,5 ltr.

12055
2 x 4,5 ltr.

Cerealienspender „DUO“

cereal dispenser
dispensador de cereales
distributeur de céréales



Behälter herausnehmbar, portionieren durch einfaches Drehen
removable canister, easy to use, rotate the button to get the muesli
contenedor movable, fácil de usar, se gira el pomo para servir los cereales
réceptif amovible, usage facile en tournant le bouton

	cm	↑ cm	ltr.	Farbe / Colour	€
12054	24 x 37,5	49,5	2 x 4,5	White	109,00
12055	24 x 37,5	49,5	2 x 4,5	Black	109,00



**Buffetständer „GOOD MORNING“**

buffet stand
expositor de buffet
présentoir de buffet

HOLZ
WOODGLAS
GLASS

4-teiliges Set: Holzständer inkl. 3 Gläser mit luftdichtem Klappdeckel

4 pcs. set: wood stand included 3 glass with airtight cover

set de 4: soporte, 3 boles de cristal, cierre hermético

set de 4: présentoir, 3 bols en verre, fermeture hermétique

	cm	Farbe / Colour	€
13965	43 x 17		82,00
14965	43 x 17		82,00

Glas mit luftdichtem Klappdeckel / glass with airtight cover / cristal, cierre hermético / verre, fermeture hermétique

	cm	↑ cm	ltr.	€
82328	12 x 12	22	2	6,20

**Cerealienspender „FRESH & EASY“**

cereal dispenser
dispensador de cereales
distributeur de céréales

SAN
KUNSTSTOFFSILIKON
SILICONGUSS
ZINKEDELSTAHL
STAINLESS
INOX

Behälter herausnehmbar, „Feierabend-Deckel“ für das aromatische Lagern, portionieren durch einfaches Drehen

removable canister, special lid to keep the cereals fresh, easy to use, rotate the button to get the muesli

contenedor movable, tapa especial para mantener los cereales frescos,

fácil de usar, se gira el pomo para servir los cereales

réipient amovible, couvercle spécial pour conserver les céréales, usage facile en tournant le bouton

	cm	↑ cm	ltr.	€
11805	22 x 17,5	52	4,5	66,00

**Cerealienspender Duo „FRESH & EASY“**

cereal dispenser
dispensador de cereales
distributeur de céréales

SAN
KUNSTSTOFFSILIKON
SILICONGUSS
EISENEDELSTAHL
STAINLESS
INOX

Behälter herausnehmbar, „Feierabend-Deckel“ für das aromatische Lagern, portionieren durch einfaches Drehen

removable canister, special lid to keep the cereals fresh, easy to use, rotate the button to get the muesli

contenedor movable, tapa especial para mantener los cereales frescos, fácil de usar, se gira el pomo

para servir los cereales

réipient amovible, couvercle spécial pour conserver les céréales, usage facile en tournant le bouton

	cm	↑ cm	ltr.	€
11807	22 x 35	52	2 x 4,5	122,00

Kunststoffbehälter / canister / contenedor / réipient

	Ø cm	ltr.	€
11808	24	4,5	24,00

**Cerealienspender „CLASSIC“**

cereal dispenser
dispensador de cereales
distributeur de céréales

SILIKON
SILICONPC
POLYCARB.EDELSTAHL
STAINLESS
INOX
18/8

Portionieren durch einfaches Drehen, Behälter herausnehmbar

canister removable

contenedor movable

réipient amovible

	cm	↑ cm	ltr.	€
11833	35 x 26,5	68	8	184,00



Cerealienspender „CLASSIC DUO“

cereal dispenser
dispensador de cereales
distributeur de céréales



Portionieren durch einfaches Drehen, Behälter herausnehmbar

canister removable
contenedor movable
récipient amovible

	cm	↑ cm	ltr.	€
11834	35 x 50	68	2 x 8	334,00



Cerealienspender „BRIDGE“

cereal dispenser
dispensador de cereales
distributeur de céréales



Behälter herausnehmbar, „Feierabend-Deckel“ für das aromadichte Lagern, portionieren durch einfaches Drehen

removable canister, special lid to keep the cereals fresh, easy to use, rotate the button to get the muesli

contenedor movable, tapa especial para mantener los cereales frescos, fácil de usar, se gira el pomo para servir los cereales

récipient amovible, couvercle spécial pour conserver les céréales, usage facile en tournant le bouton

	cm	↑ cm	ltr.	Farbe / Colour	€
13987	21 x 20	55,5	4,5	Ahorn	102,00
14987	21 x 20	55,5	4,5	Wenge	102,00



Cerealienspender „ROTATION“

cereal dispenser
dispensador de cereales
distributeur de céréales



matt poliert, drehbarer massiver Ständer, Behälter herausnehmbar, inkl. Frischhaltedeckel

satín polished finish, rotating food, canister removable, incl. airtight covers

pulido acabado satinado, giratorio, incluye tapas herméticas

mat satiné, rotatif, inclut couvercles hermétiques

	Ø cm	↑ cm	ltr.	€
11970	38	54	3 x 4,5	310,00

Kunststoffbehälter / canister / contenedor / récipient

11808				24,00
-------	--	--	--	-------



Cerealienspender „ROTATION“

cereal dispenser
dispensador de cereales
distributeur de céréales



Buchen-Holz versiegelt, drehbarer massiver Ständer, Behälter herausnehmbar, inkl. Frischhaltedeckel

wood beech covered waterproof, rotating food, canister removable, incl. airtight cover

tapa en madera de haya resistente al agua, pie giratorio, recipiente removable, incluye tapa hermética

couvercle en hêtre traitée contre l'humidité, pied rotatif, récipients démontables, inclut couvercles hermétiques

	Ø cm	↑ cm	ltr.	€
11975	38	54	3 x 4,5	314,00



Cerealien-Bar

cereal-bar
barra para dispensador de cereales
bar à céréales



5-teiliges Set, mit Ständerhöhe 4 oder 8 cm: 1 Ständer aus Acryl gefrostet und rutschfest + 2 Karaffen mit schwenkbarem Edelstahl-Deckel + 2 luftdichte Frischhaltedeckel

5 pcs. set, with stand heights 4 or 8 cm: 1 stand acryl frosted and anti-slip + 2 pitchers with stainless steel flap lid + 2 airtight covers

set de 5: stands a diferentes alturas, 4 u 8 cm: 1 stand acryl + 2 jarras con tapa de solapa de acero inoxidable + 2 tapas herméticas adicionales

set de 5: supports à différentes hauteurs: 4 ou 8 cm - 1 support acrylique satiné antiglisse + 2 pichets à céréales avec couvercle à charnière inox + 2 couvercles hermétiques

	cm	↑ cm	ltr.	€
11971	26 x 17	28,5	2 x 1,5	64,00
11972	26 x 17	32,5	2 x 1,5	89,00



ideal für Stufenpräsentation
best for staged presentations



Cerealien-Bar

cereal-bar
barra para dispensador de cereales
bar à céréales



7-teiliges Set, mit Ständerhöhe 4 oder 8 cm: 1 Ständer aus Acryl gefrostet und rutschfest + 3 Karaffen mit schwenkbarem Edelstahl-Deckel + 3 luftdichte Frischhaltedeckel

7 pcs. set, with stand heights 4 or 8 cm: 1 stand acryl frosted and anti-slip + 3 pitchers with stainless steel flap lid + 3 airtight covers

set de 7: con stands a diferentes alturas, 4 u 8 cm: 1 stand acryl + 3 jarras con tapa de solapa de acero inoxidable + 3 tapas herméticas adicionales

set de 7: supports à différentes hauteurs: 4 ou 8 cm - 1 support acrylique satiné antiglisse + 3 pichets à céréales avec couvercle à charnière inox + 3 couvercles hermétiques

	cm	↑ cm	ltr.	€
11973	38 x 17	28,5	3 x 1,5	89,00
11974	38 x 17	32,5	3 x 1,5	114,00



ideal für Stufenpräsentation
best for staged presentations



Cerealienkaraffe

cereal pitcher
jarra de cereales
pichet à céréales



schwenkbarer Edelstahl-Deckel, inkl. luftdichtem Frischhaltedeckel

stainless steel flap lid, incl. 1 airtight cover

tapa de solapa de acero inoxidable, incluye otra tapa hermética

couvercle à charnière inox + couvercle hermétique

	Ø cm	↑ cm	ltr.	€
10778	10	28	1,5	21,00

Frishhaltedeckel / conservation lid / tapa de conservación / couvercle

	€
10668	2,80

SERVICE TOWER



11422

11433

Service Tower

service tower
service tower
tour de service



Präsentations- und Spendersystem, bei minimalen Platzbedarf, optimale Wertschöpfung, zum Beispiel im Bereich der Besteckausgabe, Kaffeestationen, Speiseausgaben, Verkaufstheken, etc., Rückwand aus dunklem Holz oder Acryl gefrostet

Presentation and dispenser system, the products find their best creation of value at minimal need of space, for example in the range of coffeestations, food service, counters etc., backplane made of dark wood or acrylic frosted

sistema de presentación y dispensador, con el mínimo espacio conseguirá una excelente presentación de sus productos, por ejemplo en la zona del café, comidas, etc., trasera de madera oscura o de acrílico opaco mate

système de présentation et distribution, très élégant dans un espace minimum, idéal pour la zone café, coin repas, etc., paroi en bois foncé ou en acrylique mat

	cm	↑ cm	Farbe / Colour		€
11431	26 x 18	43	■	2x Schütte, tief + 1x Schütte, flach 2 deep ones + 1 flat one 2 rampas hondas + 1 plana	94,00
11432	26 x 18	43	■	3x Schütte, tief / 3 bowls, deep ones 3 rampas hondas / 3 rampas profundes	94,00
11422	26 x 18	57,5	■	4x Schütte, tief / 4 bowls, deep ones 4 rampas hondas / 4 rampas profundes	114,00

	cm	↑ cm	Farbe / Colour		€
11433	26 x 18	43	■	2x Schütte, tief + 1x Schütte, flach / 2 deep ones + 1 flat one / 2 rampas hondas + 1 plana / 2 rampas profundes + 1 plate	94,00
11434	26 x 18	43	■	3x Schütte, tief / 3 bowls, deep ones 3 rampas hondas / 3 rampas profundes	94,00
11424	26 x 18	57,5	■	4x Schütte, tief / 4 bowls, deep ones 4 rampas hondas / 4 rampas profundes	114,00

Basisfuss / base / pie de la base / pied de la base

	€
11435	41,00

Rückwand Holz / backplane made of wood / trasera de madera / arrière bois

	cm		€
11436	44,5 x 24	für 3 Schütten	33,50
11426	60,0 x 24	für 4 Schütten	47,50

Rückwand Acryl / backplane made of acrylic / trasera acrílica / arrière acrylique

	cm		€
11437	44,5 x 24	für 3 Schütten	33,50
11427	60,0 x 24	für 4 Schütten	47,50

Schütte, tief / bowl, deep / rampa, honda / rampe profonde

	cm	↑ cm	€
11438	22 x 14	7 / 5	6,30

Schütte, flach / bowl / rampa plana / rample plate

	cm	↑ cm	€
11439	22 x 13	3 / 1	6,30



11438

11439

MULTI RACK



Multi Rack

multi rack
dispensador en escalera
support multiple



2-stufig, 3-teilig: 1 Gestell matt poliert + 2 Schütten aus transparent gefrostedem Kunststoff, je ca. 1 Liter

2-tier, 3 pcs. set: 1 frame satin polished finish + 2 bowls frosted plastic, approx. 1 liter

2 alturas - set de 3: 1 soporte inox mate satinado + 2 bols plástico glaseado, aprox. 1 litro

2 niveaux - set de 3: 1 support satiné + 2 bols plastique mat, approx. 1 litre

	cm	↑ cm	€
11442	19 x 24	28	36,60



Multi Rack

multi rack
dispensador en escalera
support multiple



3-stufig, 4-teilig: 1 Gestell matt poliert + 3 Schütten aus transparent gefrostedem Kunststoff, je ca. 1 Liter

3-tier, 4 pcs. set: 1 frame satin polished finish, + 3 bowls frosted plastic, approx. 1 liter

3 alturas, set de 4: 1 estructura inox satinado, + 3 bols de plástico glaseado, aprox. 1 litro

3 niveaux - set de 4: 1 structure inox poli satin, + 3 bols plastique mat, approx. 1 litre

	cm	↑ cm	€
11444	19 x 24	41	42,90



Multi Rack

multi rack
dispensador en escalera
support multiple



3-stufig, 4-teilig: 1 Gestell matt poliert + 1 Schütte aus transparent gefrostedem Kunststoff, ca. 1 Liter + 2 Rutschen aus transparent gefrostedem Kunststoff

3-tier, 4 pcs. set: 1 frame satin polished finish + 1 bowl frosted plastic, approx. 1 liter + 2 slides frosted plastic

3 alturas, set de 4: 1 soporte inox satinado + 1 bol de plástico glaseado, aprox. 1 litro + 2 bols con „tobogán“ en plástico glaseado

3 niveaux - set de 4: 1 structure inox poli satin + 1 bol plastique mat approx. 1 litre + 2 bols avec „toboggan“

	cm	↑ cm	€
11449	19 x 24	41	42,90



Multi Rack

multi rack
dispensador en escalera
support multiple



4-stufig, 5-teilig: 1 Gestell matt poliert + 4 Schütten aus transparent gefrostedem Kunststoff, je ca. 1 Liter

4-tier, 5 pcs. set: 1 frame satin polished finish + 4 bowls frosted plastic, approx. 1 liter

4 alturas, set de 5: 1 estructura inox satinado + 4 bols de plástico glaseado, aprox. 1 litro

4 niveaux - set de 5: 1 structure inox poli satin, 4 bols plastique mat, approx. 1 litre

	cm	↑ cm	€
11446	19 x 31	53	54,00



Multi Rack
multi rack
dispensador en escalera
support multiple



4-stufig, 5-teilig: 1 Gestell matt poliert + 3 Schütten aus transparent gefrostetem Kunststoff, je ca. 1 Liter + 1 Rutsche aus transparent gefrostetem Kunststoff

4-tier, 5 pcs. set: 1 frame satin polished finish + 3 bowls frosted plastic, approx. 1 liter + 1 slide frosted plastic

4 alturas, set de 5 piezas: 1 estructura inox satinado + 3 bols de plástico glaseado, aprox. 1 litro + 1 bol con „tobogán“ de plástico efecto glaseado

4 niveaux - set de 5 éléments: 1 structure inox poli satin + 3 bols plastique mat approx. 1 litre + 1 bol avec „toboggan“

	cm	↑ cm	€
11451	19 x 31	53	54,00



Schütte

Ergänzung für alle Multi-Racks
supplement for all multi racks
suplemento para todos los dispensadores
compléments pour support Multi-Rack



	€
11455 Schütte / canister / bol / bol	6,50



Rutsche

Ergänzung für alle Multi-Racks
supplement for all multi racks
suplemento para todos los dispensadores
compléments pour support Multi-Rack



	€
11456 Rutsche / slide / tobogan / toboggan	6,50

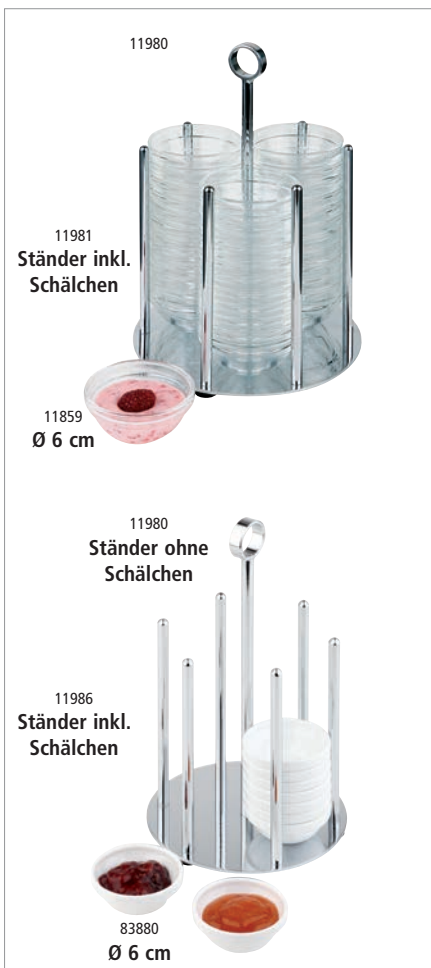

11981
Ständer inkl. Schälchen

11859
Ø 6 cm

11980
Ständer ohne Schälchen

11986
Ständer inkl. Schälchen

83880
Ø 6 cm

Schälchenspender „MINI“
bowl holder
rack dispensador para bols
porte-bols



geeignet für Schalen Ø 6 cm, bestückbar mit bis zu 36 Schalen
for bowls Ø 6 cm, suitable for 36 bowls
para bols de Ø 6 cm, apto para 36 bols
pour bols de Ø 6 cm, maxi 36 bols

	Ø cm	↑ cm	€	
11981	14	25,5	Ständer inkl. 36 Glasschalen, Ø 6 cm / frame with 36 bowls, Ø 6 cm soporte con 36 bols, Ø 6 cm / support livré avec 36 bols en verre Ø 6 cm	91,00
11986	14	25,5	Ständer inkl. 36 Melaminschalen, Ø 6 cm / frame with 36 melamine bowls, Ø 6 cm soporte con 36 bols de melamina Ø 6 cm / support avec 36 bols en mélamine Ø 6 cm	84,00

Schälchenspender „MINI“ / bowl holder / rack dispensador para bols / porte-bols

	Ø cm	↑ cm	€	
11980	14	25,5	Ständer ohne Schalen / frame without bowls soporte sin bols / support sans bols	45,00

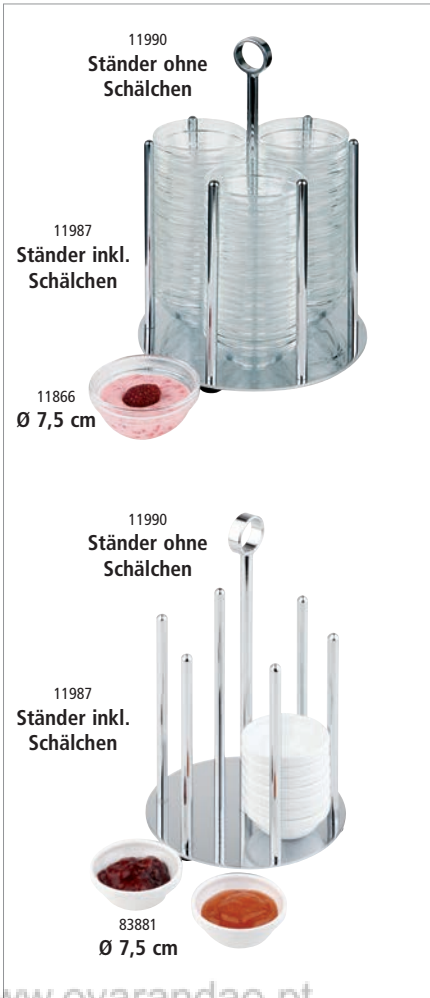

Schälchenspender „MEDIUM“

bowl holder
rack dispensador para bols
porte-bols



geeignet für Schalen Ø 7,5 cm, bestückbar mit bis zu 36 Schalen
for bowls Ø 7,5 cm, suitable for 36 bowls
para bols de Ø 7,5 cm, apto para 36 bols
pour bols de Ø 7,5 cm, maxi 36 bols

	Ø cm	↑ cm		€
11991	17,5	25,5	Ständer inkl. 36 Glasschalen, Ø 7,5 cm / frame with 36 bowls, Ø 7,5 cm soporte con 36 bols, Ø 7,5 cm / support livré avec 36 bols en verre Ø 7,5 cm	92,00
11987	17,5	22,5	Ständer inkl. 36 Melaminschalen, Ø 7,5 cm / frame with 36 melamine bowls, Ø 7,5 cm soporte con 36 bols de melamina, Ø 7,5 cm / support avec 36 bols en mélamine Ø 7,5 cm	99,00

Schälchenspender „MEDIUM“ / bowl holder / rack dispensador para bols / porte-bols

	Ø cm	↑ cm		€
11990	17,5	25,5	Ständer ohne Schalen / frame without bowls soporte sin bols / support sans bols	46,00



Schälchen „CASUAL MINI“

bowl
cuenco
bol mini



	Ø cm	↑ cm	ltr.	€
83880	6,0	2,5	0,02	1,70
83881	7,5	3,5	0,05	2,10



Schale

bowl
cuenco
bol



	Ø cm	↑ cm	ltr.	pcs.	€ / pc.
11859	6,0	2,5	0,05	36	1,30
11866	7,5	3,5	0,09	36	1,40

**Vorratsglas „WOODY“**

canister with lid

bote con tapa

pot en verre avec couvercle

**Holzdeckel mit Silikondichtung**
wooden lid with silicone gasketGLAS
GLASSHOLZ
WOODSILIKON
SILICON**Glasbehälter mit Holzdeckel, aromadichter Verschluss**

glass container, aroma-tight screw cap

recipiente de cristal, tapa con cierre hermético para conservar el aroma

récipient en verre, couvercle avec fermeture hermétique pour conserver l'arôme

	cm	↑ cm	ltr.	€
82255	14 x 14	11,0	1,0	8,20
82256	14 x 14	17,0	2,0	8,60
82257	14 x 14	21,5	2,5	9,40

**Vorratsglas „CLASSIC“**

canister with lid

bote con tapa

pot en verre avec couvercle

GLAS
GLASSPE
POLYETHYL.**inkl. Glasdeckel mit Dichtung. Somit bleibt Ihre Ware frisch**

incl. glass lid with seal. Thus, your goods remain fresh

incl. tapa de vidrio con junta. Por lo tanto, sus productos permanecen frescos

y compris couvercle en verre avec joint. Ainsi, vos marchandises restent fraîches

	Ø cm	↑ cm	ltr.	€
82250	11,5	16,0	0,9	5,20
82251	14,0	21,5	2,0	9,40
82252	18,0	26,0	4,0	14,80
82253	20,0	30,0	6,0	17,20



2 ltr.

Vorratsglas mit luftdichtem Klappdeckel

glass with airtight cover
bote con cierre hermético
pot en verre avec fermeture hermétique



	cm	↑ cm	ltr.	€
82328	12 x 12	22	2	6,20

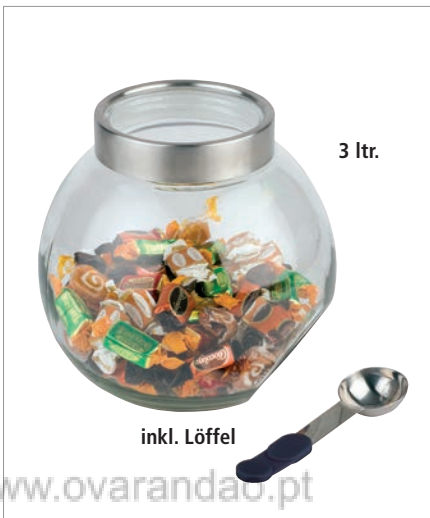

3 ltr.

inkl. Löffel

Vorratsglas

canister with lid
bote con tapa
pot en verre avec couvercle



Glaskugel mit Löffel, Schraubdeckel mit aromadichtem Verschluss, Edelstahl-Löffel mit magnetischem Silikongriff, 1 Stck.
tight cover, stainless steel spoon with magnetic silicone handle, 1 pc.
tapa a rosca con cierre hermético, cuchara de acero inoxidable con mango de silicona magnético, 1 pza
couvercle à vis avec fermeture hermétique, cuillère en acier inox avec manche de silicone aimanté, 1 pc.

	Ø cm	↑ cm	ltr.	€
00636	20	18	3	10,80



1 ltr.

Vorratsglas

canister with lid
bote con tapa
pot en verre avec couvercle



Glaskugel mit Schraubdeckel, aromadichtem Verschluss, 1 Stck.
glass ball, aroma-tight screw cap, 1 pc.
bote de cristal, tapa a rosca para conservar el aroma, 1 pza
pot en verre, couvercle à vis pour conserver l'arôme, 1 pc.

	cm	↑ cm	ltr.	€
00637	12,5 x 19	18	1	7,20



stapelbar

↑ Frontklappe

11884

11885

Universalbox

box / sweetbox
caja dispensadora
boîte distributrice



ideal als Verkaufsbox, mit Frontdeckel
best to present sweets etc., all-purpose, with front lid
la perfecta solución para presentar golosinas, universal, con tapa frontal
la solution idéale pour les friandises et autres, universel, avec couvercle frontal

	cm	↑ cm	Farbe / Colour	€
11884	23 x 14,5	15		11,00
11885	23 x 14,5	15		11,00

**Hygieneschutz**

hygienic cover
cubierta higiénica antialiento
pare-haleine



	cm	↑ cm	€
11556	82 x 42	45	194,00

**Brötchenspender**

roll dispenser
dispensador de panecillos
distributeur de petits pains



hygienisch und einfach zu reinigen, mit Krümelschale
hygienic and easy to clean, with crumb tray
higiénico y fácil de limpiar, con bandeja para migas
hygiénique et facile à laver, avec plat ramasse-miettes

	cm	↑ cm		€
11572	32,5 x 27,5	42	für ca. 45 - 50 Brötchen / for approx. 45 - 50 rolls para 45-50 panecillos / pour 45-50 petits pains	194,00
11573	32,5 x 27,5	56	für ca. 65 - 70 Brötchen / for approx. 65 - 70 rolls para 65-70 panecillos / pour 65-70 petits pains	219,00

Deckel / Cover / tapa / couvercle seul

	cm	↑ cm	€
11562	33,5 x 21,5	4	18,40

**Universalbox**

universal box
caja dispensadora
boîte distributrice



ideal für Zucker, Milch und Gebäck, 3 Fächer

best for sugar, milk and biscuits, 3 compartments
la perfecta solución para a zúcar, leche y galletas, 3 compartimentos
la solution idéale pour sucre, lait et biscuits, 3 compartiments

	cm	↑ cm	€
11886	41,5 x 20,5	16	29,00

**Teebox / Multibox**

tea caddy
caja para té
boîte à thés et infusions



3 Fächer für kuvertierte Teebeutel, 1 Fach für Zucker, Kekse, etc., Deckel aufklappbar
4 chambers
4 compartimentos
4 compartiments

	cm	↑ cm	€
11563	22 x 17	9	17,00



NEW

Teebox „VINTAGE“

tea-box
caja para té
boîte à thé et infusions



Holzbox mit Sichtfenster, 4 Kammern können mit je 30 kuvertierten Teebeuteln bestückt werden

wooden box with clear transparent window, 4 chambers for approx. 30 tea bags each

caja de madera clara con ventana transparente, 4 compartimentos, para aproximadamente 30 bolsas de té

en bois clair avec fenêtre, 4 compartiments, pour environ 30 sachets

	cm	↑ cm	Farbe / Colour	€
11570	32 x 20	10		24,00



NEW

Teebox „VINTAGE“

tea-box
caja para té
boîte à thé et infusions



Holzbox mit Sichtfenster, 4 Kammern können mit je 30 kuvertierten Teebeuteln bestückt werden

wooden box with clear transparent window, 4 chambers for approx. 30 tea bags each

caja de madera clara con ventana transparente, 4 compartimentos, para aproximadamente 30 bolsas de té

en bois clair avec fenêtre, 4 compartiments, pour environ 30 sachets

	cm	↑ cm	Farbe / Colour	€
11571	32 x 20	10		24,00



11575

11574

Teebox

tea-box
caja para té
boîte à thé et infusions



Holzbox mit Sichtfenster, mit Aufschrift „Tee“, 4 Kammern können mit je 30 kuvertierten Teebeuteln bestückt werden

wooden box with clear transparent window, with inscription „Tee“, 4 chambers for approx. 30 tea bags each

caja de madera clara con ventana transparente, con inscripción „Tee“, 4 compartimentos, para aproximadamente 30 bolsas de té

en bois clair avec fenêtre, marquée „TEE“, 4 compartiments, pour environ 30 sachets

	cm	↑ cm	Farbe / Colour	€
11575	33,5 x 20	9		17,00
11574	33,5 x 20	9		17,00

	cm	↑ cm	Farbe / Colour	€
11576	33,5 x 20	9		17,00

ohne Aufschrift / without inscription
sin inscripción / sans inscription



11775

11776

Teebox

tea-box
caja para té
boîte à thé et infusions



Holzbox mit Sichtfenster, mit Aufschrift „Tee“, 12 Kammern können mit je 12 kuvertierten Teebeuteln bestückt werden

wooden box with clear transparent window, with inscription „Tee“, 12 chambers for approx. 144 tea bags each

caja de madera clara con ventana transparente, con inscripción „Tee“, 12 compartimentos, para aproximadamente 144 bolsas de té

en bois clair avec fenêtre, marquée „TEE“, 12 compartiments, pour environ 144 sachets

	cm	↑ cm	Farbe / Colour	€
11775	31 x 28	9		23,00
11776	31 x 28	9		23,00

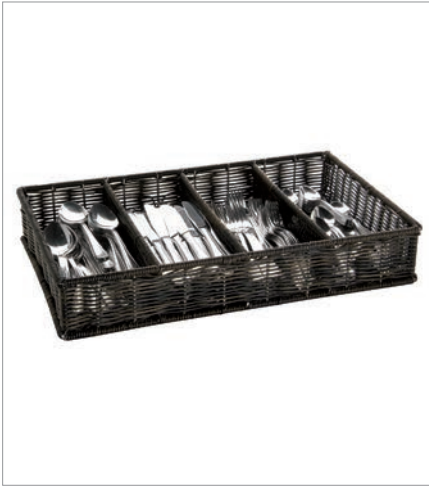

GN 1/1 Besteckbehälter

GN 1/1 dispenser GN
GN 1/1 dispensador de cubiertos
GN 1/1 bac à couverts



in Handarbeit geflochten, 4 Mulden, Kunststoff-Geflecht, Drahtgestell, braun-schwarz

wickerwork, 4 compartments, with reinforced chromed wire structure, brown-black

cesta trensada a mano, 4 compartimentos, de plástico, con bastidor cromado reforzado, marrón oscuro

corbeille tressée à main, 4 compartiments, en plastique, cadre acier chromé renforcé, couleur marron foncé

	cm	↑ cm	Farbe / Colour	€
11966	53 x 32,5	9		34,00



GN 1/1 Besteckbehälter „BUFFET“

GN 1/1 cutlery dispenser
GN 1/1 dispensador de cubiertos
GN 1/1 bac à couverts



4 Mulden, Kunststoff-Geflecht, Drahtgestell, beige

4 troughs, wickerwork, wire, beige

4 huecos, trabajo de cestería

4 compartiments, plastique tressé, cadre acier chromé renforcé, couleur osier naturel

	cm	↑ cm	Farbe / Colour	€
11965	53 x 32,5	10		24,00



GN 1/1 Besteckbehälter

GN 1/1 cutlery tray / box stand
GN 1/1 dispensador de cubiertos
GN 1/1 bac à couverts



	cm	↑ cm	Farbe / Colour	€
11955	53 x 32,5	10		6,00



GN 1/1 Besteckkasten

cutlery box GN 1/1
GN 1/1 dispensador de cubiertos
GN 1/1 bac à couverts



	cm	↑ cm	Farbe / Colour	€
11960	53 x 32,5	10		6,60





11998

Köcher weiß
PE white

11999

Köcher Edelstahl
stainless steel

Besteckköcher

cutlery basket
cesta para cubiertos
corbeille à couverts



	Ø cm	↑ cm		€
11998	9,7	13,7	Kunststoff weiß / white plastic plástico blanco / plastique blanc	2,50
11999	9,7	13,7	matt poliert / satin polished finish acero inoxidable / inox	7,90



11994

11997

Besteckbehälter

cutlery basket
dispensador de cubiertos
présentoir à couverts

matt poliert

satin polished finish

inox mate (sin cubiertos)

inox mat



	cm	↑ cm		€
11994	26,0 x 30 Ø 10	20	4 Löcher inkl. Köcher (Kunststoff) 4 holes incl. dispensers (plastic) 4 agujeros incl. dispensador plástico 4 places, avec 4 récipients (plastique)	62,00
11997	37,5 x 30 Ø 10	20	6 Löcher ohne Köcher 6 holes without dispensers 6 agujeros sin dispensador de plástico 6 places, sans récipients	77,00



Besteckbehälter

cutlery basket
recipiente para cubiertos
récipients pour couverts

4 Löcher inkl. 4 Edelstahl Köcher

4 holes incl. 4 stainless baskets

4 agujeros, incl. 4 cestas de acero

4 places, avec 4 corbeilles inox



	cm	↑ cm	Farbe / Colour	€
93321	27 x 27	15		69,00



Besteckbehälter „ELEMENT“

cutlery bin
recipiente para cubiertos
récipients pour couverts

mit Abflussloch, mit Besteck Logo, Bodeneinlage aus Silikon
zum Schonen des Bestecks, möbelschonende Unterseite

with drain hole, with cutlery logo, silicone floor insert
for saving the cutlery, with non-scratching undersurface

con orificio de drenaje, con logotipo de cubertería, base de silicona
para proteger la cubertería, con base anti rayaduras

avec trou de drainage, avec logo de coutellerie, insert de silicone
pour protéger la coutellerie, avec revêtement antirayures



	Ø cm	↑ cm		€
00018	11	14		15,00



NEW



11935



11936



11937

Besteckbehälter „ELEMENT“

cutlery bin
recipiente para cubiertos
récipients pour couverts



mit Abflussloch, mit weißem Logo, Bodeneinlage aus Silikon zum Schonen des Bestecks, möbelschonende Unterseite
with drain hole, with white logo, silicone floor inserts for saving the cutlery, with non-scratching undersurface
con orificio de drenaje, con logotipo blanco, base de silicona para proteger la cuberteria, con base anti rayaduras
avec trou de drainage, avec logo blanc, insert de silicone pour proteger la coutellerie, avec revêtement antirayures

	Ø cm	↑ cm	Logo	€
11935	12	14	fork	14,50
11936	12	14	knife	14,50
11937	12	14	spoon	14,50



NEW

Besteckbehälter „ACACIA“

cutlery bin
recipiente para cubiertos
récipients pour couverts



Akazienholz natur
acacia wood nature
madera de acacia natural
bois d'acacia naturelle

	cm	↑ cm	Logo	€
11939	14 x 14	15	fork / knife / spoon	14,00

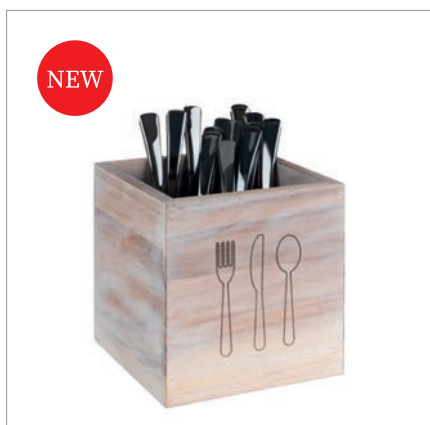

NEW

Besteckbehälter „VINTAGE“

cutlery bin
recipiente para cubiertos
récipients pour couverts



Akazienholz vintage weiß
acacia wood, vintage white
madera de acacia, blanca vintage
bois d'acacia, blanc vintage

	cm	↑ cm	Logo	€
11938	14 x 14	15	fork / knife / spoon	14,00



02039

Tischrestehälter

table garage bin
papelera de sobremesa
poubelle de table



	Ø cm	↑ cm	ltr.	Farbe / Colour	€
02038	11	14	0,9		2,60
02039	11	14	0,9		2,60

**Tischrestehälter „INTERNATIONAL“**

table waste bin
papelera de sobremesa
poubelle de table

**Deckel-Ring mit Dichtung, internationale Beschriftung**

cover with sealing ring
tapa con junta, texto multi-idiomas
couvercle avec joint, texte multilingue

	Ø cm	↑ cm	ltr.	€
83847	10	17,5	1	9,00

**Tischrestehälter**

table garbage bin
papelera de sobremesa
poubelle de table

**Behälter aus weiß lackiertem Metall, abnehmbarer Schwingdeckel**

cover stainless steel bin metal, white, swing cover
tapa de acero inoxidable, recipiente chapa lacada blanca
couvercle inox basculant, récipient en acier laqué blanc

	Ø cm	↑ cm	ltr.	€
00291	12	17	1,2	16,00

**Tischrestehälter**

table garbage bin
papelera de sobremesa
poubelle de table

**Behälter aus weiß lackiertem Metall, Edelstahl-Lochdeckel**

metall white, stainless cover with hole
tapa, acero inoxidable, con apertura
couvercle inox, avec ouverture centrale, récipient en acier laqué blanc

	Ø cm	↑ cm	ltr.	€
00292	12	15	1,2	16,00

**Tischrestehälter „SUNDAY“**

table waste bin
papelera de sobremesa
poubelle de table

**matt poliert, inkl. Deckel, fester Deckelsitz**

satin polished finish, incl. cover, cover removeable
acero inoxidable mate, con tapa
inox mat, avec couvercle

	Ø cm	↑ cm	ltr.	€
00024	10	18	1,1	23,90

**Tischrestebehälter**

table garbage bin
papelera de sobremesa
poubelle de table



Behälter (innen Ø 9 cm) für Besteck, Servietten etc., vielseitig einsetzbar
bins (inner Ø 9 cm) for cutlery, napkins etc., versatile applicable
recipientes Ø 9 cm para cubiertos, servilletas etc.
récipients Ø 9 cm, pour couverts, serviettes,...

	Ø cm	↑ cm	ltr.	€
83999	13	14	1,2	11,50

**Tischreste- / Besteckbehälter**

table garbage bin / cutlery bin
papelera de sobremesa / recipiente para cubiertos
poubelle de table / récipients pour couverts



matt poliert, mit abnehmbaren Lochdeckel
satin polished finish, with removeable cover
acabado pulido satinado, con tapa desmontable
poli mat satiné, avec couvercle démontable ouvert au centre

	Ø cm	↑ cm	ltr.	€
00028	10	12	0,7	12,00

**Tischrestebehälter**

table garbage bin
papelera de sobremesa
poubelle de table



matt poliert, abnehmbarer Schwingdeckel, mit Bajonettverschluss „fester Deckelsitz“
satin polished finish, swing cover, cover removable
acabado satinado, tapa basculante desmontable
poli mat satiné, couvercle basculant démontable

	Ø cm	↑ cm	ltr.	€
00029	12	17	1,2	16,00
00027	10	13	0,7	12,00

**Table Caddy „COUNTRY STYLE“**

table barrel
caddy de mesa
caddy de table



cooler Country-Style, nicht für den direkten Kontakt mit Lebensmittel verwendbar
make for cool condiment and cutlery holders or even for food presentation, the mini barrels should not come into contact with food, they should be lined with our greaseproof paper
estilo campo, no aptos para el contacto directo con alimentos, sólo usando papel alimenticio
de style champêtre, pas de contact direct avec aliments, seulement en utilisant papier alimentaire

	Ø cm	↑ cm	€
11930	17,5	8,5	19,00
11931	11,5	14,0	19,00



**Tischreste- / Besteckbehälter „TOP CHROME“**

table waste bin / cutlery bin
 papelera de sobremesa / recipiente para cubiertos
 poubelle de table / récipients pour couverts



mit verchromten Rand
 with chrome plated ring
 con anillo cromado
 avec bord chromé

	Ø cm	↑ cm	ltr.	Farbe / Colour	€
00025	13	15	1	White	6,00
00026	13	15	1	Black	6,00

**Tischreste- / Besteckbehälter „BASE CHROME“**

table waste bin / cutlery bin
 papelera de sobremesa / recipiente para cubiertos
 poubelle de table / récipients pour couverts



mit verchromten Boden
 with chrome bottom
 con base cromada
 avec base chromée

	Ø cm	↑ cm	ltr.	Farbe / Colour	€
00019	13	15	1,3	White	6,00
00020	13	15	1,3	Black	6,00

**Besteckständer „TRIPLE TOWER“**

cutlery basket
 cesta para cubiertos
 égouttoir à couverts



4-teiliges Set: 1 Gestell + 3 Köcher
 4 pcs. set: 1 frame + 3 baskets
 set de 4: 1 estructura + 3 cubiertos
 set de 4: 1 structure + 3 corbeilles

	cm	↑ cm	Farbe / Colour	€
11466	18 x 26	43	White	79,00
11467	18 x 26	43	Black	79,00

**Besteckköcher**

cutlery basket
 cesta para cubiertos
 corbeille à couverts



	cm	↑ cm	Farbe / Colour	€
84535	12 x 12	16	White	4,90
84536	12 x 12	16	Black	4,90

**Tischkrümelentferner**

crumber
 recogemigas
 ramasse-miettes



matt poliert
 satin polished finish
 acabado mate, fácil de usar, mango hueco
 mat satiné, manche creux, simple à utiliser

	Ø cm	↑ cm		€
00058	6,5 x 2,5	22	Hohlgriff / hollow handles	14,80
00581	19,0 x 4,5	1	geschliffene Edelstahlkante flat grinded stainless steel edge	7,20



hot price

Tischrestebehälter
table garbage bin
papelera de sobremesa
poubelle de table



	Ø cm	↑ cm	ltr.	€
00311	14	15	1,2	3,60



hot price

Tischrestebehälter
table garbage bin
papelera de sobremesa
poubelle de table



Kunststoff weiß / Granit, abnehmbarer Schwingdeckel
white plastic, swing cover, cover removable
plástico blanco/granito, tapa basculante desmontable
plastique blanc/gris chiné, couvercle basculant démontable

	Ø cm	↑ cm	ltr.	€
00031	12	18	1,4	5,40



matt poliert
satin polished finish

10 cm

11921

11922

13,5 cm

Besteckständer
cutlery basket
cesta para cubiertos
égouttoir à couverts



	Ø cm	↑ cm	€
11921	10	10,0	7,40
11922	12	13,5	9,90



Tischreste- / Besteckbehälter
table waste bin / cutlery bin
papelera de sobremesa / recipiente para cubiertos
poubelle de table / récipients pour couverts



mit verchromten Rand, inkl. herausnehmbarem Einteiler (4 Fächer)
with chrome plated ring, incl. divider (4 chambers)
con anillo cromado, incl. divisor extraíble (4 compartimentos)
avec bod chrome, incl. paroi de separation amovible (4 compartiments)

	cm	↑ cm	€
00016	14 x 14	16	19,00

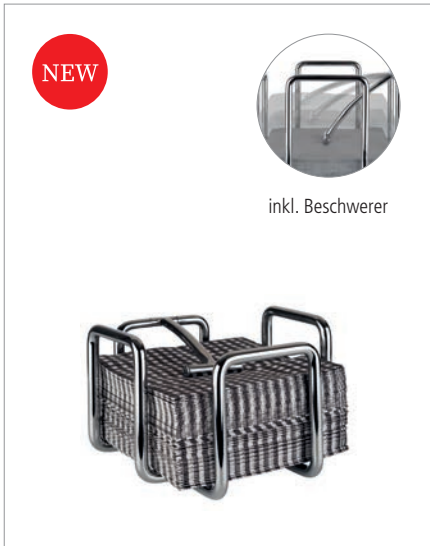
**Serviettenhalter „HERO“**

napkin holder
servilletero
porte-serviettes



für ca. 65 Cocktailservietten, inkl. Beschwerer
for approx. 65 cocktail napkins, incl. weight
para aprox. 65 servilletas cocktail, incl. barra de contrapeso
pour environ 65 serviettes cocktail, incl. barre de contrepoids

	cm	↑ cm		€
11767	14,5 x 14,5	10	für 65 Servietten / for 65 napkins para 65 servilletas / pour 65 serviettes	9,00

**Serviettenhalter „HERO“**

napkin holder
servilletero
porte-serviettes



für ca. 95 Servietten 1/4 Falz, inkl. Beschwerer
for approx. 95 cocktail napkins, incl. weight
para aprox. 95 servilletas cocktail, incl. barra de contrapeso
pour environ 95 serviettes cocktail, incl. barre de contrepoids

	cm	↑ cm		€
11768	18,5 x 18,5	14	für 95 Servietten / for 95 napkins para 95 servilletas / pour 95 serviettes	12,00

**Serviettenhalter „PROFI“**

napkin holder
servilletero
porte-serviettes



für 150 Servietten 1/4 Falz, inkl. Beschwerer, mit Antirutschfüßchen, absolut standfest
for 150 napkins 1/4 fold, incl. weight, non-slip feet, very stable
para 150 servilletas plegado 1/4, incl. barra de contrapeso, con pies antideslizantes, muy estable
pour 150 serviettes pliage 1/4, incl. barre de contrepoids, avec pieds antidérapants, très stable

	cm	↑ cm		€
11766	18,5 x 18,5	18	für 150 Servietten / for 150 napkins para 150 servilletas / pour 150 serviettes	35,00

**Serviettenhalter**

napkin holder
servilletero
porte-serviettes



hochglanzpoliert, für Servietten mit 1/8 Falz, Füße mit rutsch- und kratzfester Gummierung
mirror polished finish, for napkins with 1/8 fold, rubber feet
pulido brillante, para servilletas plegado 1/8, con revestimiento de goma
poli miroir, pour serviettes pliage 1/8, avec revêtement en caoutchouc

	cm	↑ cm		€
11720	10 x 11,5	18,5		11,60

**Serviettenhalter „ELEMENT“**

napkin holder
servilletero
porte-serviettes



aus Beton, für ca. 50 Servietten, mit möbelschonender Unterseite
concrete, for approx. 50 napkins, with furniture-friendly underside
hormigón, para aprox. 50 servilletas, con base anti rayaduras
béton, pour environ 50 serviettes, avec revêtement antirayures

	cm	↑ cm		€
11781	16 x 7,5	10	für 50 Servietten / for 50 napkins para 50 servilletas / pour 50 serviettes	9,00

**Serviettenhalter „WIRE“**

napkin holder
servilletero
porte-serviettes



für Servietten 1/4 Falz, inkl. Beschwerer
for napkins 1/4 fold, incl. weight
para servilletas plegado 1/4, incl. barra de contrapeso
pour serviettes pliage 1/4, incl. barre de contrepoids

	cm	↑ cm		€
11763	19 x 19	6,5	für 50 Servietten / for 50 napkins para 50 servilletas / pour 50 serviettes	5,90
11765	19 x 19	19,0	für 150 Servietten / for 150 napkins para 150 servilletas / pour 150 serviettes	9,40

**Serviettenhalter „BAR“**

napkin holder
servilletero
porte-serviettes



für ca. 50 Cocktailservietten, inkl. Beschwerer
for approx. 50 cocktail napkins, incl. weight
para aprox. 50 servilletas cocktail, incl. barra de contrapeso
pour environ 50 serviettes cocktail, incl. barre de contrepoids

	cm	↑ cm		€
11762	14 x 14	6,5	für 50 Servietten / for 50 napkins para 50 servilletas / pour 50 serviettes	5,90

**Serviettenhalter**

napkin holder
servilletero
porte-serviettes



matt poliert
satin polished finish
acabado satinado
mat satiné

	cm	↑ cm		€
11730	17 x 17	5		16,80

**Serviettenhalter**

napkin holder
servilletero
porte-serviettes



möbelschonende Unterseite, für ca. 30 Servietten, matt poliert
furniture-friendly underside, for approx. 30 napkins, satin polished finish
con base anti rayaduras, para aprox. 30 servilletas, pulido mate
avec revêtement antirayures, pour environ 30 serviettes, poli mat

	cm	↑ cm		€
11780	15 x 4,5	12,5	für 30 Servietten / for 30 napkins para 30 servilletas / pour 30 serviettes	6,20

**Serviettenhalter**

napkin holder
servilletero
porte-serviettes



möbelschonende Unterseite, für ca. 20 Servietten, matt poliert
furniture-friendly underside, for approx. 20 napkins, satin polished finish
con base anti rayaduras, para aprox. 20 servilletas, pulido mate
avec revêtement antirayures, pour environ 20 serviettes, poli mat

	cm	↑ cm		€
11778	17 x 3	7	für 20 Servietten / for 20 napkins para 20 servilletas / pour 20 serviettes	6,40



11631

11633

Holzkiste „VINTAGE“

woodbox
caja madera
base bois



Schubladenoptik, mit Knopf
drawer look, with knob
look cajón, con pomo
look tiroir, avec bouton

	cm	↑ cm		€
11631	18,5 x 18,5	11	Innenmaß: 17 x 17 cm, mit Beschriftungsfach	13,00
11633	18,5 x 18,5	11	Innenmaß: 17 x 17 cm, mit Beschriftungsfach	13,00



Buffet & Tableware Melamin



Tablets
Schalen
Teller
Fingerfood
Eierbecher

trays
bowls
plates
finger food
egg holders

bandejas
cuencos
platos
finger food
hueveras

plateaux
bols
assiettes
finger food
coquetiers

NEW

HAPPY BUFFET



Schale „HAPPY BUFFET“

bowl, square
cuenco cuadrado
bol carré



	cm	↑ cm	ltr.	Farbe / Colour	€
15610	13 x 13	7	0,6		8,50
15611	13 x 13	7	0,6		8,50
15612	20 x 20	7	1,5		20,00
15613	20 x 20	7	1,5		20,00

Deckel „UNIVERSAL“ mit Löffelaussparung / cover with notched for spoons / tapa con espacio para la cuchara / couvercle avec encoche pour la louche

	cm	↑ cm	fits to	€
15345	20 x 20	1,5	15612, 15613	5,60



GN 1/4 Schale „HAPPY BUFFET“

GN 1/4 bowl
GN 1/4 cuenco
GN 1/4 bol



	cm	↑ cm	GN	ltr.	Farbe / Colour	€
15614	26,5 x 16,2	9	1/4	2,5		24,00
15615	26,5 x 16,2	9	1/4	2,5		24,00

Deckel „UNIVERSAL“ mit Löffelaussparung / cover with notched for spoons / tapa con espacio para la cuchara / couvercle avec encoche pour la louche

	cm	↑ cm	GN	fits to	€
15348	26,5 x 16,2	1,5	1/4	15614, 15615	6,00





Schale, rund „HAPPY BUFFET“

bowl, round
cuenco, redondo
bol rond



15602



15604



15606



15609



15341

	Ø cm	↑ cm	ltr.	Farbe / Colour	€
15600	6,5	6	0,15		2,60
15601	6,5	6	0,15		2,60
15602	6,5	6	0,15		2,60
15603	9,0	4	0,15		2,90
15604	9,0	4	0,15		2,90
15605	9,0	4	0,15		2,90
15606	13,0	7	0,60		6,60
15607	13,0	7	0,60		6,60
15608	20,0	7	1,50		17,00
15609	20,0	7	1,50		17,00



Deckel „UNIVERSAL“ mit Löffelaussparung / cover with notched for spoons / tapa con espacio para la cuchara / couvercle avec encoche pour la louche

	Ø cm	↑ cm	fits to	€
15341	20	1,5	15608, 15609	5,00

Buffetständer „ACACIA“

buffet stand
soporte para buffet
présentoir buffet



Akazienholz geölt / acacia wood oiled / madera de acacia aceitada / bois d'acacia huilé

	Ø cm	↑ cm	€
15620	20,0	10,5	22,00
15621	30,5	15,0	39,00
15622	30,5	20,0	42,00



15620



15621



15623

Buffetständer „ACACIA“

buffet stand
soporte para buffet
présentoir buffet



Akazienholz geölt / acacia wood oiled / madera de acacia aceitada / bois d'acacia huilé

	cm	↑ cm	GN	€
15623	53 x 16,2	20	2/4	44,00

APS+

UNIVERSAL



⊕ Kompatibilität / compatibility / combinación / compatibilité

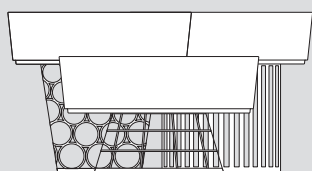

Baskets
risers

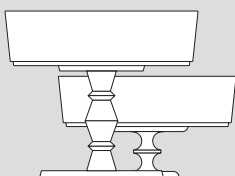

Wood
risers

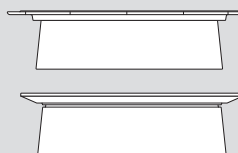

Bakery / Wood
plates

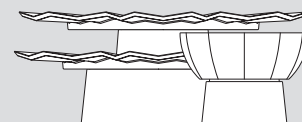

Lotus
bowls / plates



weiß; innen glänzend, außen matt
white; glossy on the inside, matt on the outside
blanco; interior brillante, exterior mate
blanc; intérieur brillant, extérieur mat



Holzdekor Ahorn & Farbe
maple wood decor & colour
textura de madera arce & color
aspect érable & couleur

bicolor
bicolour
bicolor
bicolore



Holzdekor Eiche dunkel & Farbe
oak wood decor & colour
textura de madera roble oscuro & color
aspect chêne foncé & couleur

bicolor
bicolour
bicolor
bicolore



Holzdekor Ahorn & cream

Holzdekor Eiche & cream

Holzdekor Ahorn & red

Holzdekor Eiche & red

Holzdekor Ahorn & green

Holzdekor Eiche & green

Holzdekor beige & cream

Holzdekor brown & cream



15116

GN 1/4 Schale „UNIVERSAL“

GN 1/4 bowl
GN 1/4 cuenco
GN 1/4 bol



	cm	↑ cm	GN	ltr.	Farbe / Colour	€
15116	26,5 x 16,2	7	1/4	1,5		15,00
15117	26,5 x 16,2	9	1/4	2,5		17,00

**Schale, quadratisch „APS+“**

bowl, square
cuenco cuadrado
bol carré



15111

	cm	↑ cm	ltr.	Farbe / Colour	€
15110	6,5 x 6,5	6	0,15	_____	2,20
15111	9,0 x 9,0	4	0,15	_____	2,50
15112	13,0 x 13,0	7	0,60	_____	6,00

**Schale, quadratisch „APS+“**

bowl, square
cuenco cuadrado
bol carré



15115

	cm	↑ cm	ltr.	Farbe / Colour	€
15113	20,0 x 20,0	7	1,5	_____	15,00
15114	24,0 x 24,0	9	3,5	_____	22,00
15115	26,5 x 26,5	9	4,0	_____	25,00

**Schale, rund „UNIVERSAL“**

bowl, round
cuenco, redondo
bol rond



15100

15102

	Ø cm	↑ cm	ltr.	Farbe / Colour	€
15100	6,5	6	0,15	_____	2,00
15101	9,0	4	0,15	_____	2,20
15102	13,0	7	0,60	_____	5,50

**Schale, rund „UNIVERSAL“**

bowl, round
cuenco, redondo
bol rond



15104

	Ø cm	↑ cm	ltr.	Farbe / Colour	€
15103	16,0	12	1,5	_____	12,00
15104	16,0	15	2,5	_____	14,00

**Schale, rund „UNIVERSAL“**

bowl, round
cuenco, redondo
bol rond



15106



15108

	Ø cm	↑ cm	ltr.	Farbe / Colour	€
15105	20,0	7	1,5	_____	14,00
15106	24,0	9	2,7	_____	18,00
15108	32,5	9	4,0	_____	30,00



GN 1/4 Schale „APS+“

GN 1/4 bowl
GN 1/4 cuenco
GN 1/4 bol



	cm	↑ cm	GN	ltr.	Farbe / Colour	€
15219	26,5 x 16,2	7	1/4	1,5		21,00
15220	26,5 x 16,2	9	1/4	2,5		24,00
15234	26,5 x 16,2	7	1/4	1,5		21,00
15235	26,5 x 16,2	9	1/4	2,5		24,00



Schale, quadratisch „APS+“

bowl, square
bol cuadrado
plat creux carré



	cm	↑ cm		ltr.	Farbe / Colour	€
15215	13,0 x 13,0	7		0,6		8,50
15216	20,0 x 20,0	7		1,5		20,00
15217	24,0 x 24,0	9		3,5		30,00
15218	26,5 x 26,5	9		4,0		34,00
15232	20,0 x 20,0	7		1,5		20,00
15233	26,5 x 26,5	9		4,0		34,00



Schale, rund „APS+“

bowl, round
cuenco, redondo
bol rond



	Ø cm	↑ cm		ltr.	Farbe / Colour	€
15230	20,0	7		1,5		17,00
15231	32,5	9		4,0		39,00



Schale „APS+“

bowl
cuenco
bol



	Ø cm	↑ cm		ltr.	Farbe / Colour	€
15200	6,5	6		0,15		2,50
15201	9,0	4		0,15		2,80



Schale „APS+“

bowl
cuenco
bol



	cm	↑ cm		ltr.	Farbe / Colour	€
15204	6,5 x 6,5	6		0,15		2,90
15205	9,0 x 9,0	4		0,15		3,20



APS+

ANTI PASTI

+ Kompatibilität / compatibility / combinación / compatibilité

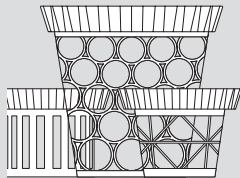

Baskets
risers

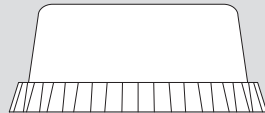

Cover
seal

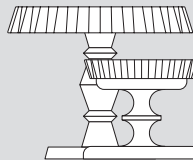

Wood
risers

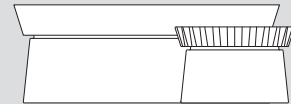

Bowls
risers



Schale „APS+ PLISSEE“

bowl
cuenco
bol



	Ø cm	↑ cm	Farbe / Colour	€
15142	35	4	White	24,00



Schale „APS+“

bowl
cuenco
bol



	Ø cm	↑ cm	Farbe / Colour	€
15135	14,5	2,5	White	3,90
15136	25,0	3,5	White	9,90
15137	35,0	4,0	White	18,00



Schale Water Lily „APS+“

leaf
fuente en forma de hoja
plat feuille



	Ø cm	↑ cm	ltr.	Farbe / Colour	€
15165	8,5	4	0,10	White	2,90
15166	13,0	6	0,30	White	5,40
15167	20,0	7	1,25	White	13,50

APS+

TILES



✚ Kompatibilität / compatibility / combinación / compatibilit 

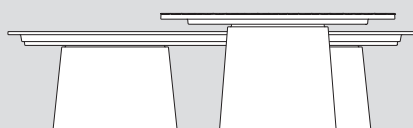

Bowls
risers

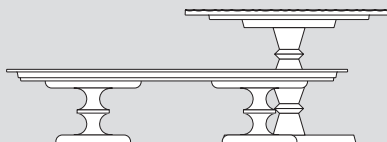

Wood
risers

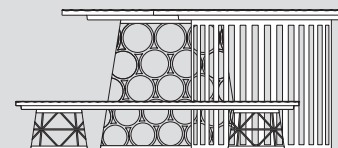

Baskets
risers



GN Tablett TILES „APS+“

GN tray
GN bandeja
GN plateau



	cm	↑ cm	GN	Farbe / Colour	€
15250	26,5 x 16,2	1,5	1/4	■	13,00
15251	32,5 x 17,5	1,5	1/3	■	17,00
15253	32,5 x 26,5	1,5	1/2	■	24,00
15252	53,0 x 16,2	1,5	2/4	■	24,00

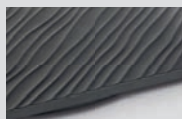



GN Tablett TILES „APS+“

GN tray
GN bandeja
GN plateau



	cm	↑ cm	GN	Farbe / Colour	€
15225	26,5 x 16,2	1,5	1/4		15,00
15226	32,5 x 17,5	1,5	1/3		19,00
15228	32,5 x 26,5	1,5	1/2		26,00
15227	53,0 x 16,2	1,5	2/4		26,00



Korb / Ständer „BASKET“

basket / riser
cesta / soporte
corbeille / support



	Ø cm	↑ cm	Farbe / Colour	€
15320	10,5 / 8	8		14,50
15324	10,5 / 8	8		14,50
15322	10,5 / 8	8		14,50

APS+

WOOD

+ Kompatibilität / compatibility / combinación / compatibilité

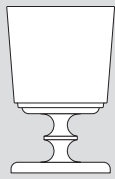

Universal
bowls

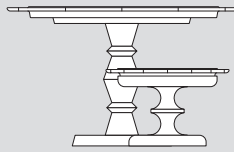

Tiles
plates

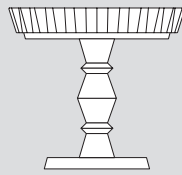

Antipasti
flat bowls

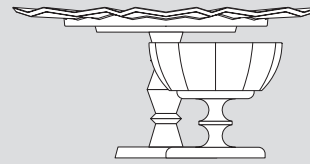

Lotus
plates / bowls

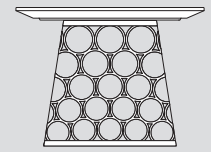

Baskets
risers



Tablett WOOD „APS+“

tray
bandeja
plateau



	Ø cm	↑ cm	Farbe / Colour	€
15300	30,0	2		39,00
15302	38,5	2		49,00



Tablett WOOD „APS+“

tray
bandeja
plateau



	Ø cm	↑ cm	Farbe / Colour	€
15301	30,0	2		39,00
15303	38,5	2		49,00



Ständer WOOD „APS+“

stand
soporte
support



	Ø cm	↑ cm	Farbe / Colour	€
15310	15 / 11,5	10,5		39,00
15311	15 / 11,5	10,5		39,00



Ständer WOOD „APS+“

stand
soporte
support



	Ø cm	↑ cm	Farbe / Colour	€
15312	21 / 15	20		49,00
15313	21 / 15	20		49,00

APS+

Hauben



Frischhalte-Haube „APS+“

cover
campana
cloche bombée



glasklar, Griff verchromt, schwere, stabile Ausführung

transparent, chrome knob, heavy stable quality

transparente, asa cromada, alta estabilidad

transparente, anse chromée, très stable

	Ø cm	↑ cm	✱ mm	fits to	€
15350	16,5	10	3	15130	8,90
15351	20,5	10	3	15141, 15136, 15271, 15131	9,90



Frischhalte-Haube

cover
campana
cloche



	Ø cm	↑ cm	fits to	€
06512	30	11,5	15142, 15137, 15272, 15132	6,20
06517	33	12,5	15133, 15302, 15303	6,90



Rolltophaube

rolltop cover
campana abatible
cloche basculante



glasklarer Kunststoff, leichtgängig auf- und zuklappen 90°

solid quality, to be opened 90°

plástico transparente de alta calidad, apertura a 90°

plastique transparent résistant, ouverture 90°

	Ø cm	↑ cm	fits to	€
18388	38	20	15302, 15303	21,00



Haube

cover
campana
cloche



	Ø cm	↑ cm	fits to	€
06519 <small>new</small>	21	17	15312, 15313	24,00
06520	30	22	15300, 15301	29,90
06521 <small>new</small>	36	27	15302, 15303	56,00

ASIA+



Nahezu alle ASIA+ Produkte verfügen über ein System von Ringen und Radien und können dadurch stand- und rutschfest miteinander kombiniert werden. So können beispielsweise alle Schalen auch als Riser / Aufsteller für unterschiedlichste weitere ASIA+ Produkte verwendet werden.

Nearly all ASIA+ products feature a system of rings and radii that allow them to be combined with each other in a stable manner. For example, all bowls can be used as risers for a wide range of other ASIA+ products. The same applies to the baskets.

Casi todos los productos de ASIA+ disponen de un sistema de anillos y radios que permiten su combinación entre sí con una estabilidad perfecta. Así por ejemplo, todos los cuencos se pueden utilizar también como pedestales para los productos más diversos de ASIA+. Y lo mismo ocurre con las cestas.

Presque tous les produits ASIA+ sont munis d'un système d'anneaux et de rayons, ce qui permet de les combiner entre eux de façon stable. Ainsi, tous les bols et saladiers servent aussi de rehausseurs pour les produits ASIA+ les plus divers. Il en va de même des corbeilles.



Tablett tray

Schale bowl



15523 / 15525
Tablett / tray

15524 / 15526
Zwischenplatte



Tablett „ASIA PLUS“

tray
bandeja
plateau



	Ø cm	↑ cm	Farbe / Colour	€
15530	30,0	3		22,00
15531	38,0	3		24,00
15532	48,5	3		34,00
15533	30,0	3		27,00
15534	38,0	3		34,00
15535	48,5	3		42,00



Tablett / Platte „ASIA PLUS“

tray
bandeja
plateau



	Ø cm	↑ cm		€
15523	38,0	2,5	einfach gefälzt / single seamed pliegue sencillo / plié une seule fois	34,00
15525	48,5	2,5	einfach gefälzt / single seamed pliegue sencillo / plié une seule fois	46,00



Zwischenplatte „ASIA PLUS“

intermediate plate
bandeja intermedia
plateau intermédiaire



	Ø cm	↑ cm		€
15524	38,0	2,5	doppelt gefälzt / double seamed pliegue doble / plié en double	34,00
15526	48,5	2,5	doppelt gefälzt / double seamed pliegue doble / plié en double	46,00

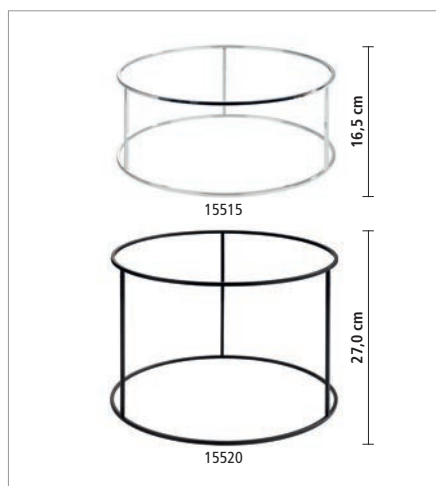

Buffetständer „ASIA PLUS“

buffet stand
soporte para buffet
présentoir buffet



	Ø cm	↑ cm	Farbe / Colour	€
15515	38,0	16,5		19,00
15516	38,0	27,0		22,00
15517	48,5	16,5		22,00
15518	48,5	27,0		29,00
15519	38,0	16,5		16,00
15520	38,0	27,0		19,00
15521	48,5	16,5		19,00
15522	48,5	27,0		26,00



GN Tablett „ASIA PLUS“

GN tray
GN bandeja
GN plateau



	cm	cm	GN	Parbe / Colour	€
15449	53,0 x 32,5	3	1/1	White	34,00
15450	32,5 x 26,5	3	1/2	White	19,00
15451	32,5 x 17,6	3	1/3	White	14,00
15452	26,5 x 16,2	3	1/4	White	11,00
15453	35,4 x 32,5	3	2/3	White	24,00
15454	53,0 x 16,2	3	2/4	White	22,00
15455	53,0 x 32,5	3	1/1	Black/Red	44,00
15456	32,5 x 26,5	3	1/2	Black/Red	25,00
15457	32,5 x 17,6	3	1/3	Black/Red	18,00
15458	26,5 x 16,2	3	1/4	Black/Red	15,00
15459	35,4 x 32,5	3	2/3	Black/Red	31,00
15460	53,0 x 16,2	3	2/4	Black/Red	28,00

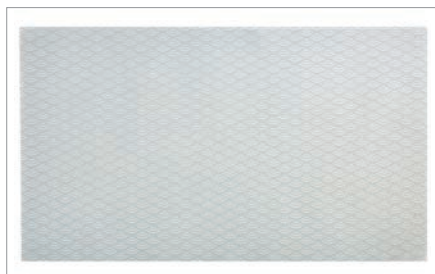

Antirutschmatte „ASIA PLUS“

non slip mat
esterilla antideslizante
tapis antidérapant



	cm	fits to	€
15497	51 x 31,0	15449, 15455	12,00
15499	31 x 25,5	15450, 15456	7,40



Antirutschmatte „ASIA PLUS“

non slip mat
esterilla antideslizante
tapis antidérapant



	cm	fits to	€
15498	51 x 31,0	15449, 15455	12,00
15500	31 x 25,5	15450, 15456	7,40

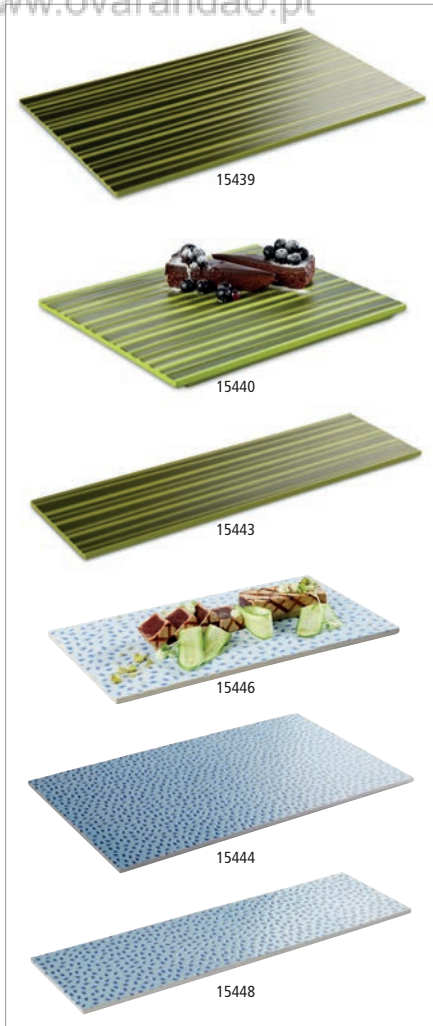

GN Tablett „ASIA PLUS“
GN tray
GN bandeja
GN plateau



	cm	↑ cm	GN	Farbe / Colour	€
15439	53,0 x 32,5	1,5	1/1		44,00
15440	32,5 x 26,5	1,5	1/2		25,00
15441	32,5 x 17,6	1,5	1/3		20,00
15442	26,5 x 16,2	1,5	1/4		16,00
15443	53,0 x 16,2	1,5	2/4		28,00
15444	53,0 x 32,5	1,5	1/1		44,00
15445	32,5 x 26,5	1,5	1/2		25,00
15446	32,5 x 17,6	1,5	1/3		20,00
15447	26,5 x 16,2	1,5	1/4		16,00
15448	53,0 x 16,2	1,5	2/4		28,00

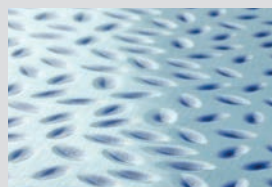
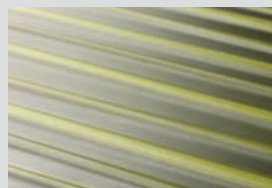

	GN 1/2	GN 1/4	
GN 1/1			GN 2/4
	GN 1/2	GN 1/4	
GN 1/3	GN 1/3	GN 1/3	



Schale „ASIA PLUS“

bowl
cuenco
bol



	Ø cm	↑ cm	ltr.	Farbe / Colour	€
15400	7,5	3,5	0,06	■ ■	2,00
15401	9,5	4,5	0,13	■ ■	3,00
15402	13,0	5,5	0,35	■ ■	5,00
15403	16,0	7,0	0,60	■ ■	7,00
15404	20,0	8,0	1,10	■ ■	11,40
15405	24,0	9,5	2,20	■ ■	17,00
15406	26,5	11,0	3,00	■ ■	22,00
15407	32,5	12,5	5,40	■ ■	30,00
15408	7,5	3,5	0,06	■ ■	2,00
15409	9,5	4,5	0,13	■ ■	3,00
15410	13,0	5,5	0,35	■ ■	5,00
15411	16,0	7,0	0,60	■ ■	7,00
15412	20,0	8,0	1,10	■ ■	11,40
15413	24,0	9,5	2,20	■ ■	17,00
15414	26,5	11,0	3,00	■ ■	22,00
15415	32,5	12,5	5,40	■ ■	30,00
15416	7,5	3,5	0,06	■ ■	2,00
15417	9,5	4,5	0,13	■ ■	3,00
15418	13,0	5,5	0,35	■ ■	5,00
15419	16,0	7,0	0,60	■ ■	7,00
15420	20,0	8,0	1,10	■ ■	11,40
15421	24,0	9,5	2,20	■ ■	17,00
15422	26,5	11,0	3,00	■ ■	22,00
15423	32,5	12,5	5,40	■ ■	30,00

Deckel „UNIVERSAL“ mit Löffelaussparung

cover with notched for spoons
tapa con espacio para la cuchara
couvercle avec encoche pour la louche



	Ø cm	↑ cm	fits to	€
15340	16,0	1,5	15403, 15411, 15419	4,50
15341	20,0	1,5	15404, 15412, 15420	5,00
15342	24,0	1,5	15405, 15413, 15421	6,00
15343	26,5	1,5	15406, 15414, 15422	6,80
15344	32,5	1,5	15407, 15415, 15423	10,00



Teller „ASIA PLUS“
plate
plato
assiette



	Ø cm	↑ cm	Farbe / Colour	€
15424	11,0	2	[White]	2,60
15425	16,0	2	[White]	4,60
15426	19,5	2	[White]	6,00
15427	24,0	2	[White]	9,00
15428	28,0	2	[White]	12,40

	Ø cm	↑ cm	Farbe / Colour	€
15429	11,0	2	[White/Blue]	2,60
15430	16,0	2	[White/Blue]	4,60
15431	19,5	2	[White/Blue]	6,00
15432	24,0	2	[White/Blue]	9,00
15433	28,0	2	[White/Blue]	12,40

	Ø cm	↑ cm	Farbe / Colour	€
15434	11,0	2	[Red/Black]	2,60
15435	16,0	2	[Red/Black]	4,60
15436	19,5	2	[Red/Black]	6,00
15437	24,0	2	[Red/Black]	9,00
15438	28,0	2	[Red/Black]	12,40







Bento Box „ASIA PLUS“



	Ø cm	↑ cm	ltr.	Farbe / Colour	€
15461	7,5	3,0	0,04		1,90
15462	7,5	6,5	0,13		2,60



	Ø cm	↑ cm	ltr.	Farbe / Colour	€
15467	7,5	3,0	0,04		2,70
15468	7,5	6,5	0,13		3,90



	cm	↑ cm	ltr.	Farbe / Colour	€
15473	7,5 x 7,5	3,0	0,05		2,00
15474	7,5 x 7,5	6,5	0,16		2,80
15479	15,5 x 15,5	3,0	0,19		5,20
15480	15,5 x 15,5	6,5	0,85		7,50



	cm	↑ cm	ltr.	Farbe / Colour	€
15485	7,5 x 7,5	3,0	0,05		3,40
15486	7,5 x 7,5	6,5	0,16		4,20
15491	15,5 x 15,5	3,0	0,19		9,00
15492	15,5 x 15,5	6,5	0,85		15,80



	cm	↑ cm	ltr.	Farbe / Colour	€
15475	15,5 x 7,5	3,0	0,10		3,40
15477	15,5 x 9,5	3,0	0,15		3,60
15476	15,5 x 7,5	6,5	0,40		4,60
15478	15,5 x 9,5	6,5	0,50		5,40
15483	25,0 x 15,5	3,0	0,30		8,00
15484	25,0 x 15,5	6,5	1,40		11,00



	cm	↑ cm	ltr.	Farbe / Colour	€
15487	15,5 x 7,5	3,0	0,10		6,40
15488	15,5 x 7,5	6,5	0,40		8,00
15489	15,5 x 9,5	3,0	0,15		7,20
15490	15,5 x 9,5	6,5	0,50		9,40
15495	25,0 x 15,5	3,0	0,30		11,60
15496	25,0 x 15,5	6,5	1,40		14,40



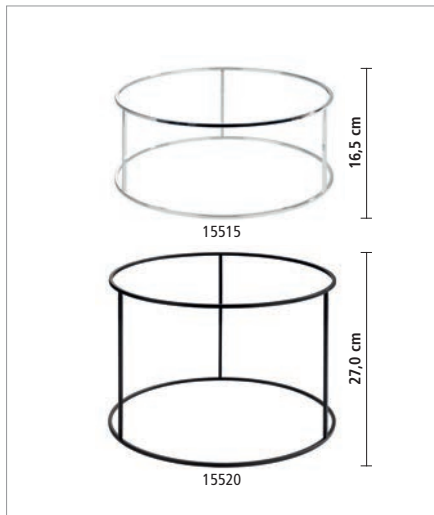

Buffetständer „ASIA PLUS“

buffet stand
soporte para buffet
présentoir buffet



	Ø cm	↑ cm	Farbe / Colour	€
15515	38,0	16,5	■	19,00
15516	38,0	27,0	■	22,00
15517	48,5	16,5	■	22,00
15518	48,5	27,0	■	29,00
15519	38,0	16,5	■	16,00
15520	38,0	27,0	■	19,00
15521	48,5	16,5	■	19,00
15522	48,5	27,0	■	26,00



GN Buffetständer „ASIA PLUS“

GN buffet stand
GN soporte para buffet
GN présentoir buffet



	cm	GN	Farbe / Colour	€
15501	53,0 x 32,5 / 53,0 x 16,2	1/1 / 2/4	■	24,00
15502	32,5 x 26,5 / 26,5 x 16,2	1/2 / 1/4	■	15,00
15503	32,5 x 17,5 / 35,4 x 32,5	1/3 / 2/3	■	19,00
15504	53,0 x 32,5 / 53,0 x 16,2	1/1 / 2/4	■	19,00
15505	32,5 x 26,5 / 26,5 x 16,2	1/2 / 1/4	■	12,00
15506	32,5 x 17,5 / 35,4 x 32,5	1/3 / 2/3	■	15,00

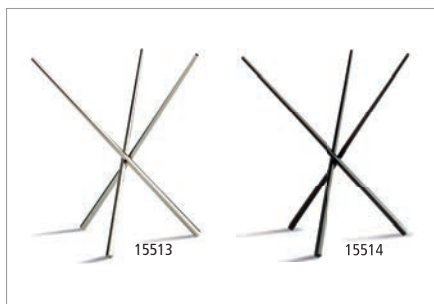

Buffetständer „ASIA PLUS“

buffet stand
soporte para buffet
présentoir buffet



	Ø cm	↑ cm	Farbe / Colour	€
15513	20,5 / 16,5	20	stainless steel	15,00
15514	20,5 / 16,5	20	■	14,00



Buffetständer / -korb „ASIA PLUS“

buffet stand / basket
soporte para buffet / cestas
présentoir buffet / corbeilles



	Ø cm	↑ cm	Farbe / Colour	€
15507	15	10,5	■	44,00
15510	15	10,5	■	44,00
	Ø cm	↑ cm	Farbe / Colour	€
15508	21	10,5	■	59,00
15511	21	10,5	■	59,00
	Ø cm	↑ cm	Farbe / Colour	€
15509	21	20	■	79,00
15512	21	20	■	79,00

NEW **ACACIA**



Buffetständer „ACACIA“

buffet stand
soporte para buffet
présentoir buffet



Akazienholz geölt / acacia wood oiled / madera de acacia aceitada / bois d'acacia huilé

	Ø cm	↑ cm	€
15620	20,0	10,5	22,00
15621	30,5	15,0	39,00
15622	30,5	20,0	42,00

www.ovarandao.pt

Frischhalte- Haube / cover / campana / cloche



	Ø cm	↑ cm	fits to	€
06520	30	22	15621, 15622	29,90

Frischhalte- Haube / cover / campana / cloche



	Ø cm	↑ cm	fits to	€
06512	30	11,5	15621, 15622	6,20



Buffetständer „ACACIA“

buffet stand
soporte para buffet
présentoir buffet



Akazienholz geölt / acacia wood oiled / madera de acacia aceitada / bois d'acacia huilé

	cm	↑ cm	GN	€
15623	53 x 16,2	20	2/4	44,00

GN Abdeckhaube / GN cover / GN cubierta/ GN cloche



	cm	↑ cm	✱ mm	GN	€
11044	53 x 16,2	10,5	3	2/4	20,00

NEW

POKE BOWL - *super trendy*

0,9 ltr.

85005



1,1 ltr.

85002



1,6 ltr.

85008

Die Farben und Formen von Lebensmittel und die Art, wie sie in den BOWLS angerichtet werden, regen unsere Sinne und unseren Appetit an. Das ist auch schon das Geheimnis der Bowl - Gerichte, die zurzeit in großer Vielfalt, mit viel Fantasie und Liebe zum Detail zubereitet werden.

The colours and shapes of food and the way they are arranged in the BOWLS stimulate our senses and our appetite. This is the secret of the bowl dishes, which are currently prepared in great variety, with a lot of imagination and attention to detail.

Los colores y las formas de los alimentos y la manera de presentación en los CUENCOS estimulan nuestros sentidos y nuestro apetito. Ese es el secreto de los platos en cuenco, que actualmente se preparan en gran variedad, con mucha imaginación y atención a los detalles.

Les couleurs et les formes des aliments et la façon dont ils sont disposés dans les BOLS stimulent nos sens et notre appétit. C'est aussi le secret des plats du bol, qui sont actuellement préparés dans une grande variété, avec beaucoup d'imagination et d'attention au détail.

0,9 ltr.



85005

Schale „POKE BOWL“

bowl
cuenco
bol

	Ø cm	↑ cm	ltr.	Farbe / Colour	€
85003	20	7	0,9	white	9,00
85005	20	7	0,9	coconut	11,00

1,1 ltr.



85000

Schale „POKE BOWL“

bowl
cuenco
bol

	Ø cm	↑ cm	ltr.	Farbe / Colour	€
85000	16	9	1,1	white	9,00
85002	16	9	1,1	coconut	11,00

1,6 ltr.



85008

Schale „POKE BOWL“

bowl
cuenco
bol

	Ø cm	↑ cm	ltr.	Farbe / Colour	€
85006	20	9	1,6	white	10,00
85008	20	9	1,6	coconut	12,00

BLUE OCEAN



Da geht die Sonne auf!
Maritime Aquatöne,
Farbverläufe und klassisches
Blau-Weiß erinnert an eine
griechische Taverne in der
Ägäis.

The sun is rising!
Maritime aqua tones,
gradients and classic blue
and white reminiscent of
a Greek tavern in the
Aegean Sea.

¡Está saliendo el sol! Los tonos marinos, los degradados de color, el clásico azul y blanco recuerdan a una taberna griega en el mar Egeo.

Le soleil se lève! Les tons maritimes, les dégradés de couleurs, le bleu et le blanc classiques, tout rappellent une taverne grecque de la mer Égée.

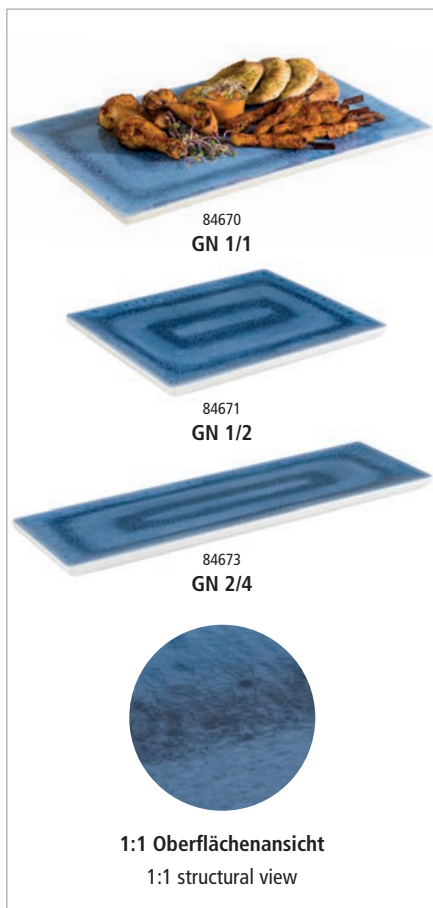

GN Tablett „BLUE OCEAN“

GN tray
GN bandeja
GN plateau

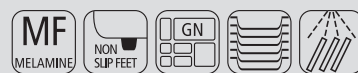

	cm	↑ cm	GN	€
84670	53,0 x 32,5	2	1/1	42,00
84671	32,5 x 26,5	2	1/2	23,00
84672	32,5 x 17,6	2	1/3	17,00
84673	53,0 x 16,2	2	2/4	24,00

GN 1/1	GN 1/2	GN 2/4	GN 1/3
	GN 1/2		GN 1/3
			GN 1/3

NEW

mit Antirutsch-
füßchen
with non-slip feet





Tablett „BLUE OCEAN“

tray
bandeja
plateau



	cm	↑ cm	€
84676	48 x 35,5	3	23,00



Schale „BLUE OCEAN“

bowl
cuenco
bol

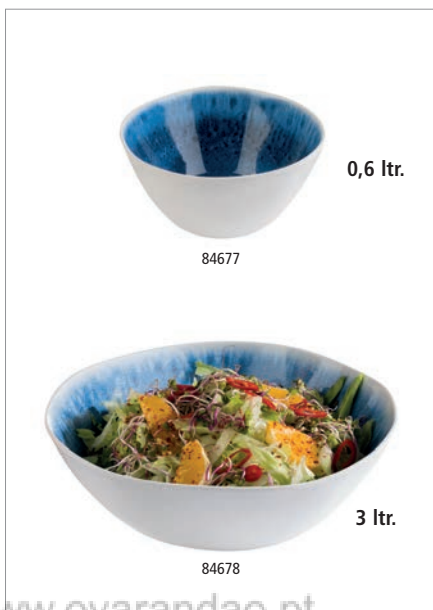

0,6 ltr.

84677

3 ltr.

84678

	Ø cm	↑ cm	ltr.	€
84677	15	7,5	0,6	6,40

	Ø cm	↑ cm	ltr.	€
84678	30,5	9	3	17,00



Teller „BLUE OCEAN“

plate
plato
assiette



84674

84675

	Ø cm	↑ cm	€
84674	21,5	2	8,90
84675	26,5	2	11,90

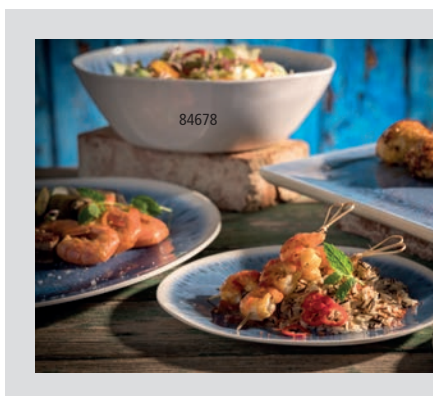

84678



84677



84678

ARABESQUE



Beim Anblick der mediterranen Melamin Serie ARABESQUE bekommt man direkt Lust auf eine Tapas-Party. Mit seinem spanischen Charme und den wundervoll ausgearbeiteten Details holen Sie sich ein Stück Spanien auf Ihr Buffet.

When looking at the Mediterranean melamine series ARABESQUE, the longing for a tapas party resurfaces. With its Spanish charm and the beautifully crafted details, you get a slice of Spain on your buffet.

Al ver la serie mediterránea de melamina ARABESQUE, se obtiene un dicho antojo por una fiesta de tapas. Con su encanto español y los detalles bellamente elaborados, obtenga una rebanada de España en su buffet.

En regardant la série de mélamine méditerranéenne ARABESQUE, vous obtenez envie de préparer une fête de tapas. Avec son charme espagnol et les détails joliment ouvrés, vous aurez une tranche d'Espagne sur votre buffet.



GN Tablett „ARABESQUE“

GN tray
GN bandeja
GN plateau



	cm	↑ cm	GN	€
84680	53,0 x 32,5	2	1/1	42,00
84681	32,5 x 26,5	2	1/2	23,00
84682	32,5 x 17,6	2	1/3	17,00
84683	53,0 x 16,2	2	2/4	24,00



Schale „ARABESQUE“

bowl
cuenco
bol

84687



84688



84689



84690

	Ø cm	↑ cm	litr.	€
84687	10,0	6,0	0,2	4,20
84688	15,5	8,0	0,8	6,40

	Ø cm	↑ cm	litr.	€
84689	20,5	5,5	1,1	9,70
84690	31,0	9,0	3,0	20,00



1:1 Oberflächenansicht

1:1 structural view



Teller „ARABESQUE“

plate
plato
assiette

	cm	↑ cm	€
84686	38 x 15,5	2	13,40



84684



84685

Teller „ARABESQUE“

plate
plato
assiette

	Ø cm	↑ cm	€
84684	21,5	2	8,40
84685	26,5	2	11,90

BAMBOO

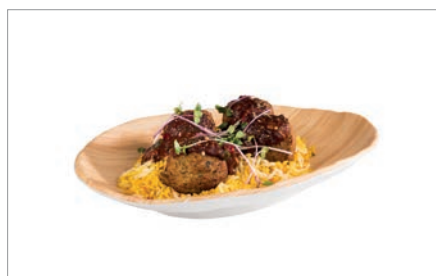

Teller „BAMBOO“

plate
plato
assiette



	cm	↑ cm	€
84809	24 x 17	3,5	7,00



Schale „BAMBOO“

bowl
cuenco
bol



	cm	↑ cm	litr.	€
84815	10,5 x 10,0	3,0	0,03	2,50
84816	17,5 x 15,5	5,5	0,2	6,40



Schale „BAMBOO“

bowl
cuenco
bol



	Ø cm	↑ cm	litr.	€
84819	30,5	8,5	2	18,00



Schale „BAMBOO“

bowl
cuenco
bol



	cm	↑ cm	litr.	€
84817	18,0 x 17,5	5,5	0,3	8,00
84818	23,0 x 22,0	7,0	0,7	13,00



Tablett „BAMBOO“

tray
bandeja
plateau



	cm	↑ cm	€
84803	10,0 x 10,0	2,0	2,40
84804	14,5 x 14,5	2,5	3,60
84805	31,0 x 10,5	2,0	7,20
84806	21,0 x 13,0	3,0	5,00
84807	24,5 x 15,5	3,0	8,00
84808	34,5 x 21,5	3,0	16,00



GN Tablett „BAMBOO“

tray
bandeja
plateau



	cm	↑ cm	GN	€
84800	53,0 x 32,5	2	1/1	42,00
84801	32,5 x 26,5	2	1/2	22,00
84802	32,5 x 17,6	2	1/3	16,00



Tablett „BAMBOO“

tray
bandeja
plateau



	cm	↑ cm	€
84811	24,5 x 15	3,5	5,00
84812	32,5 x 19	4,5	7,00



Tablett „BAMBOO“

tray
bandeja
plateau



	cm	↑ cm	€
84813	40 x 25,5	3,0	16,00
84814	53 x 34,0	3,5	28,00



Tablett „BAMBOO“

tray
bandeja
plateau



	cm	↑ cm	€
84810	34 x 13	3	9,00



GN Tablett „LOOPS“

GN tray
GN bandeja
GN plateau



	cm	↑ cm	GN	Farbe / Colour	€
85020	53,0 x 32,5	1,5	1/1		39,00
85021	32,5 x 26,5	1,5	1/2		21,00
85022	32,5 x 17,6	1,5	1/3		14,50
85023	53,0 x 16,2	1,5	2/4		23,00



Tablett/Sushi board „LOOPS“

tray
bandeja
plateau



	cm	↑ cm	€
85025	23,5 x 13,5	1,5	7,20



Teller „LOOPS“

plate
plato
assiette



	Ø cm	↑ cm	€
85027	22	2	7,40
85028	27	2	12,00



Schale „LOOPS“

bowl
cuenco
bol



	cm	↑ cm	€
85024	34 x 15,5	4	16,00



Schale „LOOPS“

bowl
cuenco
bol



	Ø cm	↑ cm	€
85026	18	3	6,20



Schale „LOOPS“

bowl
cuenco
bol



	Ø cm	↑ cm	ltr.	€
85029	20,5	6,5	0,8	14,00
85030	31,0	8,0	2,0	30,00

www.

www.ovarandao.pt

www.ovarandao.pt



Tablett „LOOPS“

tray
bandeja
plateau



	Ø cm	↑ cm	€
85031	32,0	3,5	28,00
85032	40,5	5,0	40,00



Torten- / Konditorplatte „LOOPS“

cake stand
soporte para pastel
présentoir à gâteaux



	Ø cm	↑ cm	passende Haube / suitable cover / campana adecuada / cloche appropriée	€
85033	21,5	2,5	06519 NEW	13,00
85034	30,5	3,5	06520, 06512, 06510	18,00
85035	37,5	4,0	06521 NEW	34,00

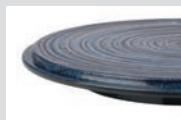

HANOI



Die ansteigenden Schalenformen erzeugen eine asiatische Marktopik und verleihen Ihrem Buffet durch die gewobene Oberflächenstruktur eine natürliche Authentizität.

The rising bowl forms create an Asian market look and give your buffet a natural authenticity through the woven surface structure.

La forma creciente de los cuencos crea un look de un mercado asiático y le dá a su buffet una autenticidad natural gracias a la estructura de la superficie tejida.

La forme croissante de bols crée un aspect visuel d'un marché asiatique et donne à votre buffet une authenticité naturelle à travers la structure de surface tissée.



Schale / Teller „HANOI“

bowl / plate
cuenco / plato
bol / assiette



	Ø cm	↑ cm	€
84725	25,5	3,0 / 6,5	12,00
84726	30,0	3,5 / 7,5	16,00
84727	35,5	4,0 / 9,0	20,00



AQUARIS



GN Tablett „AQUARIS“

GN tray
GN bandeja
GN plateau

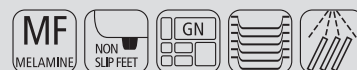

	cm	↑ cm	GN	Farbe / Colour	€
84740	53,0 x 32,5	2	1/1		42,00
84741	32,5 x 26,5	2	1/2		23,00
84742	32,5 x 17,6	2	1/3		16,80
84743	53,0 x 16,2	2	2/4		25,00

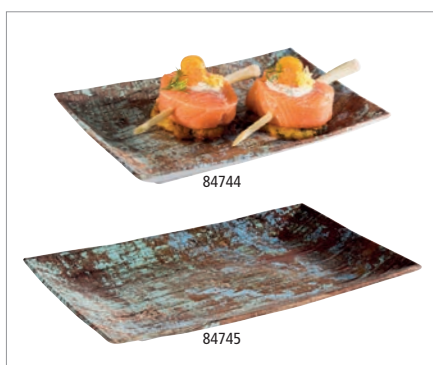

Tablett „AQUARIS“

tray
bandeja
plateau



	cm	↑ cm	Farbe / Colour	€
84744	21,0 x 13	3		7,50
84745	34,5 x 22	3		20,00



Teller „AQUARIS“

plate
plato
assiette



	Ø cm	↑ cm	Farbe / Colour	€
84746	26	3,5		11,80
84747	35	3,0		25,00

	cm	↑ cm	Farbe / Colour	€
84748	24,0 x 17	3,5		8,40
84749	40,5 x 30	4,0		25,00



Schale „COCONUT“
bowl
cuenco
bol

MELAMINE MF NON SLIP FEET

	∅ cm	↑ cm	ltr.	Farbe / Colour	€
84990	14	6,5	0,5	white/coconut	9,90
84991	24	9,5	2,2	white/coconut	29,00

1:1 Oberflächenansicht
1:1 structural view



Schale „ELEMENT LOOK“
bowl
cuenco
bol

MELAMINE MF NON SLIP FEET

	∅ cm	↑ cm	ltr.	€
84835	21,5	5,5 / 9,5	0,7	23,00
84836	26,0	7,0 / 12,5	1,45	27,50
84837	30,0	8,5 / 14,5	2,3	38,00

mit Antirutschfüßchen
with non-slip feet
con pies antideslizantes
avec pieds antidérapants



GN Tablett „IRON“

GN tray
GN bandeja
GN plateau



	cm	↑ cm	GN	€
84884	32,5 x 26,5	2	1/2	12,00
84885	26,5 x 16,2	2	1/4	7,40
84886	53,0 x 16,2	2	2/4	14,00



Schale „IRON“

GN bowl
GN cuenco
GN bol



	cm	↑ cm	GN	litr.	€
84880	32,5 x 26,5	8,5	1/2	3,5	16,00
84881	26,5 x 16,2	8,5	1/4	1,4	12,00
84882	53,0 x 16,2	8,5	2/4	3,2	19,00
84883	25,0 x 25,0	10,0	-	2,8	14,00



1:1 Oberflächenansicht
1:1 structural view

Tablett auch als Deckel
tray also lid

stapelbar
stackable



STONE ART



84511

Teller „STONE ART“
plate
plato
assiette



	Ø cm	↑ cm	€
84510	19	2	7,00
84511	25	2	11,00
84512	30	2	15,50



84509

Teller „STONE ART“
plate
plato
assiette



	Ø cm	↑ cm	ltr.	€
84509	15,5	2,5	0,15	5,20
84514	20,0	4,5	0,60	8,90



Teller „STONE ART“
plate
plato
assiette



	Ø cm	↑ cm	€
84515	24,5	3,5	12,00



Teller „STONE ART“
plate
plato
assiette



	cm	↑ cm	€
84517	33 x 32,5	3	22,00



Schale „STONE ART“

bowl
cuenco
bol

	Ø cm	↑ cm	ltr.	€
84523	8	3	0,07	2,30



Schale „STONE ART“

bowl
cuenco
bol

	Ø cm	↑ cm	ltr.	€
84524	12	6	0,3	4,50



Schale „STONE ART“

bowl
cuenco
bol

	Ø cm	↑ cm	ltr.	€
84525	15	7,5	0,6	5,80



Schale „STONE ART“

bowl
cuenco
bol

	cm	↑ cm	ltr.	€
84526	23 x 19	6,5	0,6	10,50



Schale „STONE ART“

bowl
cuenco
bol

	cm	↑ cm	ltr.	€
84528	28,5 x 21	7,5	1,2	17,00



84529

Schale „STONE ART“

bowl
cuenco
bol

	cm	↑ cm	ltr.	€
84529	19 x 19	6,0	0,5	11,50
84530	24 x 24	6,5	1,1	16,00



GN Tablett „STONE ART“

GN tray
GN bandeja
GN plateau

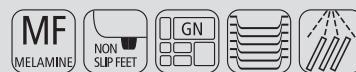

	cm	↑ cm	GN	€
84519	53,0 x 32,5	1,5	1/1	42,00
84520	32,5 x 26,5	1,5	1/2	23,00
84522	53,0 x 16,2	1,5	2/4	24,00
84521	32,5 x 17,6	1,5	1/3	17,00



mit Antirutschfüßchen
with non-slip feet
con pies antideslizantes
avec pieds antidérapants



GN Abdeckhaube

GN cover
GN cubierta
GN cloche



passend für GN Tablett, glasklarer Kunststoff, nahezu unzerbrechlich
suitable for GN trays, clear plastic, nearly unbreakable
apto para bandejas GN, plástico transparente, muy resistente a la rotura
pour bacs et plateaux GN, plastique transparent, très résistant à la casse

	cm	↑ cm	∕ mm	GN	€
11043	32,5 x 17,6	10,5	3	1/3	15,00
11044	53,0 x 16,2	10,5	3	2/4	20,00

	cm	↑ cm	∕ mm	GN	€
11041	32,5 x 26,5	9,5	3	1/2	20,00
11042	53,0 x 32,5	9,5	3	1/1	28,00

AIKO



Schale „AIKO“

bowl
cuenco
bol



Steinoptik
appearance stoneware
su aspecto recuerda al gres
l'aspect de la mélamine rapelle le grès

	cm	↑ cm	ltr.	Farbe / Colour	€
84327	26,5 x 19,5	6	0,9	■	9,90



84331

Schale „AIKO“

bowl
cuenco
bol



Steinoptik
appearance stoneware
su aspecto recuerda al gres
l'aspect de la mélamine rapelle le grès

	Ø cm	↑ cm	ltr.	Farbe / Colour	€
84329	8,0	4	0,07	■	3,20
84331	11,5	6	0,20	■	4,20



84334

84337

Schale „AIKO“

bowl
cuenco
bol



Steinoptik
appearance stoneware
su aspecto recuerda al gres
l'aspect de la mélamine rapelle le grès

	Ø cm	↑ cm	ltr.	Farbe / Colour	€
84334	16,0	7	0,6	■	6,80
84336	20,5	8	1,2	■	10,50
	Ø cm	↑ cm	ltr.	Farbe / Colour	€
84335	16,0	7	0,6	■	6,80
84337	20,5	8	1,2	■	10,50



Betonoberflächen auf dem Buffet für den Kontakt mit Lebensmitteln? ELEMENT macht es möglich. Bestens geeignet im modernen und urbanen Ausstattungsumfeld.

Concrete surfaces on the buffet for food contact? ELEMENT makes it possible. Ideally suited for modern and urban environments.

¿Superficies de hormigón en el buffet y tener contacto con alimentos? ELEMENT lo hace posible. Ideal para ambientes modernos y urbanos.

Des surfaces en béton sur le buffet et destinées au contact alimentaire? ELEMENT le rend possible. Idéal pour les environnements modernes et urbains.



Schale „ELEMENT“
bowl
cuenco
bol

	cm	↑ cm	ltr.	€
84825	∅ 8,0	2,0	0,01	1,30
84826	10,5 x 10,0	3,0	0,02	2,80
84820	9,0 x 7,0	3,0	0,03	2,80
84821	10,5 x 10,5	3,0	0,04	3,20
84827	17,5 x 15,5	5,5	0,18	6,40



Tablett „ELEMENT“
tray
bandeja
plateau

	cm	↑ cm	€
84822	20 x 9,5	2,5	6,40



Tablett „ELEMENT“
tray
bandeja
plateau

	cm	↑ cm	€
84824	31 x 10,5	1,5	8,40



Tablett „ELEMENT“

tray
bandeja
plateau



	cm	↑ cm	€
84823	22,5 x 15	3	9,60

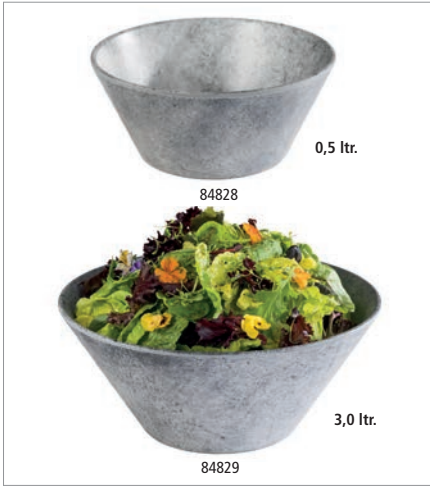

Schale „ELEMENT“

bowl
cuenco
bol



	Ø cm	↑ cm	ltr.	€
84828	16	7	0,5	7,60
84829	28	12	3,0	22,00



Schale „ELEMENT“

bowl
cuenco
bol



	cm	↑ cm	ltr.	€
84830	19 x 19	9	1,5	22,00
84831	25 x 25	12	3,8	33,00



GN Tablett „ELEMENT“

GN tray
GN bandeja
GN plateau



	cm	↑ cm	GN	€
84400	53,0 x 32,5	3,5	1/1	36,00
84401	32,5 x 26,5	3,5	1/2	20,00
84402	32,5 x 17,5	3,5	1/3	14,80
84403	26,5 x 16,2	3,5	1/4	11,60
84404	53,0 x 16,2	3,5	2/4	22,00

CROCKER



84571

84581

84575

84567

Servier- und Buffetartikel in Tonoptik, brauner Rand. Die Oberfläche ist innen und außen fein-matt, fühlt sich an wie Ton.

Serving and buffet items, an imitation of clay, with a brown border. The surface is inside and outside fine-matt. Feels like real clay.

Artículos de servicio y buffet, imitación barro y con borde marrón. La superficie de dentro y de fuera es de deslustre fino. Parece barro natural.

Pièces de service et pour le buffet imitation argile avec bord marron. La surface est à l'intérieur et à l'extérieur bien-matte.



Teller „CROCKER“

plate
plato
assiette



	cm	↑ cm	Farbe / Colour	€
84567	14 x 13	2,5		3,20
84568	14 x 13	2,5		3,20



Teller „CROCKER“

plate
plato
assiette



	Ø cm	↑ cm	ltr.	Farbe / Colour	€
84575	20,5	3	0,50		6,20
84576	20,5	3	0,50		6,20



Schale „CROCKER“

bowl
cuenco
bol

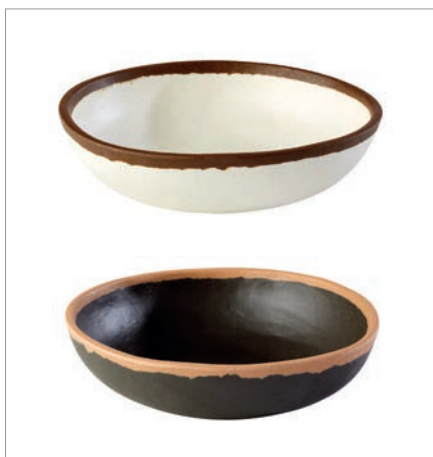

	Ø cm	↑ cm	ltr.	Farbe / Colour	€
84573	16,5	4	0,50		5,60
84574	16,5	4	0,50		5,60



Schale „CROCKER“

bowl
cuenco
bol



84569
Ø 12,5 cm

84572
Ø 16,0 cm

84577
Ø 21,0 cm

	Ø cm	↑ cm	ltr.	Farbe / Colour	€
84569	12,5	6	0,37		3,40
84570	12,5	6	0,37		3,40
84571	16,0	7	0,70		5,80
84572	16,0	7	0,70		5,80
84577	21,0	8	1,45		10,00
84578	21,0	8	1,45		10,00



Blattschale „CROCKER“

leaf
fuente en forma de hoja
plateau feuille



84579

84581

	cm	↑ cm	ltr.	Farbe / Colour	€
84579	30,5 x 10	7,5	0,17		6,40
84580	30,5 x 10	7,5	0,17		6,40
84581	42 x 14	9,5	0,65		15,00
84582	42 x 14	9,5	0,65		15,00



FRIDA

FRIDA'S BREAKFAST



NEW FRIDA

FRIDA'S HEALTHY BUFFET

Buffet & Tableware
Melamin



www.ovarandao.pt

www.ovarandao.pt

www.ovarandao.pt





Schale „FRIDA LOCK“

bowl
cuenco
bol



Schalen lassen sich durch Drehmechanismus mit dem Ständer fest verbinden

bowls can be firmly connected to the stand by a turning mechanism

los cuencos se pueden conectar firmemente al soporte mediante un mecanismo giratorio

les bols peuvent être solidement reliés au présentoir au moyen d'un mécanisme rotatif

	Ø cm	↑ cm	ltr.	Farbe / Colour	€
84920	21,5	7/8,5	1,0		29,00
84921	21,5	7/8,5	1,0		29,00
84922	25,0	8/11	1,6		36,00
84923	25,0	8/11	1,6		36,00
84924	28,5	10/14	2,6		39,00
84925	28,5	10/14	2,6		39,00



Haube

cover
campana
cloche



	Ø cm	↑ cm	fits to	€
06519 NEW	21	17	84941, 84942	24,00
06520	30	22	84943, 84944	29,90
06521 NEW	36	27	84945, 84946	56,00



Tablett / Platte „FRIDA LOCK“

tray
bandeja
plateau



Tabletts lassen sich durch Drehmechanismus mit dem Ständer fest verbinden
trays can be firmly connected to the stand by a turning mechanism
las bandejas se pueden conectar firmemente al soporte mediante un mecanismo giratorio
les plateaux peuvent être solidement reliés au présentoir au moyen d'un mécanisme rotatif

	Ø cm	↑ cm	Farbe / Colour	€
84941	22,5	1,5/2,5		16,90
84942	22,5	1,5/2,5		16,90
84943	31,5	1,5/2,5		26,00
84944	31,5	1,5/2,5		26,00
84945	38,0	1,5/2,5		39,00
84946	38,0	1,5/2,5		39,00



Ständer „FRIDA LOCK“

stand
soporte
présentoir



	Ø cm	↑ cm	Farbe / Colour	€
84926	16,5	8		8,40
84927	16,5	8		8,40



Ständer „FRIDA LOCK“

stand
soporte
présentoir



	Ø cm	↑ cm	Farbe / Colour	€
84928	16,5	12		14,40
84929	16,5	12		14,40



FRIDA



Auf der kurzen und der langen Seite aufstellbar!

Can stay on the short or long side!

Se puede colocar por la parte corta o larga!

Se peut installer sur le côté court ou long!

GN Buffetständer

GN buffet stand
GN soporte para buffet
GN présentoir buffet



	cm	GN	Farbe / Colour	€
15504	53,0 x 32,5 / 53,0 x 16,2	1/1 / 2/4	■	19,00
15505	32,5 x 26,5 / 26,5 x 16,2	1/2 / 1/4	■	12,00



GN Tablett „FRIDA“

GN tray
GN bandeja
GN plateau

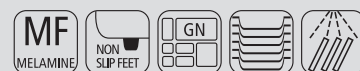

	cm	↑ cm	GN	€
84601	53,0 x 32,5	2	1/1	42,00
84602	32,5 x 26,5	2	1/2	22,00
84603	26,5 x 16,2	2	1/4	14,00
84604	53,0 x 16,2	2	2/4	24,00



mit Antirutschfüßchen
with non-slip feet
con pies antideslizantes
avec pieds antidérapants

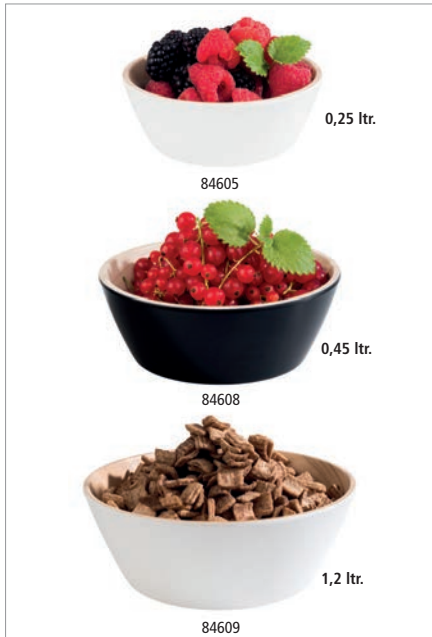

Schale „FRIDA“
bowl
cuenco
bol



	Ø cm	↑ cm	ltr.	Farbe / Colour	€
84605	12,5	4,5	0,25		9,40
84606	12,5	4,5	0,25		9,40
84607	15,0	5,5	0,44		15,40
84608	15,0	5,5	0,44		15,40
84609	20,0	7,5	1,20		23,00
84610	20,0	7,5	1,20		23,00



Schale „FRIDA“
bowl
cuenco
bol



	Ø cm	↑ cm	ltr.	Farbe / Colour	€
84611	22,0	10,5	2,2		24,80
84612	22,0	10,5	2,2		24,80
84613	26,5	10,5	3,4		31,00
84614	26,5	10,5	3,4		31,00



mit Antirutschfüßchen
with non-slip feet
con pies antideslizantes
avec pieds antidérapants



Tablett „FRIDA“
tray
bandeja
plateau



	cm	↑ cm	Farbe / Colour	€
84650	21,5 x 10,0	2,0		6,20
84651	21,5 x 10,0	2,0		6,20
84652	27,0 x 12,0	2,5		9,40
84653	27,0 x 12,0	2,5		9,40
84654	36,0 x 16,5	3,0		14,90
84655	36,0 x 16,5	3,0		14,90



Schale „FRIDA“
bowl
cuenco
bol



	cm	↑ cm	Farbe / Colour	€
84615	32 x 25	3,5		27,00
84616	32 x 25	3,5		27,00



Schale „FRIDA“

bowl
cuenco
bol

	Ø cm	↑ cm	ltr.	Farbe / Colour	€
84930	8,5	3,5	0,1		3,20
84931	8,5	3,5	0,1		3,20
84932	21,5	7,5	1,8		22,00
84933	21,5	7,5	1,8		22,00
84934	30,0	9,5	4,7		36,00
84935	30,0	9,5	4,7		36,00



Schale „FRIDA“

bowl
cuenco
bol

	cm	↑ cm	ltr.	Farbe / Colour	€
84936	12,5 x 12,5	4,5	0,37		6,40
84937	12,5 x 12,5	4,5	0,37		6,40

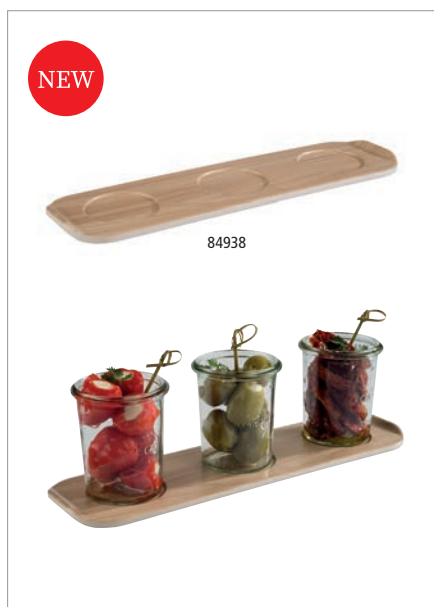

Tablett „FRIDA“

tray
bandeja
plateau

mit 3 Absätzen, Ø 5,4 cm
with 3 holes, Ø 5,4 cm
con 3 agujeros, Ø 5,4 cm
avec 3 trous, Ø 5,4 cm

	cm	↑ cm	Farbe / Colour	€
84938	30 x 8,5	1		8,60

Anwendungsbeispiel mit Weck-Glas Nr. 82312
example of use with Weck-glasses no. 82312

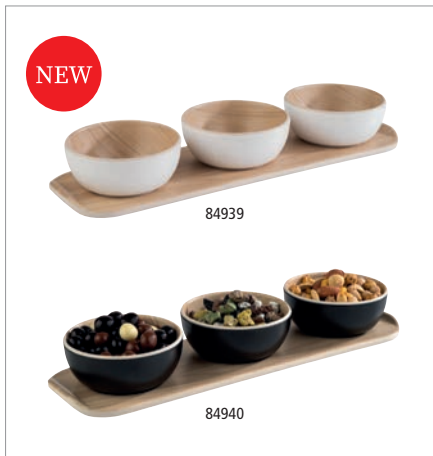

Servierset „FRIDA“, 4-tlg.

serving set, 4 pcs. set
set de servicio, set de 4
set de service, set de 4



4-teiliges Set, bestehend aus 1 Tablett mit 3 Schalen

4 pcs set, consisting of 1 tray with 3 bowls
set de 4, compuesto por 1 bandeja con 3 cuencos
set de 4, composé d'un plateau avec 3 bols

	cm	↑ cm	Farbe / Colour	€
84939	30 x 8,5	4,5		18,00
84940	30 x 8,5	4,5		18,00



GN 1/9 Schale „FRIDA“

GN 1/9 bowl
GN 1/9 cuenco
GN 1/9 bol



	Ø cm	↑ cm	GN	ltr.	Farbe / Colour	€
84555	17,6 x 10,8	5,5	1/9	0,5		8,40
84556	17,6 x 10,8	5,5	1/9	0,5		8,40



GN 1/6 Schale „FRIDA“

GN 1/6 bowl
GN 1/6 cuenco
GN 1/6 bol



	Ø cm	↑ cm	GN	ltr.	Farbe / Colour	€
84583	17,6 x 16,2	7,5	1/6	1,0		13,00
84584	17,6 x 16,2	7,5	1/6	1,0		13,00



GN 1/4 + 2/4 Schale „FRIDA“

GN 1/4 + 2/4 bowl
GN 1/4 + 2/4 cuenco
GN 1/4 + 2/4 bol



	Ø cm	↑ cm	GN	ltr.	Farbe / Colour	€
84586	26,5 x 16,2	7,5	1/4	1,8		20,00
84587	26,5 x 16,2	7,5	1/4	1,8		20,00
	Ø cm	↑ cm	GN	ltr.	Farbe / Colour	€
84564	53 x 16,2	7,5	2/4	3,65		26,00
84565	53 x 16,2	7,5	2/4	3,65		26,00



GN 1/2 Schale

GN 1/2 bowl
GN 1/2 cuenco
GN 1/2 bol



	Ø cm	↑ cm	GN	ltr.	Farbe / Colour	€
84589	32,5 x 26,5	7,5	1/2	4,0		27,00
84590	32,5 x 26,5	7,5	1/2	4,0		27,00



Schale „FRIDA“

bowl
cuenco
bol



	cm	↑ cm	ltr.	Farbe / Colour	€
84558	16,5 x 16,5	5,5	0,85		9,20
84559	16,5 x 16,5	5,5	0,85		9,20



Schale „FRIDA“

bowl
cuenco
bol



	cm	↑ cm	ltr.	Farbe / Colour	€
84561	25 x 25	7,5	2,65		17,40
84562	25 x 25	7,5	2,65		17,40



GN 1/4 Tablett „FRIDA“

GN 1/4 tray
GN 1/4 bandeja
GN 1/4 plateau



	cm	↑ cm	ltr.	Farbe / Colour	€
84595	26,5 x 16,2	3	1/4		12,60
84596	26,5 x 16,2	3	1/4		12,60



Tablett „FRIDA“

tray
bandeja
plateau



	cm	↑ cm	ltr.	Farbe / Colour	€
84598	35,5 x 26,0	3			19,40
84599	35,5 x 26,0	3			19,40



Schale „FRIDA“

bowl
cuenco
bol



	cm	↑ cm	ltr.	Farbe / Colour	€
84592	25 x 25	12	3,5		27,00
84593	25 x 25	12	3,5		27,00



Deckel „PURE“ mit Löffelaussparung / cover with notched for spoons / tapa con espacio para la cuchara / couvercle avec encoche pour la louche

	cm	↑ cm	fits to	€
83601	25 x 25	1,5	84561, 84562, 84592, 84593, 84594	10,50



Schale „FRIDA STONE“

bowl
cuenco
bol



	cm	↑ cm	ltr.	Farbe / Colour	€
84594	25 x 25	12	3,5		27,00

**Schale „FRIDA STONE“**bowl
cuenco
bol

	Ø cm	↑ cm	GN	Farbe / Colour	€
84560	16,5 x 16,5	5,5	0,85	■	9,20
84563	25,0 x 25,0	7,5	2,65	■	17,00

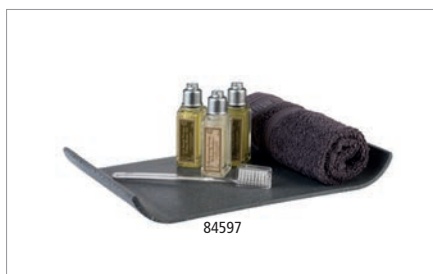
**Tablett „FRIDA STONE“**tray
bandeja
plateau

	Ø cm	↑ cm	GN	Farbe / Colour	€
84597	26,5 x 16,2	3	1/4	■	12,60
84600	35,5 x 26,0	3	-	■	19,40

**GN 1/9 Schale „FRIDA STONE“**GN 1/9 bowl
GN 1/9 cuenco
GN 1/9 bol

	cm	↑ cm	GN	litr.	Farbe / Colour	€
84557	17,6 x 10,8	5,5	1/9	0,5	■	8,40

**GN 1/6 Schale „FRIDA STONE“**GN 1/6 bowl
GN 1/6 cuenco
GN 1/6 bol

	cm	↑ cm	GN	litr.	Farbe / Colour	€
84585	17,6 x 16,2	7,5	1/6	1,0	■	13,00

**GN 1/4 Schale**GN 1/4 bowl
GN 1/4 cuenco
GN 1/4 bol

	cm	↑ cm	GN	litr.	Farbe / Colour	€
84588	26,5 x 16,2	7,5	1/4	1,8	■	19,90

**GN 1/2 Schale „FRIDA STONE“**GN 1/2 bowl
GN 1/2 cuenco
GN 1/2 bol

	cm	↑ cm	GN	litr.	Farbe / Colour	€
84591	32,5 x 26,5	7,5	1/2	4,0	■	27,00

**GN 2/4 Schale „FRIDA STONE“**GN 2/4 bowl
GN 2/4 cuenco
GN 2/4 bol

	cm	↑ cm	GN	litr.	Farbe / Colour	€
84566	53 x 16,2	7,5	2/4	3,65	■	26,00

FLOWER POT



Schale „FLOWER POT“

bowl
cuenco
bol



	Ø cm	↑ cm	ltr.	Farbe / Colour	€
84470	6	3,5	0,04		1,30
84471	6	3,5	0,04		1,30
84472	6	3,5	0,04		1,30

	Ø cm	↑ cm	ltr.	Farbe / Colour	€
84473	9	8,5	0,30		4,20
84474	9	8,5	0,30		4,20
84475	9	8,5	0,30		4,20

	Ø cm	↑ cm	ltr.	Farbe / Colour	€
84476	12	3,5	0,20		3,40
84478	12	3,5	0,20		3,40

	Ø cm	↑ cm	ltr.	Farbe / Colour	€
84479	13	15	1,00		12,00
84481	13	15	1,00		12,00

	Ø cm	↑ cm	ltr.	Farbe / Colour	€
84482	20	9	1,80		14,00
84484	20	9	1,80		14,00

Deckel „UNIVERSAL“ mit Löffelaussparung / cover with notched for spoons
tapa con espacio para la cuchara / couvercle avec encoche pour la cuillère

	Ø cm	↑ cm	fits to	€
15341	20	1,5	84482, 84483, 84484	5,00



GLAMOUR

84377

84381



Schale „GLAMOUR“
bowl
cuenco
bol



	Ø cm	↑ cm	ltr.	€
84365	8	3	0,05	1,50



Schale „GLAMOUR“
bowl
cuenco
bol



	Ø cm	↑ cm	ltr.	€
84366	12	5	0,25	2,00



Schale „GLAMOUR“
bowl
cuenco
bol



	Ø cm	↑ cm	ltr.	€
84367	15	8	0,70	4,40

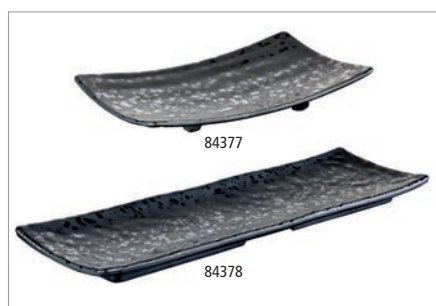

Tablett „GLAMOUR“
tray
bandeja
plateau



	cm	↑ cm	€
84377	22 x 12	3,0	3,20
84378	37 x 11	2,5	9,00



Tablett „GLAMOUR“
tray
bandeja
plateau



	cm	↑ cm	€
84380	25,0 x 15,5	1,5	2,90
84381	30,5 x 19,0	1,5	4,40



Tablett „GLAMOUR“
tray
bandeja
plateau



	cm	↑ cm	€
84379	30 x 11	3	4,90

OAK



Tablett „OAK“

tray
bandeja
plateau



	cm	↑ cm	→ cm	€
84431	17,5 x 14,5	1,5	Griff / handle 6,5	7,00
84432	22,0 x 12,0	2,0	Griff / handle 11,0	8,00



Tablett „OAK“

tray
bandeja
plateau



	cm	↑ cm	€
84433	20 x 20	2,5	8,00



Schale „OAK“

bowl
cuenco
bol



	cm	↑ cm	€
84434	11,5 x 7,0	2,5	3,80
84435	25,0 x 6,5	3,5	6,20



GN Tablett „OAK“

GN tray
GN bandeja
GN plateau



Eichenoptik
oak wood effect
imitación madera de roble
imitation chêne

	cm	↑ cm	GN	€
84720	53,0 x 32,5	1	1/1	38,00
84721	32,5 x 26,5	1	1/2	20,00
84722	32,5 x 17,6	1	1/3	14,00
84723	26,5 x 16,2	1	1/4	11,00
84724	53,0 x 16,2	1	2/4	22,00

OAK



Die Melaminplatten (Holzoptik Eiche) haben eine leichte Struktur und wirken optisch wie aus Holz gefertigt.

The melamine trays (superb oak wood effect) have a lightweight structure and look visually as made of wood.

Las bandejas de melamina (imitación madera de roble) tienen una estructura ligera y parecen estar hechas de madera.

Les plateaux de mélamine (imitation bois de chêne) ont une structure légère et donnent une impression visuelle de bois.



Tablett „OAK“

tray
bandeja
plateau



	Ø cm	↑ cm	→ cm	€
84177	30	1,5	Griff / handle 12	21,00



Tablett „OAK“

tray
bandeja
plateau



	cm	↑ cm	→ cm	€
84178	40 x 20	1,5	Griff / handle 13	26,00



Tablett „OAK“

tray
bandeja
plateau



	cm	↑ cm	→ cm	€
84179	48 x 20	1,5	Griff / handle 13	32,00

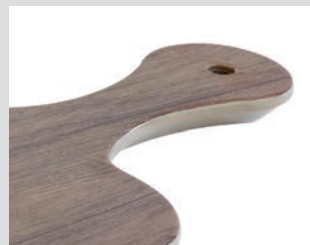

OAK LIGHT



Die Melaminplatten (Holzoptik Eiche hell) haben eine leichte Struktur und wirken optisch wie aus Holz gefertigt.

The melamine trays (wood look light oak) have a lightweight structure and look visually as made of wood.

Las bandejas de melamina (imitación madera de roble claro) tienen una estructura ligera y parecen estar hechas de madera.

Les plateaux de mélamine (imitation bois de chêne clair) ont une structure légère et donnent une impression visuelle de bois.



Tablett „OAK LIGHT“
tray
bandeja
plateau



	∅ cm	↑ cm	€
84262	35	3	25,00
84263	44	3	38,00



Tablett „OAK LIGHT“
tray
bandeja
plateau



	cm	↑ cm	€
84264	44 x 25	1,5	20,00



Tablett „OAK LIGHT“
tray
bandeja
plateau



	cm	↑ cm	€
84265	65 x 26	3	30,00

OAK LIGHT GN



HOLZ OPTIK



84205
GN 1/1



84206
GN 1/2



84207
GN 1/3

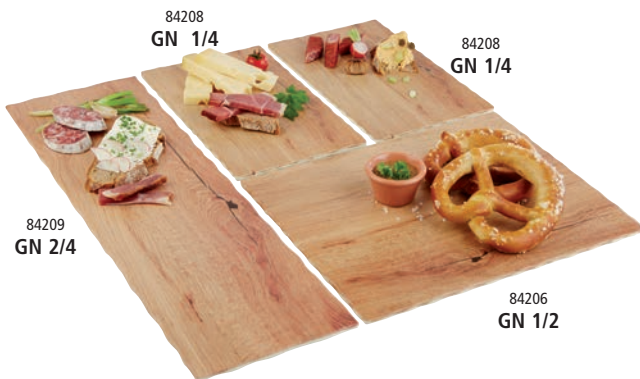

84208
GN 1/4

84208
GN 1/4

84209
GN 2/4

84206
GN 1/2

GN Tablett „OAK LIGHT“

GN tray
GN bandeja
GN plateau



	cm	↑ cm	GN	€
84205	53,0 x 32,5	1,5	1/1	35,00
84206	32,5 x 26,5	1,5	1/2	18,40
84207	32,5 x 17,6	1,5	1/3	13,00
84208	26,5 x 16,2	1,5	1/4	10,50
84209	53,0 x 16,2	1,5	2/4	21,00



Holzoptik Eiche hell

wood look oak light
aspecto madera, roble claro
aspect bois chêne clair



mit Antirutschfüßchen

with non-slip feet
con pies antideslizantes
avec pieds antidérapants

GN 1/1	GN 1/2	GN 1/4	GN 2/4
	GN 1/2	GN 1/4	
GN 1/3	GN 1/3	GN 1/3	

TIMBER



Die Melaminplatten (Holzoptik Fichte) haben eine leichte Struktur und wirken optisch wie aus Holz gefertigt.

The melamine trays (superb spruce wood effect - timber) have a lightweight structure and look visually as made of wood.

Las bandejas de melamina (imitación madera de picea) tienen una estructura ligera y parecen estar hechas de madera.

Les plateaux de mélamine (imitation bois d'épicéa) ont une structure légère et donnent une impression visuelle de bois.



Schale „TIMBER“

bowl
cuenco
bol



	cm	↑ cm	ltr.	€
84893	28 X 25	7,5	1,5	24,00
84894	43 X 24	7,5	2,0	39,00



Schale „TIMBER“

bowl
cuenco
bol



	Ø cm	↑ cm	ltr.	€
84895	25,5	15	3,0	36,00



Teller „TIMBER“

plate
plato
assiette



	Ø cm	↑ cm	€
84890	15	1,5	4,00



Teller „TIMBER“

plate
plato
assiette



	Ø cm	↑ cm	€
84891	21,5	2,5	8,00
84892	27,5	3,0	12,00



Tablett „TIMBER“

tray
bandeja
plateau



	Ø cm	↑ cm	€
84266	35	3	25,00
84267	44	3	38,00



Tablett „TIMBER“

tray
bandeja
plateau



	cm	↑ cm	€
84268	44 x 25	1,5	20,00



Tablett „TIMBER“

tray
bandeja
plateau



	cm	↑ cm	€
84269	65 x 26	3	30,00



Tablett „TIMBER“

tray
bandeja
plateau



	cm	↑ cm	€
84256	70 x 26	3	59,00

SLATE



Die schwarzen Melaminplatten überzeugen mit ihrem edlen und schlichten Schieferlook und einer rauhen Oberfläche.

The black melamine trays convince with their noble and simple slate look and a rough surface.

Las bandejas de melamina negras convencen por su aspecto de pizarra elegante y discreto y una superficie áspera.

Les plateaux en mélamine noirs convainquent grâce au aspect de l'ardoise élégant et discret et une surface rugueuse.



GN Tablett „SLATE“

GN tray
GN bandeja
GN plateau



	cm	↑ cm	GN	€
83955	53,0 x 32,5	1	1/1	39,00
83956	32,5 x 26,5	1	1/2	21,00
83957	32,5 x 17,6	1	1/3	14,50
83958	26,5 x 16,2	1	1/4	11,60
83971	53,0 x 16,2	1	2/4	23,00



GN Tablett „SLATE“

GN tray
GN bandeja
GN plateau



	cm	↑ cm	GN	€
83981	53 x 32,5	1,5	1/1	40,00



GN Tablett „SLATE“

GN tray
GN bandeja
GN plateau



massive Metallgriffe verchromt inkl. fest verschraubten 4 cm Distanzstücken
chrome plated handles, incl. mounted 4 cm distance pillars
asas cromadas, incluye distanciadores a 4 cm
poignées chromées, distance approx. 4 cm

	cm	↑ cm	GN	€
83980	53 x 32,5	6	1/1	47,00



Tablett „SLATE“

tray
bandeja
plateau



	cm	↑ cm	€
84960	28 x 17,5	2,5	12,00



Ø 2,5 cm



Tablett „SLATE“

tray
bandeja
plateau



	Ø cm	↑ cm	€
84961	28	2,5	12,00



Ø 2,5 cm



Tablett „SLATE“

tray
bandeja
plateau



	Ø cm	↑ cm	€
83992	30	1	18,90
83994	40	1	30,00

83994



Schale „SLATE“

bowl
cuenco
bol



	cm	↑ cm	litr.	€
84244	19 x 19	9	1,5	20,00
84245	25 x 25	12	3,8	34,00

Deckel „PURE“ mit Löffelaussparung / cover with notched for spoons
tapa con espacio para la cuchara / couvercle avec encoche pour la louche

	cm	↑ cm	fits to	€
83600	19 x 19	1,5	84244	8,00
83601	25 x 25	1,5	84245	10,50

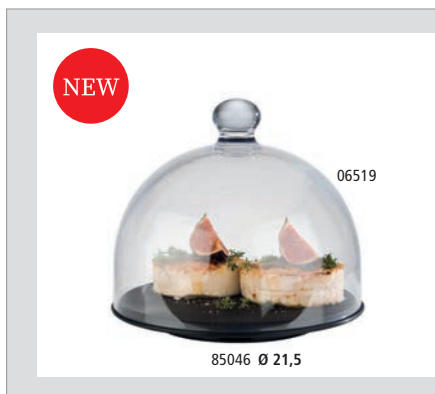

Torten- / Konditorplatte „SLATE“

cake stand
soporte para pastel
présentoir à gâteaux



Rand fixiert die Haube, mit Antirutsch-Füßchen

carved edge fixes the cover, with non-slip feet

ranura para fijar bien la campana, con pies antideslizantes

bord rainuré pour maintenir ferme la cloche, avec pieds antidérapants

	Ø cm	↑ cm		€
85046	21,5	2,5		13,00
85047	30,5	3,5		18,00
85048	37,5	4		34,00

Frischhalte- Haube / cover / campana / cloche



	Ø cm	↑ cm	fits to	€
06519 NEW	21	17	85046	24,00
06520	30	22	85047	29,90
06521 NEW	36	27	85048	56,00



Tablett „SLATE“

tray
bandeja
plateau



	Ø cm	↑ cm	→ cm		€
84241	23,0	1,5	10	Ø Loch 2 cm	12,80
84242	33,5	1,5	14	Ø Loch 2,5 cm	25,00

Frischhalte- Haube / cover / campana / cloche



	Ø cm	↑ cm	fits to	€
06520	30,0	22	84242, 84177, 83891, 83890, 83884, 15303, 998, 975, 469, 468, 463, 462 46,	29,90
15351	20,5	10	84241	9,90

SLATE ROCK



www.ovarandao.pt

www.ovarandao.pt



Tablett „SLATE-ROCK“

tray
bandeja
plateau



Die schwarzen Melaminplatten überzeugen mit ihrem Schieferlook
The black melamine trays convince with their slate look
Las bandejas de melamina negras convencen por su aspecto de pizarra
Les plateaux en mélamine noirs convainquent grâce au aspect de l'ardoise

	∅ cm	↑ cm	→ cm	€
84257	30	1,5	Griff 12	20,00
	cm	↑ cm	→ cm	€
84258	40 x 20	1,5	Griff 13	25,00
84259	48 x 20	1,5	Griff 13	30,00

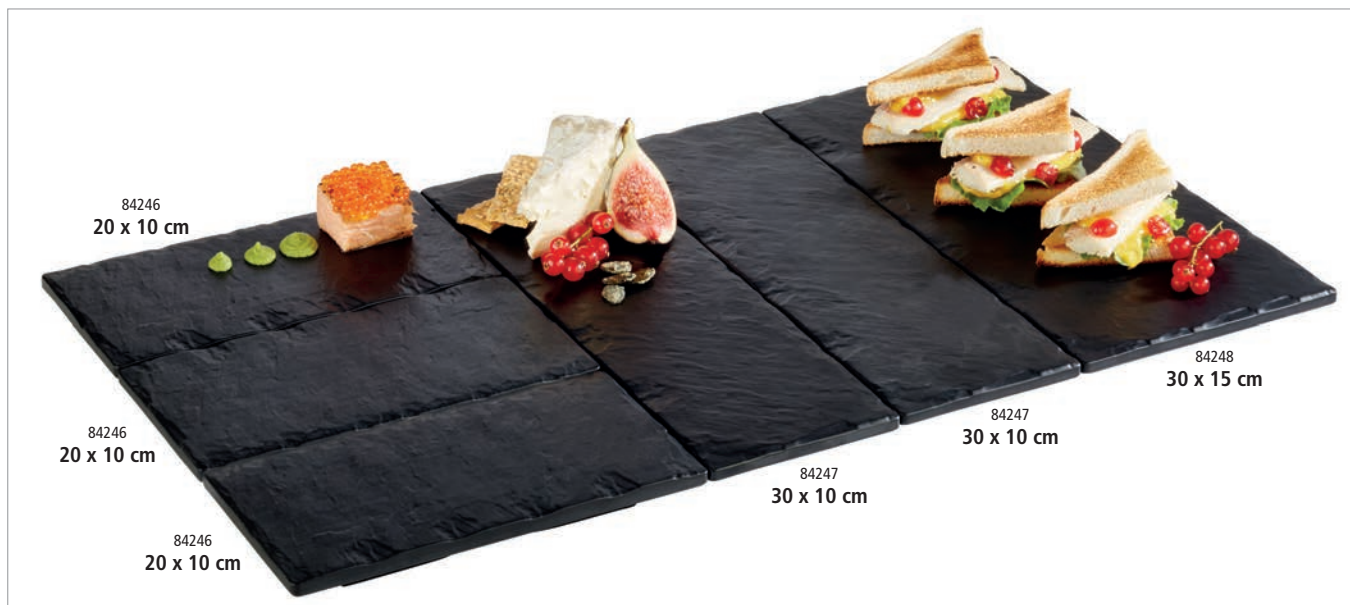

Tablett „SLATE-ROCK“

tray
bandeja
plateau



Die schwarzen Melaminplatten überzeugen mit ihrem Schieferlook

The black melamine trays convince with their slate look

Las bandejas de melamina negras convencen por su aspecto de pizarra

Les plateaux en mélamine noirs convainquent grâce au aspect de l'ardoise

	cm	↑ cm	€
84246	20 x 10	2	6,20
84247	30 x 10	2	8,40
84248	30 x 15	2	10,60



1:1 Oberflächenansicht

1:1 structural view

GN Tablett „ROCKFACE“

GN tray
GN bandeja
GN plateau



die Melaminplatten (Steinoptik) haben eine leicht wellige Oberfläche und wirken optisch wie ein Naturstein

the melamine trays (imitation of stone) have a slightly wavy surface and look visually as made of natural stone

las bandejas de melamine (imitación piedra) tienen una superficie ligeramente ondulada y parecen estar hechas de piedra natural

les plateaux de mélamine (imitation pierre) ont une surface légèrement ondulée et donnent une impression visuelle de pierre naturelle

	cm	↑ cm	GN	€
84770	53,0 x 32,5	1,5	1/1	36,00
84771	32,5 x 26,5	1,5	1/2	19,50
84772	32,5 x 17,6	1,5	1/3	14,00
84773	26,5 x 16,2	1,5	1/4	11,20
84774	53,0 x 16,2	1,5	2/4	22,00

**GN Tablett „ZERO“**

GN tray
GN bandeja
GN plateau



glatte, hochglänzende Oberfläche
smooth and shiny surface
superficie lisa con acabado brillante
surface lisse et finition brillante

	cm	↑ cm	GN	Farbe / Colour	€
84185	53,0 x 32,5	1,5	1/1		34,00
84186	32,5 x 26,5	1,5	1/2		18,20
84187	32,5 x 17,6	1,5	1/3		12,80
84188	26,5 x 16,2	1,5	1/4		10,40
84189	53,0 x 16,2	1,5	2/4		20,00
84195	53,0 x 32,5	1,5	1/1		34,00
84196	32,5 x 26,5	1,5	1/2		18,20
84197	32,5 x 17,6	1,5	1/3		12,80
84198	26,5 x 16,2	1,5	1/4		10,40
84199	53,0 x 16,2	1,5	2/4		20,00

**GN Tablett „DRIFTWOOD“**

GN tray
GN bandeja
GN plateau



die Melaminplatten (Holzoptik) haben eine leicht wellige Oberfläche und wirken optisch wie aus Holz gefertigt
the melamine trays (wood look) have a slightly wavy surface and look visually as made of natural wood
las bandejas de melamine (imitación madera) tienen una superficie ligeramente ondulada y parecen estar hechas de madera natural
les plateaux de mélamine (imitation bois) ont une surface légèrement ondulée et donnent une impression visuelle de bois naturelle

	cm	↑ cm	GN	€
84180	53,0 x 32,5	1,5	1/1	35,00
84181	32,5 x 26,5	1,5	1/2	18,40
84182	32,5 x 17,6	1,5	1/3	13,00
84183	26,5 x 16,2	1,5	1/4	10,50
84184	53,0 x 16,2	1,5	2/4	21,00

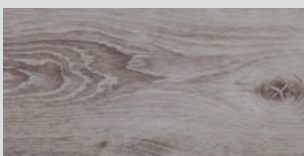
**1:1 Oberflächenansicht**

1:1 structural view



CIRCLE



84875

84876

Tablett „CIRCLE“
plate / tray
plato / bandeja
assiette / plateau



	Ø cm	↑ cm	Farbe / Colour	€
84875	32,0	3,5		28,00
84876	40,5	5,5		40,00



LA VIDA



Tablett „LA VIDA“
plate / tray
plato / bandeja
assiette / plateau



	Ø cm	↑ cm	Farbe / Colour	€
84165	32,0	3,5		28,00
84168	40,5	5,5		40,00
<hr/>				
	Ø cm	↑ cm	Farbe / Colour	€
84161	32,0	3,5		28,00
84170	40,5	5,5		40,00
<hr/>				
	Ø cm	↑ cm	Farbe / Colour	€
84171	32,0	3,5		28,00
84172	40,5	5,5		40,00

MARONE



Eine derbe Oberflächenstruktur schafft ein natürliches Erscheinungsbild. Die schwarzen Schalenvarianten mit braunem Rand inszenieren Ihr Gericht sehr stilvoll.

A rough surface structure creates a natural appearance. The black bowls and trays with brown border stage your dishes in a very stylish way.

La estructura rugosa de la superficie crea una apariencia natural. Los diferentes cuencos negros con borde marrón ponen con mucho estilo en escena sus platos.

La structure de surface rugueuse crée une apparence naturelle. Les différents bols noirs avec rebord marron mettent élégamment en scène vos plats.



Blattschale „MARONE“

leaf
fuente en forma de hoja
plateau feuille



	cm	↑ cm	ltr.	€
84100	25,5 x 14	5,5	0,4	8,20
84101	36,0 x 19	8,0	0,9	12,40



Tablett „MARONE“

tray
bandeja
plateau



	cm	↑ cm	€
84104	22,5 x 15	3	10,00
84105	27,5 x 11	2	10,00



Tablett „MARONE“

tray
bandeja
plateau



	cm	↑ cm	€
84103	14,5 x 14,5	2	5,40



Tablett „MARONE“

tray
bandeja
plateau



	cm	↑ cm	€
84106	26,5 x 16,5	4	11,60



Schale „MARONE“

bowl
cuenco
bol

	cm	↑ cm	ltr.	€
84731	16,5 x 10	5,5	0,25	10,00
84732	22,0 x 13	7,5	0,6	12,00
84733	27,5 x 19	9,0	1,4	14,00



Teller „MARONE“

plate
plato
assiette

	Ø cm	↑ cm	€
84728	16,0	2,5	6,80
84729	20,5	2,5	7,20
84730	28,0	3,5	8,80



Schale „MARONE“

bowl
cuenco
bol

	Ø cm	↑ cm	ltr.	€
84109	11	5,5	0,2	5,60



Schale „MARONE“

bowl
cuenco
bol

	Ø cm	↑ cm	ltr.	€
84107	8,5	2,5	0,05	5,40
84108	11,5	3,0	0,04	5,80



Tablett „MARONE“

tray
bandeja
plateau

	cm	↑ cm	€
84117	19,5 x 9,5	2	8,40
84118	39,0 x 16,0	3	16,50



Tablett „MARONE“

tray
bandeja
plateau

	cm	↑ cm	€
84119	32,5 x 23,5	4,5	16,50



Schale „MARONE“

bowl
cuenco
bol

	Ø cm	↑ cm	ltr.	€
84174	30,5	8,5	2	20,00



Schale „MARONE“

bowl
cuenco
bol

	Ø cm	↑ cm	ltr.	€
84110	14	6,0	0,30	6,40
84111	19	8,0	0,80	11,60
84112	21	8,5	1,00	12,00
84113	24	9,5	1,40	14,00



Schale „MARONE“

bowl
cuenco
bol

	cm	↑ cm	ltr.	€
84114	23,5 x 23,5	6,5	0,70	12,40

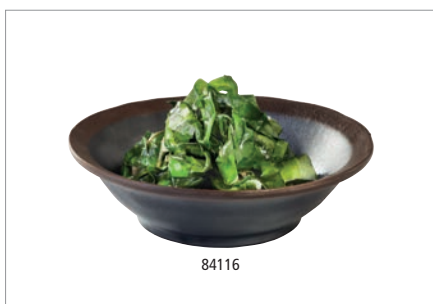

Schale „MARONE“

bowl
cuenco
bol

	Ø cm	↑ cm	ltr.	€
84115	11	3,5	0,13	5,40
84116	14	4,0	0,20	6,00

DARK WAVE



GN Tablett „DARK WAVE“

GN tray
GN bandeja
GN plateau



	cm	cm	GN	€	
84900	53,0	x 32,5	2	1/1	39,00
84901	32,5	x 26,5	2	1/2	20,00
84902	32,5	x 17,6	2	1/3	12,00
84903	53,0	x 16,2	2	2/4	19,00



Tablett „DARK WAVE“

tray
bandeja
plateau



	cm	cm	€	
84904	14	x 14	2	4,40



Tablett „DARK WAVE“

tray
bandeja
plateau

	cm	↑ cm	€
84905	23 x 10,5	1,5	6,00
84906	29 x 12,0	1,5	8,00



Teller „DARK WAVE“

plate
plato
assiette

	Ø cm	↑ cm	€
84907	14,5	1,5	3,20
84908	22,0	2,0	6,60
84909	27,0	2,5	10,00



Schale „DARK WAVE“

bowl
cuenco
bol

	Ø cm	↑ cm	ltr.	€
84910	17,5	5,0	0,50	7,40
84911	22,5	5,0	0,75	9,40
84912	32,0	3,5	-	16,00
84913	40,5	5,5	-	28,00



Schale „DARK WAVE“

bowl
cuenco
bol

	cm	↑ cm	ltr.	€
84914	18 x 18	10,0	1,6	12,00
84915	23 x 23	11,5	2,9	18,00

ZEN

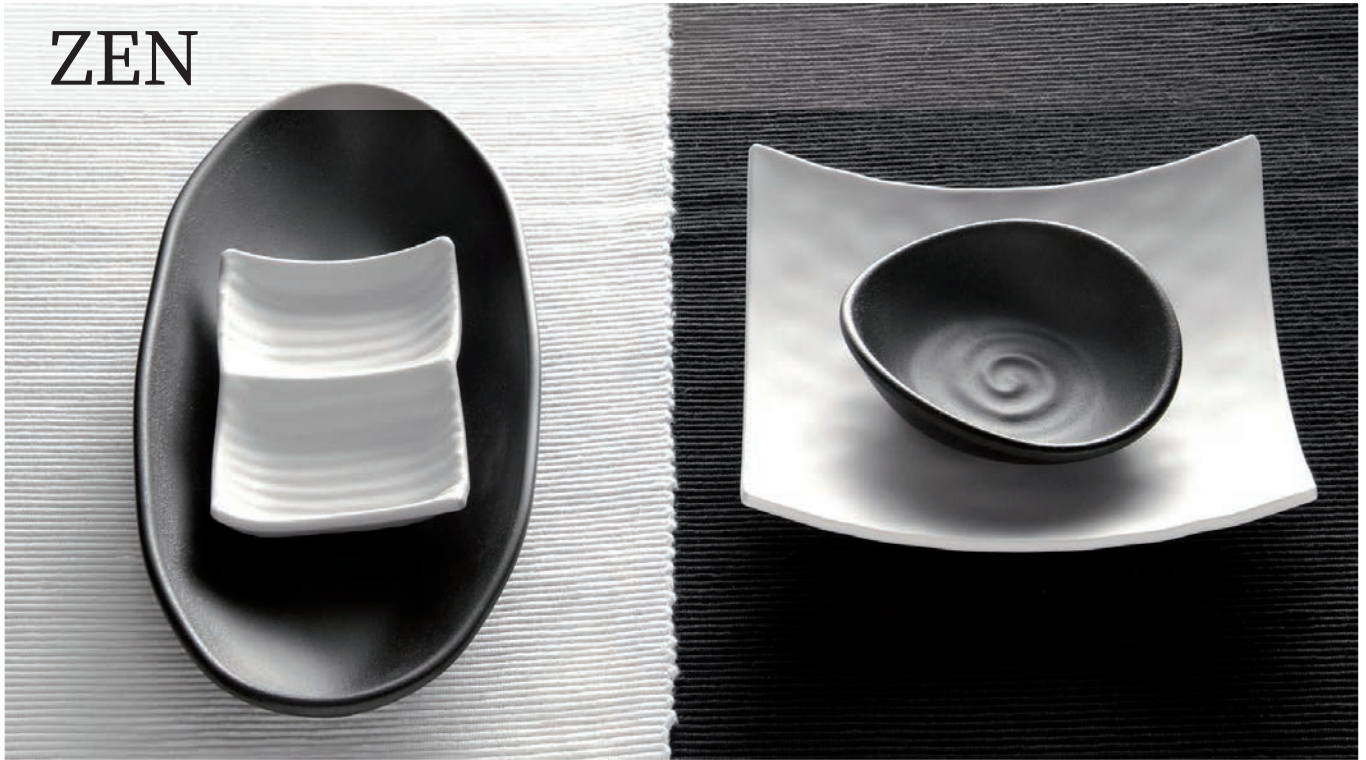

Fernöstliche Tisch- und Buffetartikel präsentiert die Serie ZEN. Die Optik entspricht dem japanischen Steingut.

The ZEN series presents Far Eastern table and buffet articles. The appearance is that of Japanese stoneware.

La colección ZEN presenta artículos de buffet y mesa para la cocina oriental. Su aspecto recuerda al gres japonés.

La collection ZEN présente des articles de buffet et de table pour la cuisine orientale. L'aspect de la mélamine rappelle le grès japonais.



Schale „ZEN“

bowl
cuenco
bol



	Ø cm	↑ cm	ltr	Farbe / Colour	€
83928	31	8,5	2,5	White	22,00
83929	31	8,5	2,5	Black	22,00



Schale „ZEN“

bowl
cuenco
bol



	Ø cm	↑ cm	ltr	Farbe / Colour	€
84354	22,5	12,5	0,80	White	10,20
84355	22,5	12,5	0,80	Black	10,20



Schale „ZEN“

bowl
cuenco
bol



	cm	↑ cm	ltr	Farbe / Colour	€
83710	21 x 21	11	1,40	White	11,00
83712	21 x 21	11	1,40	Black	11,00



Schale „ZEN“

bowl
cuenco
bol



84350



84349



84353

	Ø cm	↑ cm	ltr.	Farbe / Colour	€
84348	10,0	7,0	0,08		2,80
84350	12,5	8,5	0,15		4,20
84352	16,0	10,0	0,30		6,80

	Ø cm	↑ cm	ltr.	Farbe / Colour	€
84349	10,0	7,0	0,08		2,80
84351	12,5	8,5	0,15		4,20
84353	16,0	10,0	0,30		6,80



stapelbar
stackable

Schale „ZEN“

bowl
cuenco
bol



83735

	cm	↑ cm	ltr.	Farbe / Colour	€
83735	25,0 x 13,5	4	0,25		4,20
83739	30,5 x 17,5	5	0,60		8,40

Schale „ZEN“

bowl
cuenco
bol



	cm	↑ cm	ltr.	Farbe / Colour	€
83714	17,5 x 17,5	7	0,5		6,60
83716	17,5 x 17,5	7	0,5		6,60

Schale „ZEN“

bowl
cuenco
bol



	cm	↑ cm	ltr.	Farbe / Colour	€
83725	10,5 x 10,5	3	0,06		2,50
83727	10,5 x 10,5	3	0,06		2,50

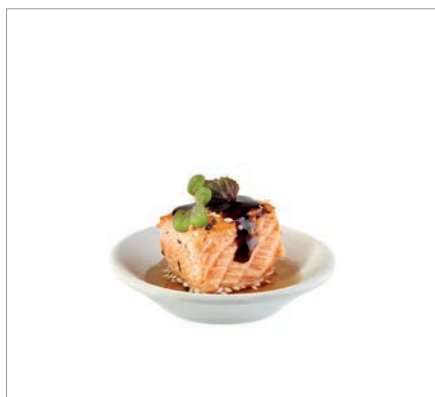

Dipschälchen „ZEN“

dip bowl
cuenco para dip
bol para dip



	∅ cm	↑ cm	ltr.	Farbe / Colour	€
83721	8	1,5	0,03		1,00
83723	8	1,5	0,03		1,00



Schale „ZEN“

bowl
cuenco
bol



	cm	↑ cm	ltr.	Farbe / Colour	€
83718	12 x 12	4	0,2		4,50
83720	12 x 12	4	0,2		4,50



Schale „ZEN“

bowl
cuenco
bol



	cm	↑ cm	ltr.	Farbe / Colour	€
83726	13 x 11	3,5	0,1		2,50
83728	13 x 11	3,5	0,1		2,50



Schale „ZEN“

bowl
cuenco
bol



	cm	↑ cm	ltr.	Farbe / Colour	€
83730	11 x 10	3	0,04		2,30
83732	11 x 10	3	0,04		2,30



Schale „ZEN“

bowl
cuenco
bol



	cm	↑ cm	ltr.	Farbe / Colour	€
83722	17,5 x 15,5	5,5	0,2		6,00
83724	17,5 x 15,5	5,5	0,2		6,00



Schale „ZEN“

bowl
cuenco
bol

	cm	↑ cm	ltr.	Farbe / Colour	€
83934	14,5 x 12,5	5	0,2	■	4,60
83935	14,5 x 12,5	5	0,2	■	4,60



Schale „ZEN“

bowl
cuenco
bol

	∅ cm	↑ cm	ltr.	Farbe / Colour	€
83932	11,5	4	0,15	■	4,40
83933	11,5	4	0,15	■	4,40



Schale „ZEN“

bowl
cuenco
bol

	cm	↑ cm	ltr.	Farbe / Colour	€
83946	9 x 7	2,5	0,05	■	3,20
83947	9 x 7	2,5	0,05	■	3,20



Schale „ZEN“

bowl
cuenco
bol

	cm	↑ cm	Farbe / Colour	€
83948	14 x 9	2,5	■	3,70
83949	14 x 9	2,5	■	3,70





Tablett / Teller „ZEN“

tray / plate
bandeja / plato
plateau / assiette



	∅ cm	↑ cm	Farbe / Colour	€
83940	28	3		9,50
83941	28	3		9,50



Tablett „ZEN“

tray
bandeja
plateau



	cm	↑ cm	Farbe / Colour	€
83734	23,5 x 23	5,5		8,40
83736	23,5 x 23	5,5		8,40



Tablett / Sushiboard „ZEN“

tray / sushiboard
bandeja para sushi
plateau sushi



	cm	↑ cm	Farbe / Colour	€
83742	22,5 x 9,5	3		4,20
83744	22,5 x 9,5	3		4,20



Tablett / Sushiboard „ZEN“

tray / sushiboard
bandeja para sushi
plateau sushi



	cm	↑ cm	Farbe / Colour	€
83738	22 x 12	3		5,60
83740	22 x 12	3		5,60

FUSION



Die Oberflächen der Serie FUSION sind innen hoch glänzend und außen mattiert. Das besondere Design beansprucht höchste Aufmerksamkeit und bringt Speisen optimal zur Geltung. Die Speisen werden noch mehr in den Blickpunkt gerückt.

The surfaces of the FUSION series have a mirror shiny inside and a matte outside. The unique design demands the utmost attention. The food moves even more in the focus.

Las superficies de la serie FUSION tienen un interior brillante y un exterior mate. El diseño único exige la máxima atención. Los platos reciben un enfoque aún mayor.

Les surfaces de la série FUSION sont brillantes à l'intérieur et mates à l'extérieur. Le design spéciale exige la plus grande attention. Les plats sont mise encore plus dans le centre de l'attention.



Schale „FUSION“

owl
cuenco
bol



	Ø cm	↑ cm	ltr.	€
84022	11	7,0	0,3	5,20
84023	17	8,5	1,0	9,80
84024	20	8,0	1,2	13,80



Tablett „FUSION“

tray
bandeja
plateau



	cm	↑ cm	€
84025	23,5 x 7,5	2	5,20

SINUS



Charakterstark und mit dem Anspruch an Funktionalität und Design präsentiert sich die Buffetserie SINUS. Die großzügigen Flächen für die Speisenpräsentation sind ausdrucksstark eingefasst und gewährleisten ein optimales Handling.

The SINUS buffet series is characterful and with a high standard of functionality and design. The spacious areas for the food presentation are expressively enclosed and ensure optimal handling in everyday dining.

La serie de buffet SINUS demuestra un carácter fuerte y tiene un alto nivel de funcionalidad y diseño. Las áreas espaciosas para la presentación de la comida son expresivamente enmarcadas y aseguran un manejo óptimo en la gastronomía.

La série de buffet SINUS est pleine de caractère et avec un haut niveau de fonctionnalité et de design. Les zones spacieuses pour la présentation de la nourriture sont expressivement encadrées et assurent une maniabilité optimale dans la restauration.



GN Tablett „SINUS“

GN tray
GN bandeja
GN plateau



	cm	↑ cm	GN	Farbe / Colour	€
84230	53 x 32,5	2	1/1	White	27,50
84231	53 x 16,2	2	2/4	White	17,00
	cm	↑ cm	GN	Farbe / Colour	€
84260	53 x 32,5	2	1/1	Black	27,50
84261	53 x 16,2	2	2/4	Black	17,00



Schale „SINUS“

bowl
cuenco
bol



	cm	↑ cm	ltr.	€
84229	10,5 x 10,5	4,0	0,1	3,50
84232	21,0 x 21,0	9,0	1,5	16,90
84233	25,0 x 25,0	11,0	2,4	21,80
84234	28,5 x 28,5	12,5	3,5	25,40

HALFTONE



Fingerfood Löffel „HALFTONE“

party spoon
cuchara party
cuillère party



	Ø cm	↑ cm	€
84158	5,5	7	3,00



Fingerfood Löffel „HALFTONE“

party spoon
cuchara party
cuillère party



	cm	↑ cm	€
84128	14,5 x 4,5	4,5	3,00



Tablett „HALFTONE“

tray
bandeja
plateau



	cm	↑ cm	€
84124	20,5 x 12,5	3	5,90
84125	24,5 x 15,0	3	7,20
84127	34,5 x 21,5	3	15,20



Tablett „HALFTONE“

tray
bandeja
plateau



	cm	↑ cm	€
84126	29 x 18	4	9,20



Schale „HALFTONE“

bowl
cuenco
bol



	Ø cm	↑ cm	ltr.	€
84217	8	4	0,1	3,20



Schale „HALFTONE“

bowl
cuenco
bol



	Ø cm	↑ cm	ltr.	€
84218	8,5	3,5	0,05	3,20



84130

Schale „HALFTONE“

bowl
cuenco
bol



	cm	↑ cm	ltr.	€
84130	11,5 x 7,0	4,0	0,05	2,80
84131	14,0 x 8,0	4,5	0,10	3,50
84132	15,0 x 9,5	5,0	0,15	3,90



84134

Schale „HALFTONE“

bowl
cuenco
bol



	cm	↑ cm	ltr.	€
84133	17,5 x 13,5	6,5	0,35	5,90
84134	24,0 x 17,5	7,5	0,8	10,50



84136

Schale „HALFTONE“

bowl
cuenco
bol



	cm	↑ cm	ltr.	€
84135	16,5	7,5	0,65	8,40
84136	19,0	8,5	1,00	10,50



Schale „HALFTONE“

bowl
cuenco
bol



	cm	↑ cm	ltr.	€
84137	26	9	1,5	17,00

TAO



83649

83648

83649

83625

Tablett / tray

Schale, rund „TAO“

bowl, round
cuenco, redondo
bol, rond

	cm	↑ cm	ltr.	Farbe / Colour	€
83648	10,5 x 10,0	6,5 / 3,0	0,07		3,40
83651	13,5 x 12,5	8,5 / 4,0	0,15		5,00
83654	17,0 x 16,0	10,5 / 4,5	0,3		7,40
	cm	↑ cm	ltr.	Farbe / Colour	€
83649	10,5 x 10,0	6,5 / 3,0	0,07		3,40
83652	13,5 x 12,5	8,5 / 4,0	0,15		5,00
83655	17,0 x 16,0	10,5 / 4,5	0,3		7,40



83642

Schale, quadratisch „TAO“

bowl, square
cuenco, cuadrado
bol creux carré

	cm	↑ cm	ltr.	Farbe / Colour	€
83642	30,5 x 30,5	10	3,3		18,50
83643	30,5 x 30,5	10	3,3		18,50



83640

Schale, rechteckig „TAO“

bowl, rectangular
cuenco, rectangular
bol creux rectangulaire

	cm	↑ cm	ltr.	Farbe / Colour	€
83639	32,5 x 17,5	10	1,8		14,50
83640	32,5 x 17,5	10	1,8		14,50

APART



GN Tablett „APART“

GN tray
GN bandeja
GN plateau



	cm	↑ cm	GN	€
83828	53,0 x 32,5	2,5	1/1	32,00
83830	32,5 x 26,5	2,5	1/2	18,00
83832	32,5 x 17,6	2,5	1/3	14,00



Tablett „APART“

tray
bandeja
plateau



	cm	↑ cm	€
83834	23,0 x 23,0	2,5	9,20
83836	33,0 x 33,0	2,5	19,00



Schale, rund „APART“

bowl, round
cuenco, redondo
bol, rond



	Ø cm	↑ cm	litr.	€
83800	6,5	3,0	0,045	1,30

Schale, eckig „APART“

bowl, square
cuenco, cuadrado
bol, carré



	cm	↑ cm	litr.	€
83808	6,6 x 6,6	3,0	0,05	1,40
83810	10 x 10	4,5	0,17	2,80
83812	15 x 15	6,5	0,5	6,80
83814	20 x 20	9,0	1,6	16,20
83816	25 x 25	9,0	2,6	22,00
83818	25 x 25	12,5	3,8	27,00
83820	30 x 30	12,5	4,5	32,00



GN 2/4 Schale „APART“

GN 2/4 bowl
GN 2/4 cuenco
GN 2/4 bol



	cm	↑ cm	GN	litr.	€
83826	53,0 x 16,2	6,5	2/4	3,0	21,00



Schale „GLOBAL BUFFET“

bowl
cuenco
bol



	cm	↑ cm	ltr.	Farbe / Colour	€
83785	32,5 x 32,5	12,0	3,0	White	21,00
83786	35,0 x 35,0	12,5	3,5	White	26,40
83787	40,0 x 40,0	13,5	5,0	White	33,90
	cm	↑ cm	ltr.	Farbe / Colour	€
84785	32,5 x 32,5	12,0	3,0	Black	21,00
84786	35,0 x 35,0	12,5	3,5	Black	26,40
84787	40,0 x 40,0	13,5	5,0	Black	34,00



Schale „GLOBAL BUFFET“

bowl
cuenco
bol



	cm	↑ cm	ltr.	Farbe / Colour	€
84464	35,5 x 31,5	14,0	2,5	White	16,00
84466	46,0 x 40,0	18,5	5,5	White	29,00



Schale „GLOBAL BUFFET“

bowl
cuenco
bol



	cm	↑ cm	ltr.	Farbe / Colour	€
84462	44 x 25	20	3,3	White	19,00



Schale „GLOBAL BUFFET“

bowl
cuenco
bol



	cm	↑ cm	ltr.	Farbe / Colour	€
83799	25,5 x 25,5	13,0	3,0	White	17,00
83788	32,0 x 32,0	16,5	4,5	White	21,40
83789	35,0 x 35,0	17,0	6,0	White	26,40
83790	40,0 x 40,0	17,5	8,0	White	34,00
	cm	↑ cm	ltr.	Farbe / Colour	€
83779	25,5 x 25,5	13,0	3,0	Black	17,00
84788	32,0 x 32,0	16,5	4,5	Black	21,40
84789	35,0 x 35,0	17,0	6,0	Black	26,40
84790	40,0 x 40,0	17,5	8,0	Black	34,00



Schale „GLOBAL BUFFET“

bowl
cuenco
bol



die Melaminschale wirkt optisch wie der Naturstein Granit
the melamine bowl looks visually as made of natural granit stone
el cuenco de melamina parece estar hecho de granito natural
le bol de mélamine donne une impression visuelle de granit naturel

	cm	↑ cm	ltr.	Farbe / Colour	€
84387	36 x 36	11	3,5	Black	24,00

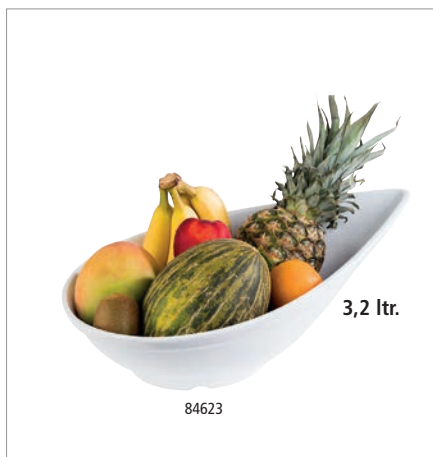

Schale „GLOBAL BUFFET“

bowl
cuenco
bol



	cm	↑ cm	ltr.	Farbe / Colour	€
84622	42 x 27	14	2,2		19,00
84623	50 x 32	17	3,2		29,00



Schale „LEAF“

bowl
cuenco
bol



	cm	↑ cm	ltr.	Farbe / Colour	€
84200	42 x 19,5	6,5	1,0		11,00
84202	50 x 23,0	7,5	1,5		16,80



Schale „BIG WAVE“

bowl
cuenco
bol



	cm	↑ cm	ltr.	Farbe / Colour	€
83587	33 x 24	8,5	1		18,20



Etagère „CASUAL“

etagère
expositor
présentoir



inklusive Edelstahl-Schild, beschriftbar
including stainless steel sign, inscribable
placa de acero inoxidable incluida, rotulable
étiquette en acier inox incluse, inscriptible

	Ø cm	↑ cm		€
34248	31 - 41 - 51	55	3-stufig / 3-tier 3 niveles / 3 étages	109,00
34247	31 - 41	35	2-stufig / 2-tier 2 niveles / 2 étages	66,00

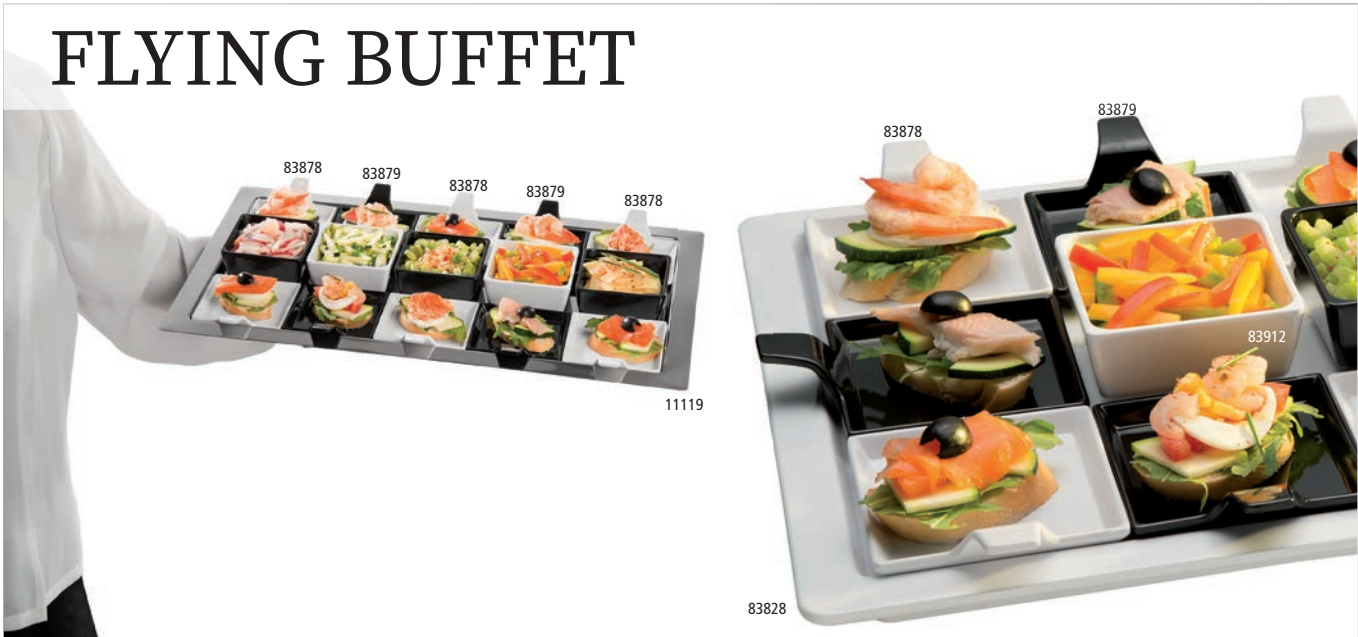

Fingerfood-Teller „FLYING BUFFET“
fingerfood plate
plato para el aperitivo
assiette pour apéritif



	cm	↑ cm	Farbe / Colour	€
83878	9,5 x 9,5	1,5 / 3,5	White	3,20
83879	9,5 x 9,5	1,5 / 3,5	Black	3,20



Schale „FLOAT“
bowl
cuenco
bol



	cm	↑ cm	Farbe / Colour	€
83912	9 x 9	4,5	White	3,00
83913	9 x 9	4,5	Black	3,00



GN Tablett „APART“
GN tray
GN bandeja
GN plateau



	cm	↑ cm	GN	€
83828	53 x 32,5	2,5	1/1	32,00



GN Edelstahl Tablett „FRAMES“
GN stainless steel platter
GN bandeja de acero inoxidable
GN plateau en acier inox



	cm	GN	€
11119	53 x 32,5	1/1	28,00

CASCADE



83963

83960

83962

Schale „CASCADE“

bowl
cuenco
bol



	cm	↑ cm	GN	litr.	€
83963	28,5 x 25,5	7,5		2,90	17,00
83960	32,5 x 26,5	7,5	1/2	3,65	18,00
83962	26,5 x 16,2	7,5	1/4	1,50	9,80



83964

83965

83967

Tablett „CASCADE“

tray
bandeja
plateau



	cm	↑ cm	GN	fits to	€
83964	28,5 x 25,5	2,4		83963	12,00
83965	32,5 x 26,5	2,4	1/2	83960	14,80
83967	26,5 x 16,2	2,4	1/4	83962	7,40



Tablett kann als Deckel eingesetzt werden!

Tray is also useable as a cover!

¡La bandeja se puede usar como tapa!

Le plat s'utilise aussi comme couvercle!



Gastronorm - Außenmaße Gastronorm - size Gastronorm - medidas exteriores Gastronorme - Gastronorme dimensions extérieures



GN 2/4 Schale „CASCADE“

GN 2/4 bowl
GN 2/4 cuenco
GN 2/4 bol



	cm	↑ cm	GN	ltr.	€
83961	53 x 16,2	7,5	2/4	3,65	19,40



GN 2/4 Tablett „CASCADE“

GN 2/4 tray
GN 2/4 bandeja
GN 2/4 plateau



	cm	↑ cm	GN	fits to	€
83966	53 x 16,2	2,4	2/4	83961	16,00



- Ideal für den Thekenbereich
- stapelbar mit Löffel und Deckel
- Schalenboden fixiert sich auf dem Deckel
- rutschfest (Antirutschfüßchen)

- ideal for the counter area
- stackable with spoon and lid
- the bottom of the bowl is fixed on the lid
- non-slip (with non-slip feet)

- idéal pour l'aire de comptoir
- empilable avec cuillère et couvercle
- le fond du bol se fixe sur le couvercle
- antidérapant (avec pieds antidérapants)

Schale „FLOAT“

bowl
cuenco
bol



	Ø cm	↑ cm	ltr.	Farbe / Colour	€
83900	5,5	3,0	0,03	White	1,50
83902	9,0	4,5	0,15	White	2,60
83904	13,0	6,5	0,45	White	6,30
83906	15,0	7,5	0,70	White	9,20
83908	20,5	10,0	1,90	White	15,80

	Ø cm	↑ cm	ltr.	Farbe / Colour	€
83901	5,5	3,0	0,03	Black	1,50
83903	9,0	4,5	0,15	Black	2,60
83905	13,0	6,5	0,45	Black	6,30
83907	15,0	7,5	0,70	Black	9,20
83909	20,5	10,0	1,90	Black	15,80





Schale „FLOAT“

bowl
cuenco
bol



	cm	↑ cm	ltr.	Farbe / Colour	€
83910	5,5 x 5,5	3,0	0,03	White	1,50
83912	9,0 x 9,0	4,5	0,16	White	3,00
83914	12,5 x 12,5	6,0	0,50	White	6,00
83916	19,0 x 19,0	9,5	1,90	White	14,20
83918	25,0 x 25,0	12,0	4,70	White	26,00
	cm	↑ cm	ltr.	Farbe / Colour	€
83911	5,5 x 5,5	3,0	0,03	Black	1,50
83913	9,0 x 9,0	4,5	0,16	Black	3,00
83915	12,5 x 12,5	6,0	0,50	Black	6,00
83917	19,0 x 19,0	9,5	1,90	Black	14,20
83919	25,0 x 25,0	12,0	4,70	Black	26,00



GN Tablett „FLOAT“

GN tray
GN bandeja
GN plateau



	cm	↑ cm	GN	Farbe / Colour	€
83923	53,0 x 32,5	3	1/1	White	33,00
83925	32,5 x 26,5	3	1/2	White	20,00
	cm	↑ cm	GN	Farbe / Colour	€
83924	53,0 x 32,5	3	1/1	Black	33,00
83926	32,5 x 26,5	3	1/2	Black	20,00



Deckel „FLOAT“ mit Löffelaussparung

cover, with notched for spoons
tapa, con espacio para la cuchara
couvrele, avec encoche pour la louche



	Ø cm	↑ cm	fits to	€
83920	20,5	1,3	83908, 83909	8,20



Deckel „FLOAT“ mit Löffelaussparung

cover, with notched for spoons
tapa, con espacio para la cuchara
couvrele, avec encoche pour la louche



	cm	↑ cm	fits to	€
83921	19 x 19	1,3	83916, 83917	8,20
83922	25 x 25	1,3	83918, 83919	10,40

PURE



83401

83479

Tablett „PURE“

tray
bandeja
plateau



	cm	↑ cm	GN	Farbe / Colour	€
83401	53,0 x 32,5	3	1/1		36,50
83588	35,4 x 32,5	3	2/3		26,80
83433	53,0 x 16,2	3	2/4		21,00
83480	32,5 x 26,5	3	1/2		19,00
83481	32,5 x 17,6	3	1/3		14,20
83482	26,5 x 16,2	3	1/4		10,50
83882	65,0 x 26,5	3			39,00
83597	40,0 x 30,0	3	Bäcker-Maß		26,80
83598	60,0 x 20,0	3	Bäcker-Maß		26,80
83599	60,0 x 40,0	3	Bäcker-Maß		55,00
	cm	↑ cm	GN	Farbe / Colour	€
83479	53,0 x 32,5	3	1/1		36,50
83589	35,4 x 32,5	3	2/3		26,80
83434	53,0 x 16,2	3	2/4		21,00
83490	32,5 x 26,5	3	1/2		19,00
83491	32,5 x 17,6	3	1/3		14,20
83492	26,5 x 16,2	3	1/4		10,50
83592	40,0 x 30,0	3	Bäcker-Maß		26,80
83593	60,0 x 20,0	3	Bäcker-Maß		26,80
83594	60,0 x 40,0	3	Bäcker-Maß		55,00



Tablett „PURE“

tray
bandeja
plateau

	cm	↑ cm	Farbe / Colour	€
83625	31,0 x 10,5	2		9,00
83403	35,5 x 18,0	3		12,00
83417	30,0 x 21,0	3		13,80
83402	53,0 x 18,0	3		23,80
	cm	↑ cm	Farbe / Colour	€
83483	53 x 18	3		23,50



Tablett „PURE COLOR“

tray
bandeja
plateau

	cm	↑ cm	GN	Farbe / Colour	€
83560	53,0 x 32,5	3	1/1		36,50
83562	32,5 x 26,5	3	1/2		19,00
83561	53,0 x 32,5	3	1/1		36,50
83563	32,5 x 26,5	3	1/2		19,00



Tablett quadratisch „PURE“

tray square
bandeja cuadrada
plateau carré

	cm	↑ cm	Farbe / Colour	€
83418	18,0 x 18,0	3		6,90
83407	21,0 x 21,0	3		9,60
83406	26,5 x 26,5	3		14,80
83405	37,0 x 37,0	3		19,50
83404	51,0 x 51,0	3		41,50
	cm	↑ cm	Farbe / Colour	€
83400	51 x 51	3		41,00



Tablett / Teller „PURE“

tray / plate
bandeja / plato
plateau / assiette

	Ø cm	↑ cm	Farbe / Colour	€
83884	31	2,5		17,80
83869	38	2,5		20,00
83886	41	2,5		22,40
83484	51	2,5		26,50



Schale „PURE“

bowl
cuenco
bol

	Ø cm	↑ cm	ltr.	Farbe / Colour	€
83450	5,5	4,0	0,02		1,60
83419	9,0	4,5	0,09		2,90
83453	13,0	6,5	0,30		6,30
83455	15,0	7,5	0,45		9,90
83415	20,0	10,5	1,25		17,80
	Ø cm	↑ cm	ltr.	Farbe / Colour	€
83451	5,5	4,0	0,02		1,60
83452	9,0	4,5	0,09		2,90
83454	13,0	6,5	0,30		6,30
83456	15,0	7,5	0,45		9,90
83457	20,0	10,5	1,25		17,80



Teller, rund „CASUAL“

plate, round
plato, redondo
assiette, ronde

	Ø cm	↑ cm	€
83500	22,5	2,5	7,00
83514	26,5	2,5	8,40



0,05 ltr. - 8,0 ltr.

Schale „PURE COLOR“

bowl
cuenco
bol

	cm	↑ cm	ltr.	Farbe / Colour	€
84424	6,5 x 6,5	3,0	0,05		2,10
83414	9,0 x 9,0	4,0	0,14		3,40
83410	12,5 x 12,5	6,5	0,40		5,60
83409	19,0 x 19,0	9,0	1,50		18,60
83408	25,0 x 25,0	12,0	3,80		30,00
84425	32,0 x 32,0	14,0	8,0		36,00
	cm	↑ cm	ltr.	Farbe / Colour	€
84426	6,5 x 6,5	3,0	0,05		2,10
83466	9,0 x 9,0	4,0	0,14		3,40
83467	12,5 x 12,5	6,5	0,40		5,60
83468	19,0 x 19,0	9,0	1,50		18,60
83469	25,0 x 25,0	12,0	3,80		30,00
84427	32,0 x 32,0	14,0	8,0		36,00
	cm	↑ cm	ltr.	Farbe / Colour	€
83568	9,0 x 9,0	4,0	0,14		3,40
83570	12,5 x 12,5	6,5	0,40		5,60
83572	19,0 x 19,0	9,0	1,50		18,60
83574	25,0 x 25,0	12,0	3,80		30,00
	cm	↑ cm	ltr.	Farbe / Colour	€
83569	9,0 x 9,0	4,0	0,14		3,40
83571	12,5 x 12,5	6,5	0,40		5,60
83573	19,0 x 19,0	9,0	1,50		18,60
83575	25,0 x 25,0	12,0	3,80		30,00



Schale „PURE BICOLOR“

bowl
cuenco
bol



	cm	↑ cm	ltr.	Farbe / Colour	€
84414	9,0 x 9,0	4,0	0,14		4,00
84410	12,5 x 12,5	6,5	0,40		7,00
84409	19,0 x 19,0	9,0	1,50		20,50
84408	25,0 x 25,0	12,0	3,80		32,50

	cm	↑ cm	ltr.	Farbe / Colour	€
84420	9,0 x 9,0	4,0	0,14		4,00
84421	12,5 x 12,5	6,5	0,40		7,00
84422	19,0 x 19,0	9,0	1,50		20,50
84423	25,0 x 25,0	12,0	3,80		32,50

	cm	↑ cm	ltr.	Farbe / Colour	€
84415	9,0 x 9,0	4,0	0,14		4,00
84416	12,5 x 12,5	6,5	0,40		7,00
84417	19,0 x 19,0	9,0	1,50		20,50
84418	25,0 x 25,0	12,0	3,80		32,50



Schale „SLATE“

bowl
cuenco
bol



	cm	↑ cm	ltr.	€
84244	19 x 19	9	1,5	20,00
84245	25 x 25	12	3,8	34,00



1:1 Oberflächenansicht
1:1 structural view



Deckel „PURE“ mit Löffelaussparung

cover with notched for spoons
tapa con espacio para la cuchara
couverture avec encoche pour la louche



	cm	↑ cm	fits to	€
83600	19 x 19	1,5	84409, 84417, 84422, 83409, 83468, 83572, 83573	8,00
83601	25 x 25	1,5	84408, 84418, 84423, 84430, 83575, 83574, 83469, 83408	10,50
83602	32 x 32	1,5	84425, 84427	12,00



Schale „PURE“

bowl
cuenco
bol



	cm	↑ cm	ltr.	€
83497	22,5 x 15,5	7,5	0,80	17,40
83498	38,5 x 15,5	7,5	1,50	28,50
83499	51,0 x 15,5	7,5	2,40	37,50



Tablett „SLATE“

tray
bandeja
plateau



	cm	↑ cm	€
84960	28 x 17,5	2,5	12,00
84961	Ø 28	2,5	12,00



GN Tablett „PURE GRANIT“

GN tray
GN bandeja
GN plateau



	cm	↑ cm	GN	€
84440	53,0 x 32,5	3	1/1	38,00
84441	32,5 x 26,5	3	1/2	19,50



Menage „PURE“

menage
conjunto aperitivo
set apéritif



4-teilig: 1 Ständer, Edeltahl matt poliert + 3 Melamin-Schalen, weiß (Nr. 83419)

4 pcs. set: 1 stainless stand satin polished finish + 3 white bowls (No. 83419)

set de 4: 1 soporte, acero inoxidable pulido mate + 3 cuencos de melamina blancos (ref. 83419)

set de 4: 1 support, acier inox poli mat + 3 bols de mélamine blancs (ref. 83419)

	cm	↑ cm	€
09924	14 x 14	16	23,00



Menage „PURE“

menage
conjunto aperitivo
set apéritif



5-teilig: 1 Ständer, Edeltahl matt poliert + 4 Melamin-Schalen, weiß (Nr. 83414)

5 pcs. set: 1 stainless stand satin polished finish + 4 square white bowls (No. 83414)

set de 5: 1 soporte, acero inoxidable pulido mate + 4 cuencos de melamina blancos (ref. 83414)

set de 5: 1 support, acier inox poli mat + 4 bols de mélamine blancs (ref. 83414)

	cm	↑ cm	€
09923	17 x 17	16	26,00



GN Tablett „FRAMES“

GN tray
GN bandeja
GN plateau



	cm	↑ cm	GN	€
84046	53,0 x 32,5	2	1/1	26,00
84047	32,5 x 26,5	2	1/2	14,20
84048	32,5 x 17,6	2	1/3	10,00



Schale / Pastateller „PURE“

bowl / pasta plate
cuenco / plato para pasta
bol / assiette creuse



	Ø cm	↑ cm	ltr.	Farbe / Colour	€
83412	32,0	7,5	1,5		16,20
83411	45,5	9,0	1,7		45,50

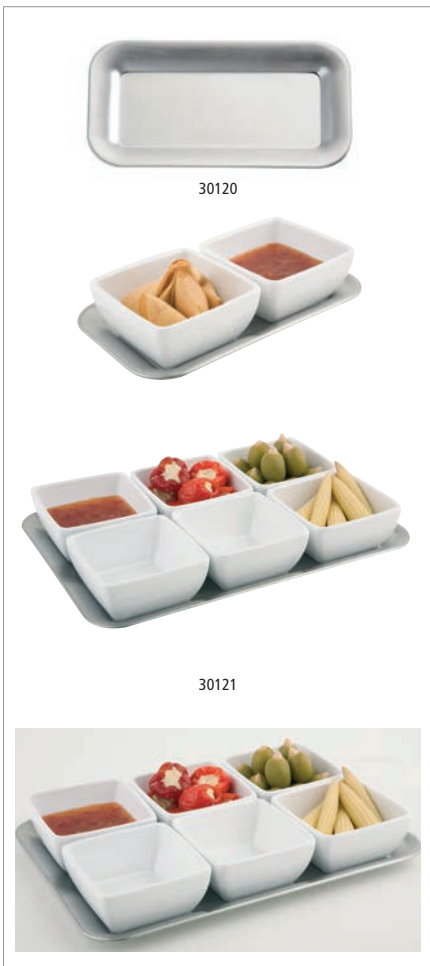

Tablett „MADE FOR PURE“

tray
bandeja
plateau



Edelstahl matt poliert, passend für Melamin-Schalen
stainless steel satin polished finish, for melamin bowls
acero inoxidable pulido mate, apta para cuencos de melamina
acier inox poli mat, pour bols de mélamine

	cm		€
30120	20 x 11	für 2 Schalen / for 2 bowls para 2 cuencos / pour 2 bols	6,80
30121	29 x 20	für 6 Schalen / for 6 bowls para 6 cuencos / pour 6 bols	14,00

Schale „PURE COLOR“ / bowl / cuenco / bol

	cm	↑ cm	ltr.	Farbe / Colour	€
83414	9 x 9	4	0,14		3,40
83466	9 x 9	4	0,14		3,40
83568	9 x 9	4	0,14		3,40
83569	9 x 9	4	0,14		3,40

Schale „PURE BICOLOR“ / bowl / cuenco / bol

	cm	↑ cm	ltr.	Farbe / Colour	€
84414	9 x 9	4	0,14		4,00
84415	9 x 9	4	0,14		4,00
84420	9 x 9	4	0,14		4,00

NATURAL COLLECTION



Blattschale „NATURAL COLLECTION“

leaf
fuente en forma de hoja
plateau feuille



	cm	↑ cm	Farbe / Colour	€
84083	40 x 18,5	3,5		14,80
84086	52 x 25,0	4,0		18,40
	cm	↑ cm	Farbe / Colour	€
84085	40 x 18,5	3,5		14,80
84088	52 x 25,0	4,0		18,40



Palmblattschale „NATURAL COLLECTION“

palm leaf
fuente en forma de hoja de palmera
plateau feuille de palme



	cm	↑ cm	litr.	Farbe / Colour	€
84080	40 x 18,5	10	1,8		23,00
84082	40 x 18,5	10	1,8		23,00



stapelbar, mit Löffelablage
stackable, for spoons
apilable, práctico para cubiertos de servicio
empilable, pratique pour déposer les couverts



Blattschale „NATURAL COLLECTION“

leaf
fuente en forma de hoja
plateau feuille



	cm	↑ cm	Farbe / Colour	€
83864	34,5 x 8	2,5		9,50
83862	34,5 x 8	2,5		9,50



Tablett „PINEAPPLE“

tray
bandeja
plateau



	cm	↑ cm	Farbe / Colour	€
84624	30 x 17	2,5	White	4,90



Palmblattschale „NATURAL COLLECTION“

palm leaf
fuente en forma de hoja de palmera
plateau feuille de palme



	Ø cm	↑ cm	ltr.	Farbe / Colour	€
83447	30	10,0	1,5	White	16,00
83896	35	12,5	4,5	White	35,70
83449	30	10,0	1,5	Green	16,00
83894	35	12,5	4,5	Green	35,70



Blattschale „NATURAL COLLECTION“

leaf
fuente en forma de hoja
plateau feuille



	cm	↑ cm	Farbe / Colour	€
83435	36 x 16	3,0	White	12,00
83438	45 x 24	3,0	White	16,00
83441	53 x 29	3,5	White	18,40
83437	36 x 16	3,0	Green	12,00
83440	45 x 24	3,0	Green	16,00
83443	53 x 29	3,5	Green	18,40



Palmblattschale „NATURAL COLLECTION“

palm leaf
fuente en forma de hoja de palmera
plateau feuille de palme



	cm	↑ cm	Farbe / Colour	€
83865	27 x 27	4,5	Green	14,80
83446	35 x 34	4,5	Green	18,40



Schale, oval „CLASSIC WAVE“

owl, oval
cuenco, ovalada
plateau ovale



	cm	↑ cm	ltr.	Farbe / Colour	€
83875	27 x 17	4,0	0,80	White	12,00
83876	34 x 21	4,5	1,30	White	15,50
83877	47 x 29	5,0	3,20	White	23,80



NEW

ENAMEL LOOK

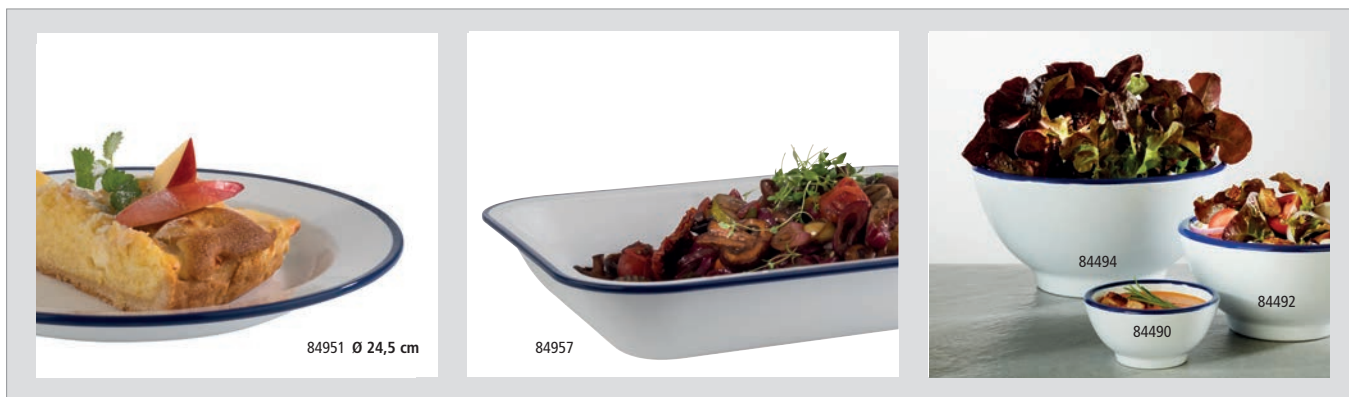

Suppenteller „ENAMEL LOOK“

soup plate
plato hondo
assiette creuse



	Ø cm	↑ cm	Farbe / Colour	€
84952	19,0	3		5,20
84953	22,5	4		6,60
84954	24,5	4		7,20



Schale „ENAMEL LOOK“

bowl
cuenco
bol



	Ø cm	↑ cm	ltr.	Farbe / Colour	€
84490	5,5	4,0	0,02		1,70
84491	9,5	4,5	0,09		3,00
84492	13,0	6,5	0,30		6,60
84493	15,0	7,5	0,45		10,40
84494	20,0	10,5	1,25		19,00



Schale „ENAMEL LOOK“

bowl
cuenco
bol

NEW



84955



84956

	cm	↑ cm	ltr.	Farbe / Colour	€
84955	15,5 x 11,5	3,5	0,25		3,90
84956	17,5 x 13,0	4,5	0,30		4,90



Teller „ENAMEL LOOK“

plate
plato
assiette

NEW



84950



84951

	Ø cm	↑ cm	Farbe / Colour	€
84950	20,5	2,0		5,20
84951	24,5	2,5		6,90



Schale „ENAMEL LOOK“

bowl
cuenco
bol

NEW



84958



84959

	cm	↑ cm	ltr.	Farbe / Colour	€
84958	15,0 x 11,5	6,5	0,30		3,00
84959	21,5 x 16,5	9,5	1,00		6,90



Schale „ENAMEL LOOK“

bowl
cuenco
bol

NEW



	cm	↑ cm	ltr.	Farbe / Colour	€
84957	29,0 x 23,5	5	1,5		10,00

CASUAL



Schälchen „CASUAL MINI“

bowl
cuenco
bol mini



	cm	↑ cm	ltr.	Farbe / Colour	€
83880	6,0	2,5	0,02	White	1,70
83881	7,5	3,5	0,05	White	2,10



Schale „CASUAL MAXI“

bowl
cuenco
bol



	Ø cm	↑ cm	ltr.	Farbe / Colour	€
83696	10	4,5	0,15	White	2,80
83698	12	5,5	0,25	White	3,40
83700	14	6,5	0,50	White	4,00
83704	20	9,2	1,80	White	8,40
83702	23	10,5	2,50	White	9,40

	Ø cm	↑ cm	ltr.	Farbe / Colour	€
83697	10	4,5	0,15	Black	2,80
83699	12	5,5	0,25	Black	3,40
83701	14	6,5	0,50	Black	4,00
83705	20	9,2	1,80	Black	8,40
83703	23	10,5	2,50	Black	9,40

Deckel „FLOAT“ mit Löffelaussparung / cover, with notched for spoons / tapa, con espacio para la cuchara / couvercle, avec encoche pour la louche

	Ø cm	↑ cm	fits to	€
83920	20,5	1,3	83704, 83705	8,20

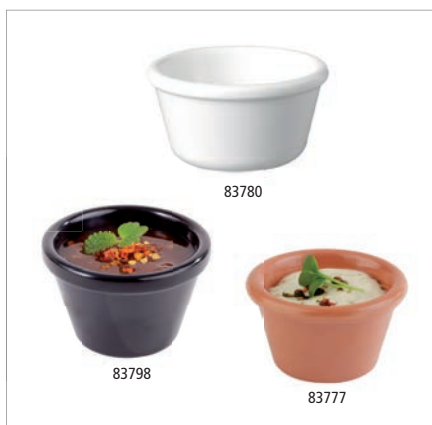

Dip-Schälchen „CASUAL“

dip bowl
cuenco para dip
ramequin



	Ø cm	↑ cm	ltr.	Farbe / Colour	VE / unit	€/ pc.
83780	6,0	3,7	0,04	White	24	0,90
83781	7,0	3,7	0,05	White	24	1,20
83782	7,8	4,0	0,08	White	24	1,50
83783	8,5	4,5	0,11	White	24	1,60
83784	9,8	4,5	0,14	White	12	1,90
83798	6,0	3,7	0,04	Black	24	1,10
83777	6,0	3,5	0,03	Terracotta	24	1,10



Schale „SCANTIC“

bowl
cuenco
bol



	cm	↑ cm	ltr.		€
84221	26,5 x 10,5	6,5	1,0		9,60
84222	53,0 x 10,5	6,5	2,0		18,20



Schale „ORGANIC“

bowl
cuenco
bol



	cm	↑ cm	ltr.	Farbe / Colour	€
84235	32,5 x 17	5,5	1,0	White	8,60
84236	50,0 x 26	6,5	3,5	White	24,00



Schale „CASUAL“

bowl
cuenco
bol



	Ø cm	↑ cm	ltr.		€
84215	10	6,5 / 8,5	0,2		4,80
84216	12	7,5 / 9,5	0,3		6,20



Schale „TIERRA“

bowl
cuenco
bol



	Ø cm	↑ cm	ltr.	Farbe / Colour	€
84295	10	7	0,13	White	2,70



Dipschale „CASUAL“

dip tray
bandeja para dips
plateau pour dips



	cm	↑ cm		€
84220	29 x 9	3		6,60

NEW

CLASSIC

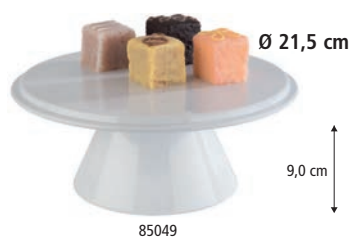

Serier- und Tortenplatte „CLASSIC“

cake stand
porta pasteles
présentoir à gâteaux



Rand fixiert die Haube
carved edge fixes the cover
ranura para fijar bien la campana
bord rainuré pour maintenir ferme la cloche

	Ø cm	↑ cm	€
85049	21,5	9	19,00
85050	21,5	17	25,00
85051	30,5	9	28,00
85052	30,5	17	34,00
85053	37,5	9	36,00
85054	37,5	17	42,00

Frischhalte- Haube / cover / campana / cloche



	Ø cm	↑ cm	fits to	€
06519 NEW	21	17	85049, 85050	24,00
06520	30	22	85051, 85052	29,90
06521 NEW	36	27	85053, 85054	56,00

Frischhalte- Haube / cover / campana / cloche



	Ø cm	↑ cm	fits to	€
06512	30	11,5	85051, 85052	6,20



Torten- / Konditorplatte

cake stand
soporte para pastel
présentoir à gâteaux

Rand fixiert die Haube, mit Antirutsch-Füßchen

carved edge fixes the cover, with non-slip feet

ranura para fijar bien la campana, con pies antideslizantes

bord rainuré pour maintenir ferme la cloche, avec pieds antidérapants



	Ø cm	↑ cm	Farbe / Colour	€
00468	31	3,5		15,00
00469	31	3,5		15,00



Torten- / Konditorplatte

cake stand
soporte para pastel
présentoir à gâteaux

Rand fixiert die Haube, mit Antirutsch-Füßchen

carved edge fixes the cover, with non-slip feet

ranura para fijar bien la campana, con pies antideslizantes

bord rainuré pour maintenir ferme la cloche, avec pieds antidérapants



	Ø cm	↑ cm	€
85044	21,5	2,5	12,00
00468	31,0	3,5	15,00
85045	37,5	4,0	32,00

Frischhalte- Haube / cover / campana/ cloche



	Ø cm	↑ cm	fits to	€
06519 NEW	21	17	85044	24,00
06520	30	22	00468	29,90
06521 NEW	36	27	85045	56,00



Servier- und Tortenplatte „CASUAL“

cake plate
porta pasteles
présentoir à gâteaux



	Ø cm	↑ cm	€
83890	31	8	24,00
83891	31	16	30,00



Servier- und Tortenplatte „CASUAL“

cake plate
porta pasteles
présentoir à gâteaux



	cm	↑ cm	€
83892	31 x 31	8	27,00
83893	31 x 31	16	32,50

**Tablett / Teller „PURE“**tray / plate
bandeja / plato
plateau / assiette

	Ø cm	↑ cm	Farbe / Colour	€
83869	38	2,5	White	20,00

Rolltophaube / rolltop cover / campana abatible / cloche basculante

	Ø cm	↑ cm		€
18388	38	20	mit verchromtem Kugelgriff / with chrome plated handle con pomo cromado / avec bouton chromé	21,00

**Frischhalte-Haube**cover
campana
cloche

	Ø cm	↑ cm		€
06510	30	11,5		4,40
06512	30	11,5	mit verchromtem Griff / with chrom plated handle con botón cromado / avec bouton chromé	6,20

**Schale „BALANCE“**bowl
cuenco
bol

	Ø cm	↑ cm	ltr.	Farbe / Colour	€
84040	14,5	9,0	0,4	White	5,20
84041	21,0	13,0	1,5	White	11,50
84042	24,5	15,0	2,5	White	15,00
84043	30,0	19,5	5,0	White	25,00

	Ø cm	↑ cm	ltr.	Farbe / Colour	€
85040	14,5	9,0	0,4	Black	5,20
85041	21,0	13,0	1,5	Black	11,50
85042	24,5	15,0	2,5	Black	15,00
85043	30,0	19,5	5,0	Black	25,00

Buffetständer „KING“ / buffet stand / soporte para buffet / présentoir buffet

	Ø cm	↑ cm		€
03622	15	14		36,00
03623	15	21		39,60

**Besteckablage „SPOON“**

cutlery rest
reposa cuchara
pose-cuillère



	cm	↑ cm	€
83801	26 x 10,5	5	6,00

**Besteckablage „BOWL“**

cutlery rest
reposa cuchara
pose-cuillère



	cm	↑ cm	ltr.	€
83803	22,5 x 11	6	0,5	6,40

**Besteckablage „SMALL WAVE“**

cutlery rest
reposa cuchara
pose-cuillère



	cm	↑ cm	€
83897	26 x 13	4,5	8,90

**Teller mit Glashalter „COCKTAIL“**

plate with glass holder
plato sujeta copas
assiette porte-verre



eignet sich besonders für Stehempfänge, einhändig nutzbar
particularly suitable for standing receptions, single-handed use
para uso en recepciones de pie, facil de usar con sólo una mano
particulièrement pour des receptions debout, utilisable avec une seule main

	cm	↑ cm	€
84620	22 x 14	1,5	3,00
	Ø cm	↑ cm	€
84621	19	1,5	3,00

**Kaffeebecher „CASUAL“**

coffee cup
taza de café
tasse à café



	Ø cm	↑ cm	ltr.	€
83513	9,5	10	0,4	5,90

**Eierbecher, 4er Set**

egg holder, 4 pcs. set
huevera, set de 4
coquetier, set de 4



	Ø cm	↑ cm	pcs.	€
83851	8	3	4	6,40
83848	8,5	2	4	5,90

FINGERFOOD LÖFFEL



Fingerfood Löffel „HALFTONE“

party spoon
cuchara party
cuillère party



	Ø cm	↑ cm	Farbe / Colour	VE / unit	€/pc.
84158	5,5	7	■ ■	24	3,00



Fingerfood Löffel „HALFTONE“

party spoon
cuchara party
cuillère party



	cm	↑ cm	Farbe / Colour	VE / unit	€/pc.
84128	14,5 x 4,5	4,5	■ ■	12	3,00



Fingerfood Löffel „BOAT“

party spoon
cuchara party
cuillère party



	cm	↑ cm	Farbe / Colour	VE / unit	€/pc.
84140	14,5 x 4,5	4,5	■ ■	32	2,90
84141	14,5 x 4,5	4,5	■ ■	32	2,90
84142	14,5 x 4,5	4,5	■ ■	12	2,90

**Fingerfood Löffel „HONG KONG“**

party spoon
cuchara party
cuillère party



	cm	↑ cm	Farbe / Colour	VE / unit	€/pc.
83486	13 x 4,5	4,5		60	1,20
83487	13 x 4,5	4,5		60	1,20
83424	13 x 4,5	4,5		60	1,20
83426	13 x 4,5	4,5		60	1,20

**Fingerfood-Löffel „MING HING“**

party spoon
cuchara party
cuillère party



	cm	↑ cm	Farbe / Colour	VE / unit	€/pc.
83842	11 x 4,5	4		60	1,10
83843	11 x 4,5	4		60	1,10

**Fingerfood-Löffel „LEAF“**

party spoon
cuchara party
cuillère party



	cm	↑ cm	Farbe / Colour	VE / unit	€/pc.
83889	10 x 4,5	1,5		50	1,80
83887	10 x 4,5	1,5		50	1,80
83888	10 x 4,5	1,5		50	1,80



MINI



84625

84626

84627

Schale „MINI COLOUR“

bowl
cuenco
bol



	cm	↑ cm	ltr.	Farbe / Colour	VE / unit	€/ pc.
84625	12,5 x 9,0	3,5	0,02		12	2,90
84626	12,5 x 9,0	3,5	0,02		12	2,90
84627	12,5 x 9,0	3,5	0,02		12	2,90



84840

84841

Schale „MINI LEAF“

bowl
cuenco
bol



	cm	↑ cm	ltr.	Farbe / Colour	VE / unit	€/ pc.
84840	10,5 x 7,5	2,5	0,04		40	2,00
84841	10,5 x 7,5	2,5	0,04		40	2,00



84842

84843

Schale „MINI LEAF“

bowl
cuenco
bol



	cm	↑ cm	ltr.	Farbe / Colour	VE / unit	€/ pc.
84842	10,5 x 6,5	4,5	0,06		40	2,00
84843	10,5 x 6,5	4,5	0,06		40	2,00



84844

84845

Schale „MINI LEAF“

bowl
cuenco
bol



	cm	↑ cm	ltr.	Farbe / Colour	VE / unit	€/ pc.
84844	14,5 x 6,0	3,0	0,05		40	2,20
84845	14,5 x 6,0	3,0	0,05		40	2,20



Schale „MINI“

bowl
cuenco
bol

84750



84760

	cm	↑ cm	ltr.	Farbe / Colour	VE / unit	€ / pc.
84750	8 x 8	3	0,06		24	2,80
84760	8 x 8	3	0,06		24	2,80



Schale „MINI“

bowl
cuenco
bol

84751



84761

	cm	↑ cm	ltr.	Farbe / Colour	VE / unit	€ / pc.
84751	9,5 x 9,5	3	0,1		24	3,00
84761	9,5 x 9,5	3	0,1		24	3,00



Schale „MINI“

bowl
cuenco
bol

84752



84762

	cm	↑ cm	ltr.	Farbe / Colour	VE / unit	€ / pc.
84752	9,5 x 8	3	0,08		24	2,90
84762	9,5 x 8	3	0,08		24	2,90



Schale / Schiffchen „MINI“

bowl
cuenco
bol

84753



84763

	cm	↑ cm	ltr.	Farbe / Colour	VE / unit	€ / pc.
84753	12,5 x 5,5	4	0,06		24	2,90
84763	12,5 x 5,5	4	0,06		24	2,90



Schale / Schiffchen „MINI“

bowl
cuenco
bol

84754



84764

	cm	↑ cm	ltr.	Farbe / Colour	VE / unit	€ / pc.
84754	14 x 6,5	4	0,1		24	3,20
84764	14 x 6,5	4	0,1		24	3,20



Teller „MINI“

plate
plato
assiette

	cm	↑ cm	ltr.	VE / unit	€/ pc.
84444	10,5 x 8,5	2,0	0,07	20	3,00



Schale „MINI“

bowl
cuenco
bol

	cm	↑ cm	ltr.	VE / unit	€/ pc.
84445	10,5 x 6,0	4,0	0,07	20	3,00
84446	13,5 x 7,5	3,0	0,07	20	3,00
84448	9,5 x 9,0	5,5	0,09	20	3,00
84449	13,0 x 12,0	7,5	0,18	20	4,00



Schale „MINI“

bowl
cuenco
bol

	Ø cm	↑ cm	ltr.	Farbe / Colour	€
84775	8,5	2,5	0,07		2,60
84778	8,5	2,5	0,07		2,60
84781	8,5	2,5	0,07		2,60



Schale „MINI“

bowl
cuenco
bol

	Ø cm	↑ cm	ltr.	Farbe / Colour	€
84776	8,5	2,5	0,07		2,60
84779	8,5	2,5	0,07		2,60
84782	8,5	2,5	0,07		2,60



Schale „MINI“

bowl
cuenco
bol

	cm	↑ cm	ltr.	Farbe / Colour	€
84777	9,5 x 5,5	5,5	0,07		2,60
84780	9,5 x 5,5	5,5	0,07		2,60
84783	9,5 x 5,5	5,5	0,07		2,60



Schale „MINI“
bowl
cuenco
bol

MF MELAMINE

	cm	↑ cm	ltr.	VE / unit	€ / pc.
84452	11,5 x 7,5	3,0	0,06	24	1,60
84454	11,5 x 6,0	5,5	0,04	24	1,60
84456	8,5 x 7,0	6,0	0,07	24	1,60
84458	8,0 x 8,0	4,0	0,10	24	1,60
84450	7,5 x 7,0	4,5	0,05	24	1,60

Schälchen „GOURMET“ / bowl / cuenco / bol

	Ø cm	↑ cm	ltr.	€
84018	7	6	0,05	2,00



Schale „HALFTONE“
bowl
cuenco
bol

MF MELAMINE

	Ø cm	↑ cm	ltr.	VE / unit	€ / pc.
84217	8,0	4,0	0,1	12	3,20
84218	8,5	3,5	0,05	12	3,20



Schale „MINI“
bowl
cuenco
bol

MF MELAMINE

	cm	↑ cm	ltr.	VE / unit	€ / pc.
84460	35 x 4,5	3	0,20	10	2,60

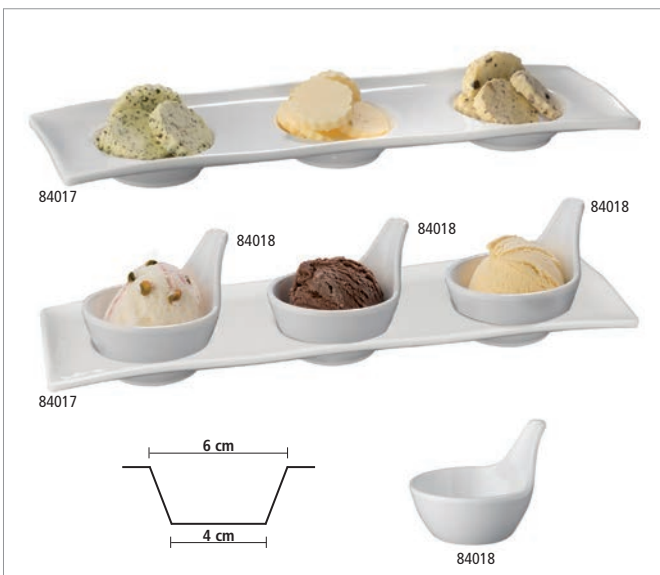

Tablett „GOURMET“
tray
bandeja
plateau

MF MELAMINE

mit 3 Absätzen Ø 4 cm
with 3 holes Ø 4 cm
con 3 agujeros Ø 4 cm
avec 3 trous Ø 4 cm

	cm	↑ cm	€
84017	30,5 x 9,5	2,5	7,60

Schälchen „GOURMET“ / bowl / cuenco / bol

	Ø cm	↑ cm	ltr.	€
84018	7	6	0,05	2,00



Tableware Table Presentation

Tableware
Table Presentation

Schalen
Teller
Mühlen
Leuchter
Tischsets

bowls
trays
mills
candle holders
placemats

cuencos
bandejas
molinillos
candelabros
mantelinas

bols
plateaux
moulins
chandeliers
sets de table



NEW

Servierkelle - *super trendy*



Servierkelle „BOB“

serving trowel
paleta para servir
truelle de service

EDELSTAHL
STAINLESS
INOXHOLZ
WOOD

Edelstahl Servierkelle mit schwarzem Holzgriff

stainless steel serving trowel with black wooden handle
paleta para servir de acero inoxidable con mango de madera negra
truelle de service en acier inox avec manche en bois noir

	cm	↑ cm	Griff		€
40680	23,5 x 15,5	12,5	13,5	stainless steel	16,00
40681	23,5 x 15,5	12,5	13,5	■	16,00



NEW

Snackbox „INDUSTRIAL“

snack box
caja tentempié
casse-croûte

METALL



Metall, schwarz
metal, black
metal, negro
métal, noir

	cm	↑ cm	ltr.	€
40675	16,5 x 10,5	7,50	0,5	12,00
40676	23,0 x 15,5	13,0	2,4	14,00



stapelbar
stackable

NEW



30130



30131



30132



30132



30133



30133

Tablett „VINTAGE“

tray
bandeja
plateau



Edelstahl-Look vintage
stainless steel vintage look
acero inoxidable look vintage
acier inox look vintage

	cm	↑ cm	€
30130	26,0 x 13,5	1,5	7,00
30131	34,0 x 18,0	1,5	12,00
30132	38,0 x 26,5	1,5	19,00
30133	25,5 x 16,0	3,0	14,00

passende Schälchen / fitting bowls / cuencos adecuados / bols apropiés

	Ø cm	↑ cm	ltr.	€
40655	7,5	5,5	0,17	2,60
40656	7,5	10,0	0,35	3,20



S. 276
page 276

40656

40655



30130



30132

Servierbeispiel
serving example

passendes Wachspapier / greaseproof paper squares / papel alimenticio para cucurucho / papier alimentaire pour cornet

	cm	pcs.		€
40670	42 x 25	500	Motiv: Zeitung	57,00
40671	42 x 25	500	blank	31,00
40672	42 x 25	500	Motiv: rote Karos / red	57,00
40673	42 x 25	500	Motiv: blaue Karos / blue	57,00
40674	30 x 20	500	Motiv: Fast Food / black	37,00



40672

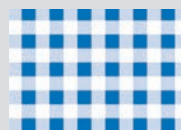

40673



40674

Tablett „TREND“

baking sheet
bandeja
plateau



ein Backblech wird zum Serviertablett
a baking sheet which becomes a serving tray
una bandeja de hornear que se convierte en una bandeja de servir
un moule qui devient un plateau de service

	cm	↑ cm	€
13380	32 x 21,5	2	9,00



40672



NEW

CAST IRON

Die Servierpfännchen aus emailliertem Gußeisen dienen dem portionsweisen Servieren und halten die Speisen warm.

The serving pans made of enameled cast iron are used for serving in portions and for keeping the food warm.

Las fuentes de hierro fundido esmaltado se utilizan para servir en porciones y mantener la comida caliente.

Les plateaux de service en fonte émaillée sont utilisés pour servir en portions et garder les aliments au chaud.



Servierpfännchen „CAST IRON“ serving pan fuente para servir plat de service



Gusseisen emailliert
enamelled cast iron
hierro fundido esmaltado
fonte émaillée

	Ø cm	↑ cm	Farbe / Colour	€
88220	10	2		14,00
88225	10	2		14,00
88221	13	2		16,00
88226	13	2		16,00



stapelbar
stackable



Servierbeispiel
serving example



Servierbeispiel
serving example



Servierpfännchen „CAST IRON“

servicing pan
fuente para servir
plat de service



Gusseisen emailliert
enamelled cast iron
hierro fundido esmaltado
fonte émaillée

	cm	↑ cm	Farbe / Colour	€
88222	13 x 13	2		16,00
88227	13 x 13	2		16,00
88223	16 x 13	2		18,00
88228	16 x 13	2		18,00
88224	20 x 13	2		20,00
88229	20 x 13	2		20,00



Präsentationsmöglichkeit
presentation example



00880



Genusspalette im Kleinformat, Birke / mini serving palett, birch / tabla de servir, formato pequeño, abedul / planche de service, petit format, bouleau

	cm	↑ cm	fits to	€
00880	20 x 12	3	88223, 88228	8,80



15623



Buffetständer „ACACIA“, Akazienholz geölt / buffet stand, acacia wood oiled / suporte para buffet, madera de acacia aceitada / présentoir buffet, bois d'acacia huilé

	cm	↑ cm	GN	€
15623	53 x 16,2	20	2/4	44,00



88224



00880
passende Genusspalette S. 53
matching board page 53



Ø 10 cm

88220

SNACKHOLDER



Die Mini-Edestahlkörbchen dienen dem portionsweisen Servieren. Zum originellen Servieren von Beilagen geeignet, aber auch zum Frittieren selbst.

The mini frying baskets are used to present individual portions in an original way, but can still be used to fry.

Las cestas de freir ofrecen una presentación original para el servicio de tapas o raciones individuales de patatas, aperitivos, fritos, etc.

Les paniers à friture offrent une présentation originale pour servir apéritifs, snacks, tapas et autres rations individuelles. Également aptes pour frire.



40600

Servier-Frittierkorb „SNACKHOLDER“

stainless steel fry baskets
cestitas inox para el servicio mesa
paniers inox pour le service sur table



	Ø cm	↑ cm	Griff	€
40600	8	7,5	9,5	8,00
40601	9	8,5	9,0	9,80



40610

Servier-Frittierkorb „SNACKHOLDER“

stainless steel fry baskets
cestitas inox para el servicio mesa
paniers inox pour le service sur table



	cm	↑ cm	Griff	€
40610	21,5 x 10,5	4,5	9,5	13,60
40611	26,0 x 13,0	5,0	9,0	16,00



40620

Servier-Frittierkorb „SNACKHOLDER“

stainless steel fry baskets
cestitas inox para el servicio mesa
paniers inox pour le service sur table



	cm	↑ cm	Griff	€
40620	10,0 x 8,5	6,5	9,0	11,20
40621	13,0 x 10,5	9,0	13,5	14,50

SNACKHOLDER



Made from PVD coated stainless steel

Die Mini-Edestahlkörbchen dienen dem portionsweisen Servieren. Zum originellen Servieren von Beilagen geeignet, aber auch zum Frittieren selbst.

The mini frying baskets are used to present individual portions in an original way, but can still be used to fry.

Las cestas de freir ofrecen una presentación original para el servicio de tapas o raciones individuales de patatas, aperitivos, fritos, etc.

Les paniers à friture offrent une présentation originale pour servir apéritifs, snacks, tapas et autres rations individuelles. Également aptes pour frire.



40602

Servier-Frittierkorb „SNACKHOLDER“

stainless steel fry baskets
cestitas inox para el servicio mesa
paniers inox pour le service sur table



	Ø cm	↑ cm	Griff	Farbe / Colour	€
40602	8	7,5	9,5		10,50
40603	9	8,5	9,0		11,90



40613

Servier-Frittierkorb „SNACKHOLDER“

stainless steel fry baskets
cestitas inox para el servicio mesa
paniers inox pour le service sur table



	cm	↑ cm	Griff	Farbe / Colour	€
40612	21,5 x 10,5	4,5	9,5		16,00
40613	26,0 x 13,0	5	9,5		18,60



40622

Servier-Frittierkorb „SNACKHOLDER“

stainless steel fry baskets
cestitas inox para el servicio mesa
paniers inox pour le service sur table



	cm	↑ cm	Griff	Farbe / Colour	€
40622	10,0 x 8,5	6,5	9,0		14,50
40623	13,0 x 10,5	9,0	13,5		17,90

**Snackholder**

serving cup
vaso para servir
gobelet à apéritif

Edelstahl, außen verkupfert

stainless steel, outside copper coated
acero inoxidable, el exterior está cubierto de cobre
acier inoxydable, l'extérieur est cuivré



	Ø cm	↑ cm	ltr.	Farbe / Colour		€
40616	9,5	8,5 / 11,5	0,45		kupfer / copper	5,60
40617	8,5	8,5	0,35		kupfer / copper	4,20
40618	8,5	8,5	0,35		gehämmerte Oberfläche / hammered	4,60

**Snackholder**

serving cup
vaso para servir
gobelet à apéritif



	Ø cm	↑ cm	ltr.		€
40605	9,5	8,5 / 11,5	0,45		4,90
40606	8,5	8,5	0,35		3,60
40607	8,5	8,5	0,35	gehämmerte Oberfläche / hammered	4,00

**Servier- / Saucen-Eimer „SNACKHOLDER“**

mini stainless steel bucket
cubo inox en formato mini
seau mini inox

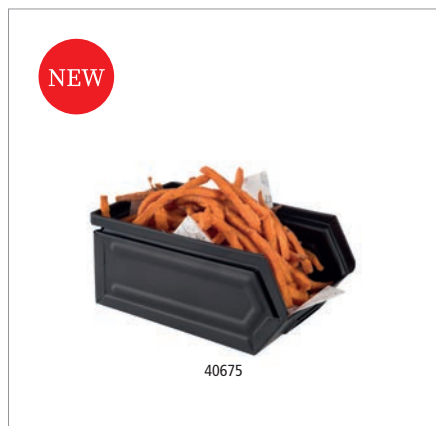

	Ø cm	↑ cm	ltr.	pcs.	€
40630	7	6,5	0,15	4	12,00
40631	9	8,5	0,33	1	4,20

**Snackbox „INDUSTRIAL“**

snack box
caja tentempié
casse-croûte

Metall, schwarz

metal, black
metal, negro
métal, noir



	cm	↑ cm	ltr.	€
40675	16,5 x 10,5	7,5	0,5	12,00
40676	13,0 x 10,5	9,0	2,4	14,00

**Mini-Milchkanne „SNACKHOLDER“**

mini milk can
lechera en formato mini
pot à lait mini



	Ø cm	↑ cm	ltr.	pcs.	€
40640	4,5	5	0,08	4	14,00

**Mini-Servierpfanne „SNACKHOLDER“**

mini pan
sartén en formato mini
poêle à frire mini



	cm	↑ cm	ltr.	€
40660	14,5 x 9,5	4,5 / 6,5	0,5	9,00

**Wachspapier „SNACKHOLDER“**

greaseproof paper squares
papel alimenticio para cucurucho
papier alimentaire pour cornet

	cm	pcs.		€
40670	42 x 25	500	Motiv: Zeitung	57,00
40671	42 x 25	500	blank	31,00
	cm	pcs.		€
40672	42 x 25	500	Motiv: rote Karos / red	57,00
40673	42 x 25	500	Motiv: blaue Karos / blue	57,00
40674	30 x 20	500	Motiv: Fast Food / black	37,00



40672



40673

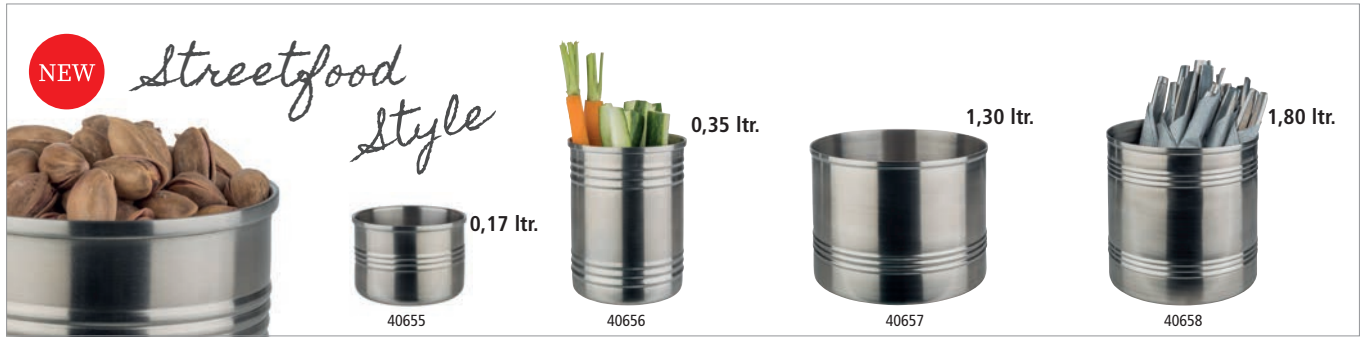

40674

**Snackcan**

serving can

bote para aperitivos

boîte pour apéritifs



	∅ cm	↑ cm	ltr.	€
40655	7,5	5,5	0,17	2,60
40656	7,5	10,0	0,35	3,20
40657	13,5	10,5	1,30	7,40
40658	13,5	14,0	1,80	8,00

**Schale**

bowl

cuenco

bol



	∅ cm	↑ cm	ltr.	€
40685	6	3,0	0,05	2,00
40686	8	4,5	0,17	3,00

**Schale**

bowl

cuenco

bol



gehämmerte Oberfläche / hammered surface / superficie martillada / surface martelée

	∅ cm	↑ cm	ltr.	€
40185	9,5	3	0,15	3,60

**Serviertöpfchen**

small serving pot

olla pequeña de servir

marmite petite de servir



gehämmerte Oberfläche

hammered surface

superficie martillada

surface martelée

	∅ cm	↑ cm	ltr.	Griff / handle	€
40186	9,5	5,5	0,30	2,5	7,40
40187	13,5	5,0	0,55	3,0	8,40
40188	15,5	5,0	0,75	3,0	10,00



Schale

bowl
cuenco
bol



gehämmerte Oberfläche
hammered surface
superficie martillada
surface martelée

	cm	↑ cm	ltr.	Farbe / Colour	€
40690	15,5 x 12,0	5,5	0,7	gold look	12,00
40693	23,0 x 15,5	6,0	1,4	gold look	18,00



Schale

bowl
cuenco
bol



gehämmerte Oberfläche
hammered surface
superficie martillada
surface martelée

	cm	↑ cm	ltr.	Farbe / Colour	€
40691	15,5 x 12,0	5,5	0,7	copper look	12,00
40694	23,0 x 15,5	6,0	1,4	copper look	18,00



Schale

bowl
cuenco
bol



gehämmerte Oberfläche
hammered surface
superficie martillada
surface martelée

	cm	↑ cm	ltr.	Farbe / Colour	€
40692	15,5 x 12,0	5,5	0,7	gunmetal-look	12,00
40695	23,0 x 15,5	6,0	1,4	gunmetal-look	18,00



Servierkorb „BURGER & FRIES“

serving basket
cesta para servir
corbeille de service



Servierkorb aus Metall mit 2 Halter für Dipschälchen
metal serving basket with 2 holders for dip bowls
cesta de metal para servir con 2 soportes para cuencos para dip
corbeille de service en métal avec 2 supports pour ramequins

	cm	↑ cm	€
40604	39,5 x 20	11	7,60

passende Schälchen / fitting bowls / cuencos adecuados / bols apropiés



	ø cm	↑ cm	ltr.	VE / unit	€ / pc.
83781	7	3,7	0,05	24	1,20

Servierbeispiel - Lieferung ohne Schälchen
delivery without bowls

ENAMELWARE



40664

Teller „ENAMELWARE“

plate
plato
assiette



	Ø cm	↑ cm	Farbe / Colour	€
40664	20	2		flacher Teller 5,80
40665	24	2		flacher Teller 6,60
40666	26	2		flacher Teller 7,00



40662

Teller „ENAMELWARE“

plate
plato
assiette



	Ø cm	↑ cm	Farbe / Colour	€
40661	18	3,5		tiefer Teller 7,20
40662	22	3,5		tiefer Teller 7,70
40663	24	3,5		tiefer Teller 8,50



40668

Schale „ENAMELWARE“

bowl
cuenco
bol



	cm	↑ cm	ltr.	Farbe / Colour	€
40667	16 x 12,0	3,5	0,20		7,20
40668	18 x 13,5	4,0	0,35		7,60



Schale „ENAMELWARE“

bowl
cuenco
bol



	cm	↑ cm	ltr.	Farbe / Colour	€
40669	28 x 23	4,5	1,9		13,00

**Henkelbecher „ENAMELWARE“**

beaker
vaso coctelero
bol mélangeur



	Ø cm	↑ cm	ltr.	Farbe / Colour	€
40636	7	5	0,10		5,20
40632	9	8	0,35		6,00
40637	10	9	0,50		7,40

**Henkelbecher „ENAMELWARE“**

beaker
vaso coctelero
bol mélangeur



	Ø cm	↑ cm	ltr.	Farbe / Colour	€
40633	9	8	0,35		6,00

**Henkelbecher „ENAMELWARE“**

beaker
vaso coctelero
bol mélangeur



	Ø cm	↑ cm	ltr.	Farbe / Colour	€
40634	9	8	0,35		6,00

**Henkelbecher „ENAMELWARE“**

beaker
vaso coctelero
bol mélangeur



	Ø cm	↑ cm	ltr.	Farbe / Colour	€
40635	9	8	0,35		6,00

**Schale „ENAMELWARE“**

bowl
cuenco
bol



	Ø cm	↑ cm	ltr.	Farbe / Colour	€
40645	7,0	4,5	0,08		4,30
40646	8,0	3,5	0,08		4,30
40638	13,0	6,0	0,50		6,60
40647	16,5	4,5	0,45		5,50

Original Weck



Weck-Flaschen, 6er Set

Weck-bottles
Weck-botellas
Weck-bouteilles



6 Flaschen + 6 Deckel, ideal zum Servieren von Saft, Smoothie, Dressing und Saucen

6 bottles + 6 covers, ideal for serving juice, smoothie, dressing and sauces

6 botellas + 6 tapas, ideal para servir zumo, licuado, aliño y salsas

6 bouteilles + 6 couvercles, idéal pour servir de jus, smoothie, vinaigrette et sauces

	Ø cm	↑ cm	ltr.	pcs	€
82307	6	14,5	0,25	6	10,90



Weck-Flaschen, 6er Set

Weck-bottles
Weck-botellas
Weck-bouteilles



6 Flaschen + 6 Deckel, ideal zum Servieren von Saft, Smoothie, Dressing und Saucen

6 bottles + 6 covers, ideal for serving juice, smoothie, dressing and sauces

6 botellas + 6 tapas, ideal para servir zumo, licuado, aliño y salsas

6 bouteilles + 6 couvercles, idéal pour servir de jus, smoothie, vinaigrette et sauces

	Ø cm	↑ cm	ltr.	pcs	€
82308	6	19	0,5	6	12,10



Weck-Flaschen, 6er Set

Weck-bottles
Weck-botellas
Weck-bouteilles



6 Flaschen + 6 Deckel, ideal zum Servieren von Saft, Smoothie, Dressing und Saucen

6 bottles + 6 covers, ideal for serving juice, smoothie, dressing and sauces

6 botellas + 6 tapas, ideal para servir zumo, licuado, aliño y salsas

6 bouteilles + 6 couvercles, idéal pour servir de jus, smoothie, vinaigrette et sauces

	Ø cm	↑ cm	ltr.	pcs	€
82309	6	25,5	1,0	6	14,20



Tulpenform

Weck-Gläser mit Deckel, 12er Set

Weck-glasses with lid
Weck tarros de vidro con tapa
Weck verrines avec couvercle

**12 Gläser + 12 Deckel**

12 glasses + 12 covers
12 vasos + 12 tapas
12 verrines + 12 couvercles

	Ø cm	↑ cm	ltr.	pcs	€
82316	7	8,0	0,22	12	19,70



Sturzform

Weck-Gläser mit Deckel, 12er Set

Weck-glasses with lid
Weck tarros de vidro con tapa
Weck pots en verre avec couvercle

**12 Gläser + 12 Deckel**

12 glasses + 12 cover
12 vasos + 12 tapas
12 verrines + 12 couvercles

	Ø cm	↑ cm	ltr.	pcs	€
82345	9	6	0,20	12	19,70



Sturzform

Weck-Gläser mit Deckel, 3er Set

Weck-glasses with lid, 3 pcs.
Weck tarros de vidro con tapa, set de 3
Weck verrines avec couvercle, set de 3

**3 Gläser + 3 Deckel**

3 glasses + 3 covers
3 vasos + 3 tapas
3 verrines + 3 couvercles

	Ø cm	↑ cm	ltr.	pcs	€
82346	11	7,5	0,37	3	6,10



Sturzform

Weck-Gläser mit Deckel, 2er Set

Weck-glasses with lid, 2 pcs.
Weck tarros de vidro con tapa, set de 2
Weck verrines avec couvercle, set de 2

**2 Gläser + 2 Deckel**

2 glasses + 2 covers
2 vasos + 2 tapas
2 verrines + 2 couvercles

	Ø cm	↑ cm	ltr.	pcs	€
82347	11	11	0,58	2	5,40

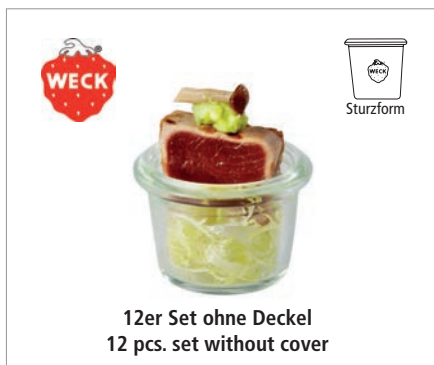

Sturzform

Gourmetgläser, 12er Set

gourmet glasses, 12 pcs.
tarros gourmet, set de 12
verres gourmet, set de 12



	Ø cm	↑ cm	ltr.	pcs	€
82359	5	3,5	0,035	12	8,20
82370	6	5,5	0,08	12	11,00
82371	6	8,0	0,16	12	11,70

12er Set ohne Deckel
12 pcs. set without cover

**Weck-Gläser mit Deckel, 12er Set**

Weck-glasses with lid
Weck tarros de vidro con tapa
Weck verrines avec couvercle

**12 Gläser + 12 Deckel**

12 glasses + 12 covers

12 vasos + 12 tapas

12 verrines + 12 couvercles

	Ø cm	↑ cm	ltr.	pcs	€
82310	6	5,5	0,08	12	18,00
82312	6	7,0	0,14	12	19,70
82314	6	8,0	0,16	12	19,70

**Serviergestell „WECK“**

serving stand
expositor
présentoir

ohne Gläser

without glasses

sin vasos

sans verrines



	Ø cm	↑ cm		€
33246	22	59	12 x Ø 6 cm	85,00

**Serviergestell „WECK“**

serving stand
expositor
présentoir

ohne Gläser

without glasses

sin vasos

sans verrines



	Ø cm	↑ cm		€
33247	22	33	6 x Ø 6 cm	54,00

**Weck-Frischhalte-Deckel, 5er Set**

airtight cover, 5 pcs.
tapa hermética, set de 5
couvercle hermétique, set de 5

**für Rundrandgläser Ø 6 cm, 5er Set**

for Ø 6 cm glasses, 5 pcs. set
para vasos Ø 6 cm, set de 5
pour verrines Ø 6 cm, set de 5

	Ø cm	pcs	€
82338	7	5	2,30

**10er Set Gummidichringe**

10 pcs. rubber washer
10 juntas de goma
10 joints de caoutchouc

für Deckel der Weck-Gläser, im Beutel verpackt

for covers of Weck-glasses
para las tapas de los tarritos Weck
pour la fermeture des verrines Weck

	fits to	€
82318	82307, 82308, 82309, 82310, 82312, 82314, 82316	1,20
82394	82345	1,20
82395	82346, 82347	1,30

**8er Set Deckel-Klammer für 4 Weck-Gläser**

8 pcs. cover clamps for 4 Weck-glasses
8 abrazaderas para 4 vasitos Weck
8 agrafes pour 4 verrines Weck



	€
82319	2,30



Topf darf nicht erhitzt werden!
Topf ist nicht zum Kochen geeignet!

Muscheltopf

mussel pot
mejillonera
casserole à moules

schwarz emailliertes Stahlblech, mit Edelstahlrand

black enamelled steel, stainless steel rim
hierro esmaltado negro, borde inox
acier émaillé noir, bord inox



	Ø cm	↑ cm	Topf / pot ltr.	Deckel / lid ltr.	€
00623	13,5	9,0	0,75	0,60	6,30
00625	18,0	12,0	2,60	1,40	10,50
00626	20,0	13,0	3,30	1,60	11,60
00627	24,0	13,5	5,20	2,70	12,60

**Schale „OLIVE“**bowl
cuenco
bolaus geöltem Olivenholz
oiled olive wood
de madera de olivo aceitada
en bois d'olivier huilé

	cm	↑ cm	ltr.	€
00843	12,0 x 7,5	2,5	0,05	7,00
00844	16,5 x 9,5	2,5	0,10	9,00

**Schale „OLIVE“**bowl
cuenco
bolaus geöltem Olivenholz
oiled olive wood
de madera de olivo aceitada
en bois d'olivier huilé

	cm	↑ cm	ltr.	€
00907	13 x 8	6,5	0,20	6,00
00908	16 x 9	7,0	0,30	9,00

**Servierbrett „OLIVE“**serving board
tabla de servir
planche de serviceaus geöltem Olivenholz
oiled olive wood
de madera de olivo aceitada
en bois d'olivier huilé

	cm	↑ cm	€
00905	25,5 x 16,5	1,5	9,90
00906	35,0 x 20,5	1,5	19,00

**Servierbrett „NARROW“**serving board
tabla de servir
planche de serviceAkazienholz, mit 3 Vertiefungen Ø 6 cm
acacia wood, with 3 notches Ø 6 cm
madera de acacia, con 3 ranuras Ø 6 cm
bois d'acacia, avec 3 encoches Ø 6 cm

	cm	↑ cm	€
00878	31 x 11	2	10,00

passende Schälchen / fitting bowls / cuencos adecuados / bols apropiés



	Ø cm	↑ cm	ltr.		€
40685	6	3	0,05	stainless steel	2,00
82316	7	8	0,22	glas	19,70



Servierbrett „SHARING“

serving board
 tabla de servir
 planche de service



Servierbrett aus geöltem Akazienholz
 serving board made of oiled acacia wood
 tabla de servir de madera de acacia aceiteada
 planche en bois d'acacia huilé

	cm	↑ cm	Griff / handle cm	€
00887	51,5 x 18	1,5	8,5	29,00



Servierbrett „AKAZIE-SCHIEFER“

serving board
 tabla de servir
 planche de service

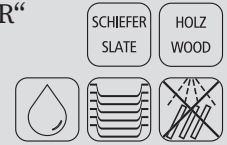

raffiniertes, rustikales Servierbrett
 aus Akazienholz, ausgestattet mit einem Naturschieferstreifen
 zur Kennzeichnung

wood with slate, markable
 madera con pizarra, se puede marcar
 bois avec ardoise, on peut mettre une inscription

	cm	↑ cm	€
00867	30,5 x 13	1,5	16,00
00868	36,5 x 15	1,5	20,00
00869	42,0 x 18	1,5	23,00



Servierbrett „OLIVE“

serving board
 tabla de servir en madera de olivo
 planche de service en bois d'olivier



Servierbrett im Naturschnitt, aus Olivenholz. Jedes Brett wird handgefertigt und geölt mit 19 mm Aufhäng Bohrung. Alle Produkte unterscheiden sich naturbedingt in Form, Maserung und Größe!

Olive Wood is known for its versatility and striking appearance with each piece having its own unique features.

El olivo es conocido por su versatilidad y aspecto espectacular y único en cada pieza. Por su fabricación a mano de forma artesanal, todas las piezas varían en tamaño, forma y acabado, lo que hace de cada una un ejemplar único.

Le bois d'olivier est reconnu pour sa versatilité et son esthétique spectaculaire. De par leur fabrication artisanale à la main, toutes les pièces varient quant à leur taille, forme et finition, de telle sorte que chacune est un exemplaire unique.

	cm	↑ cm	Griff / handle cm	€
00870	25,0 x 17,0	1,5		28,00
00871	30,0 x 20,5	2,0		46,00
00872	35,0 x 24,0	2,0		56,00
00873	40,0 x 15,0	1,5	11	49,00
00874	44,0 x 20,0	2,0	12	64,00
00875	19,0 x 12,5	1,5	6	20,00
00876	25,0 x 16,0	1,5	8	30,00
00877	31,0 x 20,0	1,5	9	46,00

NEW



mit Absatz Ø 5 cm
with hole Ø 5 cm

Servierbrett, 2-tlg.

serving board, 2 pcs. set
tabla de servir, set de 2
planche de service, set de 2

SCHIEFER
SLATEHOLZ
WOOD**2-teilig:**

1 Holzbrett aus Akazienholz + 1 Naturschieferplatte

1 wood board made of acacia wood + 1 natural slate tray

1 tabla de madera de acacia + 1 pizarra natural

1 planche en bois d'acacia + 1 ardoise naturelle

	cm	↑ cm	€
00814	28 x 17,5	2	14,00

NEW



00897



00898



00899

Servierbrett

serving board
tabla de servir
planche de service

HOLZ
WOOD

Servierbrett aus geöltem Akazienholz

serving board made of oiled acacia wood

tabla de servir de madera de acacia aceiteada

planche en bois avec plateau en bois d'acacia huilé

	cm	↑ cm	€
00897	30 x 15	2	12,00
00898	30 x 18	2	14,00
00899	35 x 25	2	20,00

NEW



00810



00811



00812



00813

Servierbrett, 2-tlg.

serving board, 2 pcs. set
tabla de servir, set de 2
planche de service, set de 2

SCHIEFER
SLATEHOLZ
WOOD**2-teilig:**

Ein rustikales Servierbrett aus Akazienholz,

ausgestattet mit einer Naturschieferplatte

wood board oiled acacia with a slate tray

tabla de madera de acacia con una bandeja de pizarra natural

planche en bois d'acacia avec un plateau en ardoise naturelle

	cm	↑ cm	€
00810	26 x 18	2	13,00
00811	33 x 20	2	16,00
00812	40 x 15	2	21,00
00813	43 x 12	2	16,00

Präsentationsmöglichkeit
presentation example



00813

mit Hängeloch Ø 2 cm / with a handle-hole Ø 2 cm



Servierbrett „OAK“

serving board
tabla de servir
planche de service



aus geöltem Eichenholz, Safrille, ø 9,5 cm runde Aussparung

made of oiled oak, with juice groove, with hole ø 9.5 cm

de madeira de roble aceiteada, con ranura para liquidos, con agujero ø 9,5 cm

en bois chêne huilé, avec rigole, avec trou ø 9,5 cm

	cm	↑ cm	€
00808	37 x 25	2	22,00



mit Safrinne / with juice groove



Holzbox „TABLE“

woodbox
caja madera
base bois



Akazienholz, 3 Fächer (6,5 x 6,5 cm)

acacia wood, 3 compartments (6,5 x 6,5 cm)

madera de acacia, 3 compartimentos (6,5 x 6,5 cm)

bois d'acacia, 3 compartiments (6,5 x 6,5 cm)

	cm	↑ cm	inner size cm	€
11727	23,5 x 8,5	4,5	6,5 x 6,5 je Fach / each compartment	12,00

Servierbeispiel - Lieferung ohne Gläser
delivery without glasses



Holzbox „VINTAGE“

woodbox
caja madera
base bois



Akazienholz, vintage weiß

acacia wood, vintage white

madera de acacia, blanca vintage

bois d'acacia, blanc vintage

	cm	↑ cm	inner size cm	€
11725	15 x 9,5	5	12 x 6,5	9,00

für ca. 20 Teebeutel



Holzbox „TABLE“

woodbox
caja madera
base bois



Akazienholz, natur

acacia wood, nature

madera de acacia, natural

bois d'acacia, naturel

	cm	↑ cm	inner size cm	€
11726	15 x 9,5	5	12 x 6,5	9,00



00895

00896

Rindenholzbrett „NATURA“

wood plater

tabla de madera con corteza

planche en bois avec écorce

**Akazienholz mit Rinde, jedes Brett ein Unikat, vor dem Erstgebrauch mit Speiseöl behandeln**

acacia wood with bark, each board unique, treat with cooking oil before first use

madera de acacia con corteza, cada tabla un ejemplar único,

tartar con aceite de cocina antes del primer uso

bois d'acacia avec écorce, chaque planche une modèlle unique,

traiter avec de l'huile de cuisson avant la première utilisation

	cm	↑ cm	€
00895	26,0 x 24,0	2	13,00
00896	30,0 x 28,5	2	15,00

**Besteckbehälter „TIN“**

cutlery bin

recipiente

récipient

**Behälter aus Metall mit Tragegriff aus Holz**

container made of metal with wooden handle

contenedor de metal con asa de madera

conteneur métallique avec poignée en bois

	cm	↑ cm	€
00014	24,5 x 12	18,5	8,90



82316

passende Gläser:
82310, 82312, 82314,
82316

Naturschieferplatte

natural slate tray

bandeja pizarra natural

plat ardoise naturelle

**mit Absatz Ø 6 cm**

with hole Ø 6 cm

con agujero Ø 6 cm

avec trou Ø 6,0 cm

	cm	* mm	€
00986	25 x 12	6 - 9	3,90



passende Gläser:
82310, 82312, 82314,
82316

Naturschieferplatte

natural slate tray

bandeja pizarra natural

plat ardoise naturelle

**mit 3 Absätzen, Ø 6 cm**

with 3 holes, Ø 6 cm

con 3 agujeros, Ø 6 cm

avec 3 trous, Ø 6 cm

	cm	* mm	€
00987	28 x 10	6 - 9	5,40

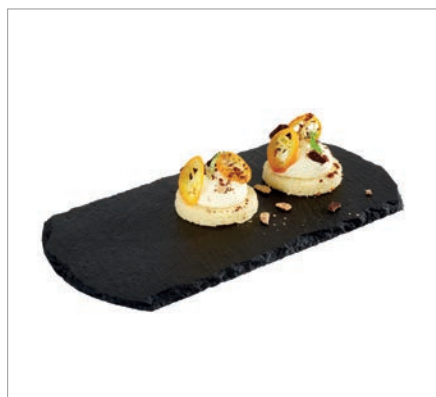
**Naturschieferplatte „STARTER“**

natural slate tray
bandeja de pizarra natural
plat ardoise naturelle carré



	cm	✦ mm	€
00937	20 x 10	6 - 9	2,90

**Weck-Glas 82316****Naturschieferplatte / Untersetzer**

natural slate tray
bandeja de pizarra natural
plateau ardoise naturelle



mit 2 Absätzen Ø 6 cm
with 2 holes Ø 6 cm
con 2 agujeros Ø 6 cm
avec 2 trous Ø 6 cm

	cm	✦ mm	€
00971	15 x 8	6 - 9	3,00

**Naturschieferplatte, 2-teilig**

natural slate tray, 2 pcs. set
bandeja de pizarra natural y campana
plateau ardoise naturelle et cloche en verre
mit Glashaube



with glass cover
con tapa de cristal
avec cloche en verre

	∅ cm	↑ cm	✦ mm	€
00984	10,5	8	6 - 9	8,00

**Naturschieferplatte**

natural slate tray
bandeja de pizarra natural
plat ardoise naturelle



	cm	✦ mm	€
00996	45 x 30	6 - 9	12,00

**Naturschieferplatte**

natural slate tray
bandeja de pizarra natural
plat ardoise naturelle



	cm	✦ mm	€
00994	25 x 25	6 - 9	6,00
00995	30 x 30	6 - 9	9,00

**Konditorplatte**

cake stand
soporte para pastel
présentoir à gâteaux

matt poliert
satin polished finish
acabado efecto satinado
poli mat effet satin



	Ø cm	↑ cm	€
00046	31	3	12,50

**Servier- / Tortenplatte**

cake stand
soporte para pastel
présentoir à gâteaux

Fuß hochglanzpoliert, Platte matt poliert, stabil und sehr standsicher
foot mirror polished finish, plate satin polished finish
pie pulido brillante, bandeja pulida mate
pied brillant, plateau poli satin mat



	Ø cm	↑ cm	€
00462	30	11	42,00

**Servier- / Tortenplatte**

cake stand
soporte para pastel
présentoir à gâteaux

matt poliert, drehbar, möbelschonende Moosgummi-Unterseite
satin polished finish, rotating, foam rubber below to save your furniture
acabado pulido satinado, giratorio, base revestida de goma para no rallar el mobiliario
poli satiné, plateau tournant, revêtement mousse sous le pied pour ne pas rayer les meubles



	Ø cm	↑ cm	€
00463	30,5	9	38,00

**Servier- / Tortenplatte**

cake stand
soporte para pastel
présentoir à gâteaux

Fuß matt poliert, stabil und sehr standsicher, möbelschonende Moosgummi-Unterseite
foot satin polished finish, foam rubber below to save your furniture
pie pulido con efecto satinado, base revestida de goma para no rallar el mobiliario
inox poli satin, revêtement mousse sous le pied pour ne pas rayer les meubles

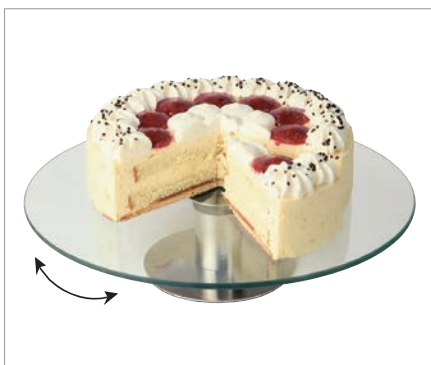

	Ø cm	↑ cm	€
00464	30	11	18,50

**Servier- / Tortenplatte**

cake stand
soporte para pastel
présentoir à gâteaux

Fuß matt poliert, drehbar, möbelschonende Moosgummi-Unterseite
foot satin polished finish, rotating, foam rubber below to save your furniture
vidrio, pie inox satinado giratorio, base de goma para proteger el mobiliario
plateau en verre, pied tournant inox poli satin, revêtement mousse sous le pied anti-rayures



	Ø cm	↑ cm	€
00444	30	7	18,90



Torten- / Konditorplatte „SLATE“

cake stand
soporte para pastel
présentoir à gâteaux

Rand fixiert die Haube, mit Antirutsch-Füßchen

carved edge fixes the cover, with non-slip feet

ranura para fijar bien la campana, con pies antideslizantes

bord rainuré pour maintenir ferme la cloche, avec pieds antidérapants



	Ø cm	↑ cm	passende Haube / suitable cover / campana adecuada / cloche appropriée	€
85046	21,5	2,5	06519 NEW	13,00
85047	30,5	3,5	06520, 06512	18,00
85048	37,5	4,0	06521 NEW	34,00



Torten- / Konditorplatte „LOOPS“

cake stand
soporte para pastel
présentoir à gâteaux



	Ø cm	↑ cm	passende Haube / suitable cover / campana adecuada / cloche appropriée	€
85033	21,5	2,5	06519 NEW	13,00
85034	30,5	3,5	06520, 06512, 06510	18,00
85035	37,5	4,0	06521 NEW	34,00



Torten- / Konditorplatte

cake stand
soporte para pastel
présentoir à gâteaux

Rand fixiert die Haube, mit Antirutsch-Füßchen

carved edge fixes the cover, with non-slip feet

ranura para fijar bien la campana, con pies antideslizantes

bord rainuré pour maintenir ferme la cloche, avec pieds antidérapants



	Ø cm	↑ cm	Farbe / Colour	€
85044	21,5	2,5	White	12,00
00468	31,0	3,5	White	15,00
85045	37,5	4,0	White	32,00
00469	31,0	3,5	Black	15,00



Servier- und Tortenplatte „CASUAL“

cake plate
porta pasteles
présentoir à gâteaux



	Ø cm	↑ cm	€
83890	31	8	24,00
83891	31	16	30,00



Servier- und Tortenplatte „CASUAL“

cake plate
porta pasteles
présentoir à gâteaux



	cm	↑ cm	€
83892	31 x 31	8	27,00
83893	31 x 31	16	32,50

NEW

CLASSIC



Servier- und Tortenplatte „CLASSIC“

cake stand
porta pasteles
présentoir à gâteaux

Rand fixiert die Haube
carved edge fixes the cover
ranura para fijar bien la campana
bord rainuré pour maintenir ferme la cloche



	Ø cm	↑ cm	€
85049	21,5	9	19,00
85050	21,5	17	25,00
85051	30,5	9	28,00
85052	30,5	17	34,00
85053	37,5	9	36,00
85054	37,5	17	42,00

Frischhalte- Haube / cover / campana / cloche



	Ø cm	↑ cm	fits to	€
06519 <small>NEW</small>	21	17	85049, 85050	24,00
06520	30	22	85051, 85052	29,90
06521 <small>NEW</small>	36	27	85053, 85054	56,00

Frischhalte- Haube / cover / campana / cloche



	Ø cm	↑ cm	fits to	€
06512	30	11,5	85051, 85052	6,20



Servier- und Tortenplatte „ACACIA MINI“
 cake stand
 porta pasteles
 présentoir à gâteaux

Akazienholz geölt
 acacia wood oiled
 mader de acacia aceiteada
 bois d'acacia huilé

	Ø cm	↑ cm	€
33290	9,5	7	12,00
33291	13,0	9	16,00



Servier- und Tortenplatte „ACACIA“
 cake stand
 porta pasteles
 présentoir à gâteaux

Akazienholz geölt
 acacia wood oiled
 mader de acacia aceiteada
 bois d'acacia huilé

	Ø cm	↑ cm	€
33292	24,0	8	39,00
33293	24,0	16	49,00
33294	33,0	8	54,00
33295	33,0	16	74,00
33296	38,5	8	66,00
33297	38,5	16	89,00

Frischhalte- Haube / cover / campana / cloche

	Ø cm	↑ cm	fits to	€
06519	21	17	33292, 33293	24,00
06520	30	22	33294, 33295	29,90
06521	36	27	33296, 33297	56,00

**Kaviarkühler**

caviar cooler
enfriador de caviar
rafraîchisseur de caviar



4-teilig: Glasschale Ø 10 cm

4 pcs.: glass bow Ø 10 cm

set de 4: bol Ø 10 cm

set de 4: bol Ø 10 cm

	Ø cm	↑ cm	€
01699	18	12	49,90



75001
Spießständer
skewer rack

75002
Spieße
skewer

Spießständer / Spieße

espetada and kebab skewer rack / skewer
soporte para brochetas
support pour brochettes



zum Servieren von Fleischspießen bis 40 cm, Gestell aus 8 mm Edelstahl

to serve skewers up to 40 cm, wire stainless steel 8 mm

para servir brochetas de carne hasta 40 cm, grosor del alambre 8 mm, inox

pour présenter les brochettes long. maxi 40 cm, fil 8 mm, inox

	Ø cm	↑ cm	€
75001	22,0	46	33,00
75002	0,3	40	4er Set / 4 pcs. set 8,00



15925

15926

Butterservierer

butter dish
mantequillera
beurrer



	cm	↑ cm	€
15925	Ø 9	9	7,00
15926	9 x 9	9	7,00

**Butterservierer**

butter dish
mantequillera
beurrer



hochglanzpoliert / mirror polished finish / acabado brillante / poli brillant

	Ø cm	↑ cm	€
15921	9	7	13,00

praktischer Ausgießer
easy pouring

**Butter- und Saucenwärmer**

butter and sauce pan warmer
calentador de mantequilla y salsa
réchaud à beurre et sauce



Saucentopf mit Ausgießer + Deckel + Gestell (passend für 1 Teelicht)

pan with spout + lid + riser (for 1 light)

cacerola + tapadera + soporte (para 1 vela)

petite casserole avec bec verseur + couvercle + support (pour 1 bougie)

	Ø cm	↑ cm	ltr.	€
35350	14	16	0,7	Griff: 13,5 cm / handle: 13,5 cm asa: 13,5 cm / poignée: 13,5 cm 15,00

**Sauciere**

gravy boat
salsera
saucière



hochglanzpoliert, extra schwere Qualität

mirror polished finish, high quality

acabado efecto espejo, alta calidad, base pesada

poli brilhant, belle qualité, pied pesant

	cm	↑ cm	ltr.	€
40208	13 x 6,0	9,0	0,075	6,00
40204	16 x 7,5	9,0	0,125	7,00
40205	19 x 9,0	13,0	0,25	9,00
40206	22 x 10,5	13,5	0,4	11,00

**Sauciere**

gravy boat
salsera
saucière



poliert

polished

pulido

poli

	cm	↑ cm	ltr.	€
40200	18,0 x 7,5	7,0	0,10	4,60
40203	21,5 x 9,5	8,5	0,15	5,40
40201	23,5 x 10,0	10,0	0,20	5,60
40202	23,5 x 12,0	12,0	0,45	6,70

**Thermo-Sauciere**

insulated sauce boat
salsera isotérmica
saucière thermique



doppelwandig, Klappdeckelverschluss, Einhandbedienung

double wall, hinged cover, one-hand operation

doble pared, tapa con bisagra, se maneja con 1 mano

double paroi, couvercle avec charnière, usage 1 main

	cm	↑ cm	ltr.	€
40207	19 x 12,5	13	0,4	14,00



Gourmet-Löffel „GUN-METAL“

party spoon
cuchara gourmet
cuillère gourmet



	→ cm			€
00693	12	schwarz / gunmetal look	PVD coated stainless steel	5,20



Gourmet-Löffel „CLASSIC“

party spoon
cuchara gourmet
cuillère gourmet



	→ cm			€
00677	13,5	Edelstahl-Look / stainless steel look		2,40
00691	12,0	Gold-Look / gold look	PVD coated stainless steel	5,20
00692	12,0	Kupfer-Look / copper look	PVD coated stainless steel	5,20



Stielkasserolle / Serviertopf

sauté pan / mini sauce pan
cazo recto bajo
plat à sauter



	Ø cm	↑ cm	ltr.		€
40642	5,5	2,5	0,05	Griff: 6 cm / handle: 6 cm asa: 6 cm / poignée: 6 cm	4,40
40643	7,0	3,5	0,12	Griff: 8,5 cm / handle: 8,5 cm asa: 8,5 cm / poignée: 8,5 cm	5,00
40644	9,5	5,5	0,32	Griff: 8,5 cm / handle: 8,5 cm asa: 8,5 cm / poignée: 8,5 cm	7,90

**Glocke**

cloche / dome cover
campana esférica
cloche demi-sphère



außen hochglanzpoliert, innen matt poliert, mit verchromten Griff

outside mirror polished finish, inside satin polished finish, with chromeplated handle
exterior pulido acabado efecto espejo, interior pulido acabado efecto satinado, pomo cromado
extérieur poli brillant, intérieur poli satin, buton chromé

	Ø cm	↑ cm	€
35734	29	18	44,00

**Platzteller**

plate tray
bajo plato
assiette de présentation



Rand eingerollt

rolled edge
borde redondeado
bord rond

	Ø cm	€
35735	31	15,00

**Platzteller**

plate tray
bajo plato
assiette de présentation



hochglanzpoliert, mit Fadendekor

mirror polished finish, with line edge
pulido efecto espejo, con un filo en relieve
poli miroir, filet relief

	Ø cm	€
35730	30,5	14,40
36233	33,0	19,20

**Platzteller**

plate tray
bajo plato
assiette de présentation



hochglanzpoliert, mit Perlrand

mirror polished finish, with pearl edge
acabado pulido efecto espejo, con borde aperlado
poli miroir, bord perlé

	Ø cm	€
35720	30,5	14,60
36323	33,0	18,20

**Untersetzer, 6er Set**

coaster, 6 pcs. set
posavazos, set de 6
plateau sous-verre, set de 6

EDELSTAHL
STAINLESS
INOX
18/8



hochglanzpoliert, schwere Ausführung, Rand eingerollt

mirror polished finish, heavy quality, rolled edge

acabado pulido efecto espejo, alta calidad, borde redondeado

effet miroir, bord rond, qualité extra

	Ø cm	pcs.	€
35711	10	6	16,00
35912	12	6	13,90

**Serviettenringe, 6er Set**

napkin rings, 6 pcs. set
servilleteros, set de 6
anneaux à serviettes, set de 6

METALL
VERCHROMT

	cm	↑ cm	pcs.	€
04445	6,5 x 4	1	6	22,40

**Serviettenringe, 4er Set**

napkin rings, 4 pcs. set
servilleteros, set de 4
anneaux porte-serviette, set de 4

EDELSTAHL
STAINLESS
INOX



	Ø cm	↑ cm	pcs.	€
04446	4,5	2,5	4	7,40

**Besteckkorb „ECONOMIC“**

cutlery dispenser
dispensador de cubiertos
corbeille à couverts



in Handarbeit geflochten

wickerwork
trensado a mano
tressage à main

	Ø cm	↑ cm	Farbe / Colour	€
40130	12	15		3,40
40007	12	15		3,40
40012	12	15		3,40
40013	12	15		3,40

**Besteckkorb „ECONOMIC“**

cutlery dispenser
dispensador de cubiertos
corbeille à couverts



in Handarbeit geflochten

wickerwork
trensado a mano
tressage à main

	cm	↑ cm	Farbe / Colour	€
40131	27 x 10	4,5		3,40
40009	27 x 10	4,5		3,40
40010	27 x 10	4,5		3,40
40011	27 x 10	4,5		3,40

**Table Caddy „COUNTRY STYLE“**

table barrel
caddy de mesa
caddy de table



cooler Country-Style, nicht für den direkten Kontakt mit
Lebensmittel verwendbar

condiment and cutlery holders or even for food presentation, the
mini barrels should not come into contact with food, they should
be lined with our greaseproof paper

estilo campo, no aptos para el contacto directo con alimentos,
sólo usando papel alimenticio

de style champêtre, pas de contact direct avec aliments, seulement
en utilisant papier alimentaire

	Ø cm	↑ cm	€
11930	17,5	8,5	19,00
11931	11,5	14,0	19,00

**Besteckbehälter „ELEMENT“**

cutlery bin
recipiente para cubiertos
récipients pour couverts



mit Abflussloch, mit weißem Logo, Bodeneinlage aus Silikon zum Schonen des Bestecks, möbelschonende Unterseite
with drain hole, with white logo, silicone floor inserts for saving the cutlery, with non-scratching undersurface
con orificio de drenaje, con logotipo blanco, base de silicona para proteger la cuberteria, con base anti rayaduras
avec trou de drainage, avec logo blanc, insert de silicone pour proteger la coutellerie, avec revêtement antirayures

	Ø cm	↑ cm	Logo	€
11935	12	14	fork	14,50
11936	12	14	knife	14,50
11937	12	14	spoon	14,50

**Besteckbehälter „ACACIA“**

cutlery bin
recipiente para cubiertos
récipients pour couverts



Akazienholz natur
acacia wood nature
madera de acacia natural
bois d'acacia naturelle

	cm	↑ cm	Logo	€
11939	14 x 14	15	fork / knife / spoon	14,00

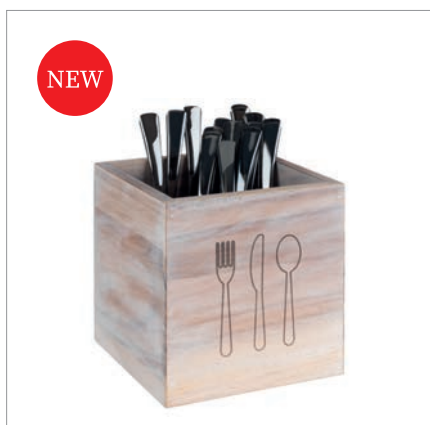
**Besteckbehälter „VINTAGE“**

cutlery bin
recipiente para cubiertos
récipients pour couverts



Akazienholz vintage weiß
acacia wood, vintage white
madera de acacia, blanca vintage
bois d'acacia, blanc vintage

	cm	↑ cm	Logo	€
11938	14 x 14	15	fork / knife / spoon	14,00

**Besteckbehälter „ELEMENT“**

cutlery bin
recipiente para cubiertos
récipients pour couverts



mit Abflussloch, mit Besteck Logo, Bodeneinlagen aus Silikon
zum Schonen des Bestecks, möbelschonende Unterseite

with drain hole, with cutlery logo, silicone floor inserts for saving the points of knives,
with non-scratching underside

con orificio de drenaje, con logotipo de cubertería, soporte de silicona para proteger
las puntas de los cuchillos, con base antirrayaduras

avec le trou de drainage, avec le logo de coutellerie, insert de silicone pour protéger
les pointes des couteaux, avec base revêtue antirayures

	Ø cm	↑ cm	€
00018	11	14	15,00

**Tischreste- / Besteckbehälter „TOP CHROME“**

table waste bin / cutlery bin
papelera de sobremesa / recipiente para cubiertos
poubelle de table / récipients pour couverts



mit verchromten Rand

with chrome plated ring

con anillo cromado

avec bord chromé

	Ø cm	↑ cm	ltr.	Farbe / Colour	€
00025	13	15	1	White	6,00
00026	13	15	1	Black	6,00

**Tischreste- / Besteckbehälter „BASE CHROME“**

table waste bin / cutlery bin
papelera de sobremesa / recipiente para cubiertos
poubelle de table / récipients pour couverts



mit verchromten Boden

with chrome bottom

con base cromada

avec base chromée

	Ø cm	↑ cm	ltr.	Farbe / Colour	€
00019	13	15	1,3	White	6,00
00020	13	15	1,3	Black	6,00

**Besteckköcher**

cutlery basket
cesta para cubiertos
corbeille à couverts



	Ø cm	↑ cm	€
11998	9,7	13,7	2,50
11999	9,7	13,7	7,90

11998

Köcher weiß

11999

Köcher Edelstahl

**Tischreste- / Besteckbehälter**

table garbage bin / cutlery bin
papelera de sobremesa / recipiente para cubiertos
poubelle de table / récipients pour couverts



matt poliert, mit abnehmbaren Lochdeckel

satin polished finish, with removeable cover

acabado pulido satinado, con tapa desmontable

poli mat satiné, avec couvercle démontable ouvert au centre

	Ø cm	↑ cm	ltr.	€
00028	10	12	0,7	12,00

**Tischrestebehälter**

table garbage bin
papelera de sobremesa
poubelle de table



matt poliert, abnehmbarer Schwingdeckel, mit Bajonettverschluss „fester Deckelsitz“

satin polished finish, swing cover, cover removable

acabado satinado, tapa basculante desmontable

poli mat satiné, couvercle basculant démontable

	Ø cm	↑ cm	ltr.	€
00029	12	17	1,2	16,00
00027	10	13	0,7	12,00

**Tischrestebehälter**

table garbage bin
papelera de sobremesa
poubelle de table



Behälter aus weiß lackiertem Metall, Edelstahl-Lochdeckel

metall white, stainless cover with hole

tapa, acero inoxidable, con apertura

couvercle inox, avec ouverture centrale, récipient en acier laqué blanc

	Ø cm	↑ cm	ltr.	€
00292	12	15	1,2	16,00

**Tischreste- / Besteckbehälter**

table waste bin / cutlery bin
papelera de sobremesa / recipiente para cubiertos
poubelle de table / récipients pour couverts



mit verchromten Rand, inkl. herausnehmbarem Einteiler (4 Fächer)

with chrome plated ring, incl. divider (4 chambers)

con anillo cromado

avec bord chromé

	cm	↑ cm	Farbe / Colour	€
00016	14 x 14	16	■	19,00

**Tischrestebehälter „SUNDAY“**

table waste bin
papelera de sobremesa
poubelle de table



matt poliert, inkl. Deckel, fester Deckelsitz

satin polished finish, incl. cover, cover removable

acero inoxidable mate, con tapa

inox mat, avec couvercle

	Ø cm	↑ cm	ltr.	€
00024	10	18	1,1	23,90



Tischrestehälter
table garbage bin
papelera de sobremesa
poubelle de table



	Ø cm	↑ cm	ltr.	Farbe / Colour	€
02038	11	14	0,9		2,60
02039	11	14	0,9		2,60



Tischrestehälter
table garbage bin
papelera de sobremesa
poubelle de table



	Ø cm	↑ cm	ltr.	€
00311	14	15	1,2	3,60



Tischrestehälter
table garbage bin
papelera de sobremesa
poubelle de table



Kunststoff weiß / granit, abnehmbarer Schwingdeckel
white plastic, swing cover, cover removable
plástico blanco/granito, tapa basculante desmontable
plastique blanc/gris chiné, couvercle basculant démontable

	Ø cm	↑ cm	ltr.	€
00031	12	18	1,4	5,40



Tischrestehälter „INTERNATIONAL“
table waste bin
papelera de sobremesa
poubelle de table



Deckel-Ring mit Dichtung, internationale Beschriftung
cover with sealing ring, internationale Beschriftung
tapa con junta, texto multi-idiomas
couvercle avec joint, texte multilingue

	Ø cm	↑ cm	ltr.	€
83847	10	17,5	1	9,00



Tischrestehälter
table garbage bin
papelera de sobremesa
poubelle de table



Behälter aus weiß lackiertem Metall, abnehmbarer Schwingdeckel
cover stainless steel bin metal, white, swing cover
tapa de acero inoxidable, recipiente chapa lacada blanca
couvercle inox basculant, récipient en acier laqué blanc

	Ø cm	↑ cm	ltr.	€
00291	12	17	1,2	16,00

**Besteckbehälter „TIN“**

cutlery bin
recipiente
réceptient



Behälter aus Metall mit Tragegriff aus Holz
container made of metal with wooden handle
contenedor de metal con asa de madera
conteneur métallique avec poignée en bois

	cm	↑ cm	€
00014	24,5 x 12	18,5	8,90

**Tischrestebehälter**

table garbage bin
papelera de sobremesa
poubelle de table



	Ø cm	↑ cm	ltr	€
83999	13 / 9	14	1,2	11,50

**Besteckköcher**

cutlery basket
cesta para cubiertos
corbeille à couverts



	cm	↑ cm	Farbe / Colour	€
84535	12 x 12	16		4,90
84536	12 x 12	16		4,90

**Besteckständer**

cutlery basket
cesta para cubiertos
égouttoir à couverts



	Ø cm	↑ cm	€
11921	10	10,0	7,40
11922	12	13,5	9,90



NEW

Mini Staffelei, 2 tlg.

easel mini, 2 pcs. set
caballete mini, set de 2
chevale mini, set de 2

HOLZ
WOOD

1 Ständer aus Akazienholz, 1 Schild kann senkrecht oder waagrecht verwendet werden
1 acacia wood stand, 1 sign can be used vertically or horizontally
1 soporte de madera de acacia, 1 el cartel se puede utilizar vertical u horizontalmente
1 support en bois d'acacia, 1 le panneau peut être utilisé verticalement ou horizontalement

	cm	↑ cm	€
71520	13,5 x 10,0	19	8,00



waagrecht / horizontal



senkrecht / vertical



71490 Kreide-Marker / chalk marker

Inhalt ohne Stift
content without pen
contenido sin bolígrafo
contenu sans stylo



NEW

Kartenhalter, 2 tlg.

menu holder, 2 pcs. set
soporte de tarjeta de menú, set de 2
porte-cartes de menu, set de 2

BETON
CONCRETE

ACRYL
ACRYLIC

1 Fuß aus Beton, 1 Menühalter aus Acryl
1 concrete base, 1 acrylic menu sign / holder
1 base de hormigón, 1 letrero de menú acrílico
1 socle en béton, 1 plaque de menu en acrylique

	cm	↑ cm	€
71496	11,5 x 4,5	10	12,00



NEW

Kartenhalter, 2 tlg.

menu holder, 2 pcs. set
soporte de tarjeta de menú, set de 2
porte-cartes de menu, set de 2

BETON
CONCRETE

ACRYL
ACRYLIC

1 Fuß aus Beton, 1 Menühalter aus Acryl
1 concrete base, 1 acrylic menu sign / holder
1 base de hormigón, 1 letrero de menú acrílico
1 socle en béton, 1 plaque de menu en acrylique

	cm	↑ cm	€
71497	15,5 x 6,5	26	19,00



NEW

Tischstation „RAIL“, 4 tlg.

table station, 4 pcs. set
estación de mesa, set de 4
station de table, set de 4

MF
MELAMINE

GLAS
GLASS

EDELSTAHL
STAINLESS
INOX

Set: 1 Ständer, 1 Salz-, 1 Pfefferstreuer, 1 Zuckerdosierer
set: 1 stand, 1 salt and 1 pepper mills, 1 sugar dispenser
set: 1 soporte, 1 salero y 1 pimentero, 1 azucarero
set: 1 support, 1 salière et 1 poivrière, 1 distributeur de sucre

	cm	↑ cm	Ersatzgläser / replacement lenses	€
40475	23 x 9	7,5	40509, 40438, 40439	29,00



inkl. Kartenhalter
incl. card holder

Seite / page 323, 332

**Kartenhalter, 4er Set**

table stands, 4 pcs. set
portatarjetas, set de 4
porte-cartes, set de 4



hochglanzpoliert, inkl. 20 schwarze Beschriftungskarten aus Polypropylen
mirror polished finish, incl. 20 black cards made of polypropylene
pulido brillante, incl. 20 tarjetas negras de polipropileno
poli miroir, incl. 20 étiquettes noires en polypropylène

	Ø cm	↑ cm	pcs.	Farbe / Colour	€
71510	5	10,5	4	stainless steel	19,00
71511	5	10,5	4	copper	22,00
71512	5	10,5	4	gunmetal	22,00

**Kartenhalter, 4er Set**

table stands, 4 pcs. set
portatarjetas, set de 4
porte-cartes, set de 4



hochglanzpoliert, inkl. 20 schwarze Beschriftungskarten aus Polypropylen
mirror polished finish, incl. 20 black cards made of polypropylene
pulido brillante, incl. 20 tarjetas negras de polipropileno
poli miroir, incl. 20 étiquettes noires en polypropylène

	Ø cm	↑ cm	pcs.	Farbe / Colour	€
71513	5	15,5	4	stainless steel	20,00
71514	5	15,5	4	copper	24,00
71515	5	15,5	4	gunmetal	24,00

**Kartenhalter, 4er Set**

table stands, 4 pcs. set
portatarjetas, set de 4
porte-cartes, set de 4



hochglanzpoliert, inkl. 20 schwarze Beschriftungskarten aus Polypropylen
mirror polished finish, incl. 20 black cards made of polypropylene
pulido brillante, incl. 20 tarjetas negras de polipropileno
poli miroir, incl. 20 étiquettes noires en polypropylène

	Ø cm	↑ cm	pcs.	Farbe / Colour	€
71516	5	20,5	4	stainless steel	22,00
71517	5	20,5	4	copper	26,00
71518	5	20,5	4	gunmetal	26,00

**Kartenhalter-Set**

card holder set
portatarjetas, set
porte-cartes, set



18-teilig: 6 Kartenhalter 4 x 2,5 cm + 12 Kunststoff-Beschriftungskarten 10 x 6 cm
18 pcs. set: 6 card holder 4 x 2,5 cm + 12 plastic cards of inscription 10 x 6 cm
set de 18: 6 soportes 4 x 2,5 cm + 12 tarjetas de plástico 10 x 6 cm
set de 18: 6 supports 4 x 2,5 cm + 12 étiquettes en plastique 10 x 6 cm

	cm	€
00022	4 x 2,5	12,00

**Beschriftungskarten, 10er Set**

designation cards, 10 pcs. set
tarjetas, set de 10
étiquettes, set de 10



	cm	✱ mm	€
00037	7,5 x 5	0,4	4,90

**Bankettkartenständer**

menu stand / table number
porta-etiqueta o carta de sobremesa
porte-étiquette de table, porte-menu, ou n° de table

hochglanzpoliert, schwere Qualität
mirror polished finish, heavy gauge
acero inoxidable de alta calidad
inox, belle qualité



	Ø cm	↑ cm	€
71460	7,5	18,5	8,00
71461	7,5	29	10,40
71462	7,5	46	11,50

**Tischkartenhalter, 4er Set**

table stands, 4 pcs. set
pinzas porta-etiquetas, set de 4
porte-étiquettes à pince, set de 4

hochglanzpoliert, schwerer Fuß, inkl. 20 weiße Beschriftungskarten
mirror polished finish, heavy food, incl. 20 white labels
acabado brillante, incluye 20 etiquetas en blanco
poli brillant, inclut 20 étiquettes blanches



	Ø cm	↑ cm	pcs.	€
00070	4	10	4	20,00

**Tischaufsteller, 10er Set**

table stands, 10 pcs. set
caballes de mesa, set de 10
chevalets de table, set de 10

Ecken abgerundet
corners rounded
esquinas redondeadas
coins arrondies



	cm	↑ cm	pcs.	€
00011	7,5 x 3,5	5	10	6,90
00012	10,5 x 6	6,5	10	7,90

**Kartenhalter, 2er Set**

card holder, 2 pcs. set
soporte de mesa, set de 2
support de table, set de 2

inkl. 40 Beschriftungskarten, durch Magnete einfach zusammenklappbar
incl. 40 cards, easily foldable with magnets
incluye 40 tarjetas, fácil de plegar, con imanes
inclut 40 étiquettes, fácil à plier, avec aimants



	cm	↑ cm	pcs.	€
00076	9 x 3	5,5	2	16,00

**Buffetschilder, 3er Set**

buffet signs, 3 pcs. set
 indicadores buffet, set de 3
 petits chevalets de buffet, set de 3



können mit einem wasserfesten Filzschreiber beschrieben werden
 can be marked with water-based felt markers
 pueden marcarse con rotuladores de agua
 écriture facile avec un feutre lavable à l'eau

	cm	↑ cm	pcs.	€
03610	12 x 6	6	3	15,00

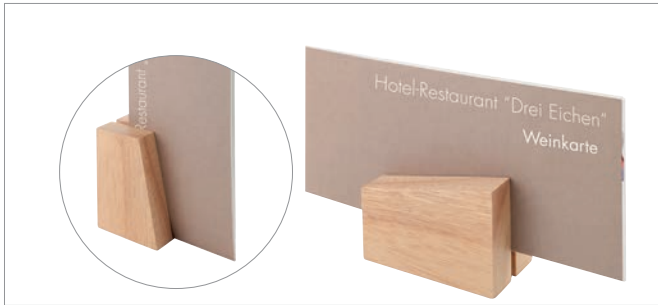
**Kartenhalter, 2er Set**

menu holder, 2 pcs. set
 porta cartas de mesa, set de 2
 supports pour menu de table, set de 2



	cm	↑ cm	pcs.	€
00023	8,5 x 6	4,5 / 8,5	2	7,50

**Kartenhalter, 2er Set**

menu holder, 2 pcs. set
 porta cartas de mesa, set de 2
 porte-menus de table, set de 2



matt poliert
 satin polished finish
 pulido satinado
 poli mat satiné

	cm	↑ cm	pcs.	€
00021	8,5 x 4	4 / 8,5	2	8,80

**Tischkartenhalter**

table stand
 soporte-carta para la mesa
 support pour menu de table



matt poliert
 satin polished finish
 pulido satinado
 poli mat satiné

	cm	↑ cm	pcs.	€
00030	8 x 7,0	2	1	2,80
00036	6 x 4,5	4	1	1,90

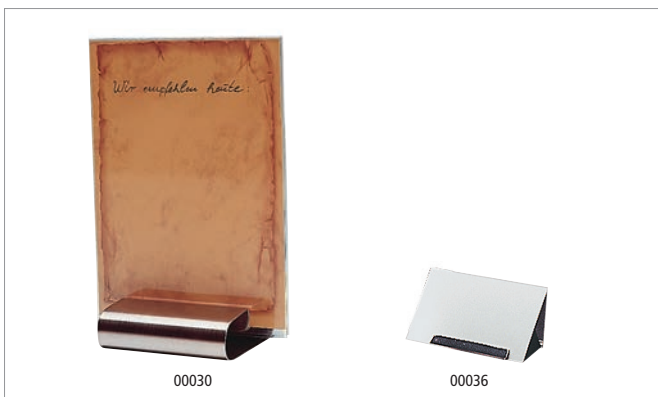
**Kartenhalter-Set, 4er Set**

table stands, 4 pcs. set
 portatarjetas, set de 4
 porte-cartes, set de 4



inkl. 30 Beschriftungskarten (15 x weiß + 15 x schwarz)
 incl. 30 labels (15 x white + 15 x black)
 incl. 30 tarjetas (15 x blanco + 15 x negro)
 incl. 20 étiquettes (15 x blanc + 15 x noir)

	cm	↑ cm	pcs.	€
71492	3 x 3	3	4	8,00
71493	3 x 3	3	4	8,00
71494	3 x 3	12	4	8,80

**Kartenhalter, 4er Set**

table stands, 4 pcs. set
soportes de mesa, set de 4
support de table, set de 4



inkl. 20 weiße Beschriftungskarten ca. 10 x 8 cm

incl. 20 white labels 10 x 8 cm

incluye 20 etiquetas blancas 10 x 8 cm

20 étiquettes blanches incluses 10 x 8 cm

	cm	↑ cm	pcs.	Farbe / Colour	€
00074	3 x 3	12	4		8,80

**Kartenhalter, 4er Set**

table stands, 4 pcs. set
soportes de mesa, set de 4
support de table, set de 4



inkl. 20 weiße Beschriftungskarten ca. 10 x 8 cm

incl. 20 white labels 10 x 8 cm

incluye 20 etiquetas blancas 10 x 8 cm

20 étiquettes blanches incluses 10 x 8 cm

	cm	↑ cm	pcs.	Farbe / Colour	€
00700	2,5 x 2,5	12	4		7,30

**Kartenhalter „WÜRFEL“, 4er Set**

table stands, 4 pcs. set
soporte de mesa, set de 4
porte-étiquettes, set de 4



inkl. 20 weiße Beschriftungskarten ca. 10 x 8 cm, mehrfach beschriftbar

incl. 20 white labels 10 x 8 cm

incluye 20 etiquetas blancas 10 x 8 cm

20 étiquettes blanches incluses 10 x 8 cm

	cm	pcs.	€
00078	3 x 3 x 3	4	10,00

**Kartenhalter „ZYLINDER“, 4er Set**

table stands, 4 pcs. set
soporte de mesa, set de 4
porte-étiquettes, set de 4



inkl. 20 weiße Beschriftungskarten ca. 10 x 8 cm, mehrfach beschriftbar

incl. 20 white labels 10 x 8 cm

incluye 20 etiquetas blancas 10 x 8 cm

20 étiquettes blanches incluses 10 x 8 cm

	cm	pcs.	€
00079	3 x 3 x 3	4	10,00

**Tafelhalter / Schild**

slate sign
caballete de mesa, pizarra
plaque signalétique avec support



	cm	↑ cm	€
00060	12 x 4	7	7,00

**Kartenhalter, 2er Set**

table stands, 2 pcs. set
portatarjetas, set de 2
porte-cartes, set de 2

BETON
CONCRETE

inkl. 30 Beschriftungskarten ca. 10 x 8 cm (15 x weiß + 15 x schwarz)

incl. 30 labels 10 x 8 cm (15 x white + 15 x black)

incl. 30 tarjetas 10 x 8 cm (15 x blanco + 15 x negro)

incl. 20 étiquettes 10 x 8 cm (15 x blanc + 15 x noir)

	cm	↑ cm	pcs.	€
71495	8 x 3,5	6	2	7,40

**Kartenhalter, 2er Set „KLAMMER“**

table stand, 2 pcs. set
soporte de mesa, set de 2
support de table, set de 2

HOLZ
WOOD

inkl. 30 Beschriftungskarten ca. 10 x 8 cm (15 x weiß, 15 x schwarz)

incl. 30 cards 10 x 8 cm (15 x white, 15 x black)

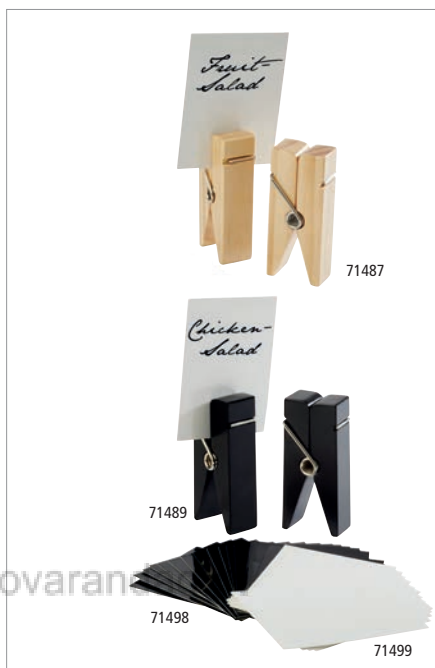
incluye 30 tarjetas 10 x 8 cm (15 x blanco, 15 x negro)

includ 30 étiquettes 10 x 8 cm (15 x blanc, 15 x noir)

	cm	↑ cm	pcs.	Farbe / Colour	€
71487	4 x 2,5	10	2		12,00
71489	4 x 2,5	10	2		12,00

Beschriftungskarten, 50 Stück / designation cards, 50 pcs. set

cartelitos de designación, 50 piezas / cartes de désignation, 50 pièces

	cm	pcs.	Farbe / Colour	fits to	€
71498	10 x 8	50		71487, 71489	4,00
71499	10 x 8	50		71487, 71489	4,00

**Tischkartenhalter „PROFI“**

table stand
soporte de mesa
support de table

METALL
VERCHROMT

	cm	↑ cm	€
40425	9,5 x 7,5	13,5	7,70

**Tischkartenhalter**

table stand
soporte de mesa
support de table

EDELSTAHL
STAINLESS
INOX

möbelschonende Unterseite

non-scratching undersurface

con base antirrayaduras

avec base revêtue antirayures

	cm	↑ cm	€
00071	14 x 5,5	14	15,80

**Schilderhalter „FLEXIBEL“**

sign holder
soporte para cartelito
support pour menu de table



biegsamer Draht mit zwei Klemmen, extrem flexibel, die Klemmen lassen sich weit öffnen
bedable metal coil adds visual interest, two metal clip open
metal cromado flexible, 2 pinzas con gran apertura
métal chromé, flexible, 2 pinces à grande ouverture

	→ cm		€
71470	12	ohne Schilder / without signs sin cartelitos / sans étiquette	3,50
71471	23	ohne Schilder / without signs sin cartelitos / sans étiquette	4,20
71480	12	inkl. 10 Schilder 11879 / incl. 10 signs 11879 con 10 cartelitos 11879 / avec 10 étiquettes 11879	8,40

Schilder, 10er Set / signs, 10 pcs. set / set de 10 cartelitos / set de 10 étiquettes

	cm	€
11879	7,7 x 5,2	4,90
12879	5,0 x 3,0	4,60

**10 Beschriftungsclips, inkl. 10 Schilder**

10 sign holders, with 10 signs
10 soportes + 10 cartelitos
10 supports + 10 étiquettes



	cm	Farbe / Colour	€
71482	6 x 2,7	White	10,50
71483	6 x 2,7	Black	10,50

Schilder, 10er Set / signs, 10 pcs. set / set de 10 cartelitos / set de 10 étiquettes

	cm	€
11879	7,7 x 5,2	4,90
12879	5,0 x 3,0	4,60

**10 Schilderhalter „FLEX CLIP“**

10 sign holders
10 clips
10 porte-étiquettes



Durch die bewegliche Verbindung der Klemme und Schilderhalterung ein extrem flexibler Cliphalter!
multi angle ticket clip / inclinable con pinza / inclinable avec pince

	→ cm	Farbe / Colour	€
71472	9,5	White	12,00
71474	9,5	Black	12,00

Schilder, 10er Set / signs, 10 pcs. set / set de 10 cartelitos / set de 10 étiquettes

	cm	pcs.	€
11879	7,7 x 5,2	10	4,90
12879	5,0 x 3,0	10	4,60

**Tischaufsteller 2er Set**

table stands, 2 pcs. set
caballetes de mesa, set de 2
chevalets de table, set de 2



	cm	↑ cm		€
00017	5,5 x 5	3,5	reserviert	3,80
00013	5,5 x 5	3,5	reserved	3,80
00572	5,5 x 5	3,5	smoking	6,00

**Kartenhalter, 4er Set**

table stands, 4 pcs. set
portatarjetas, set de 4
porte-cartes, set de 4



inkl. 30 Beschriftungskarten ca. 10 x 8 cm (15x weiß, 15x schwarz)
incl. 30 lables 10 x 8 cm (15x white + 15x black)
incl. 30 tarjetas 10 x 8 cm (15x blanco + 15x negro)
incl. 30 étiquettes 10 x 8 cm (15x blanc + 15x noir)

	Ø cm	↑ cm	Farbe / Colour	pcs.	€/Set
71425	3	10	Marmor weiß / marble white	4	19,00
71427	3	10	Marmor grau / marble grey	4	19,00

**Kartenhalter, 4er Set**

table stands, 4 pcs. set
portatarjetas, set de 4
porte-cartes, set de 4



inkl. 30 Beschriftungskarten ca. 10 x 8 cm (15x weiß, 15x schwarz)
incl. 30 lables 10 x 8 cm (15x white + 15x black)
incl. 30 tarjetas 10 x 8 cm (15x blanco + 15x negro)
incl. 30 étiquettes 10 x 8 cm (15x blanc + 15x noir)

	cm	↑ cm	Farbe / Colour	pcs.	€/Set
71426	3,5 x 3,5	10	Marmor weiß / marble white	4	19,00
71428	3,5 x 3,5	10	Marmor grau / marble grey	4	19,00

**Beschriftungsetiketten**

labeling labels
etiquetas
étiquettes



12 Bögen mit je 6 Motiven, selbstklebend, mit wasserlöslichem Stift beschreibbar
12 sheets includes 6 self-adhesive and removable labels, use regular chalkboard markers and wipe clean with a clamp cloth
12 hojas, cada una con 6 motivos autoadhesivos, se pueden marcar con un rotulador lavable con agua
12 feuilles chacune avec 6 motifs autoadhésifs, on peut écrire avec un stylo lavable à l'eau

	cm	Farbe / Colour	€
00069	8,0 x 4,6	■	10,00

**Kreide-Marker, Stärke 2 mm, 2er Set**

chalk marker, 2 pcs. set
rotulador de tiza, set de 2
marqueur a la craie liquide, set de 2



Zum Gestalten und Beschriften von Tafeln, Glas und fast allen geschlossenen Oberflächen, deckende Flüssigkreide auf Wasserbasis, feucht abwischbar

For decorating and writing on boards, glass and almost all non-porous surfaces, opaque water-based liquid chalk, wet-wipeable

Rotuladores para pizarra de tiza líquida para decorar y escribir sobre pizarras, cristales y casi todas las superficies no porosas. Tizi líquida opaca al agua que se pueda borrar con un trapo

Pour décorations et inscriptions sur tableaux, verre et presque toutes les surfaces non poreuses, craie liquide opaque à base d'eau, effaçable avec un chiffon humide

	Ø cm	↑ cm	Farbe / Colour	pcs.	€/Set
71490	1	13	■	2	5,80
71491	1	13	■	2	5,80

**Rechnungstablett**

bill presenter
porta cuenta
porte-addition



mit Klemme für Rechnung
with clip for bill
con clip para la nota
avec clip pour la note

	cm	↑ cm	€
30108	20 x 12	0,5	1,70

**Rechnungstablett**

bill presenter
porta cuenta
porte-addition



mit Klemme für Rechnung
with clip for bill
con clip para la nota
avec clip pour la note

	cm	↑ cm	€
30110	17 x 11	1	5,80

**Rechnungstablett, 2er Set**

bill presenter, 2 pcs. set
porta cuenta, set de 2
porte-addition, set de 2



1 Edelstahl-Tablett hochglanzpoliert + 1 klappbare Ledermappe
mit Stiftflasche, mit Magnethalterung

1 stainless tray mirror polished finish + 1 leather presenter, with magnetic system

1 bandeja de acero inoxidable pulido brillante + 1 presentador de cuero con sistema magnético

1 plateau inox poli brillant + 1 pochette cuir aimantée

	cm	↑ cm	€
30109	20 x 16	2	24,40

**Tischkrümelentferner**

crumber
recogemigas
ramasse-miettes



matt poliert

satin polished finish

acabado mate, fácil de usar, mango hueco

mat satiné, manche creux, simple à utiliser

	Ø cm	↑ cm	€
00058	6,5 x 2,5	22	14,80
00581	19,5 x 4,5	1	7,20

Hohlgriff / hollow handles

geschliffene Edelstahlkante

flat grinded stainless steel edge

**Pfeffermühle „COPPER“**

pepper mill
molinillo de pimienta
moulin à poivre



Mahlwerk aus Carbonstahl, Mahlgrad stufenlos einstellbar

mill in carbon steel, the grinding degree can be adjusted infinitely

molinillo de acero al carbono, el grado de molino se puede ajustar de modo continuo

moulin en acier de carbone, la finesse de mouture se peut régler de façon continue

	∅ cm	↑ cm	€
40551	6	15	14,90

**Salzmühle „COPPER“**

salt mill
molinillo de sal
moulin à sel



Mahlwerk aus Edelstahl, Mahlgrad stufenlos einstellbar

mill in stainless steel, the grinding degree can be adjusted infinitely

molinillo de acero inoxidable, el grado de molino se puede ajustar de modo continuo

moulin en acier inox, la finesse de mouture se peut régler de façon continue

	∅ cm	↑ cm	€
40552	6	15	14,90

**Pfeffermühle „FRIDA“**

pepper mill
molinillo de pimienta
moulin à poivre



Mahlwerk aus Carbonstahl, Mahlgrad stufenlos einstellbar

mill in carbon steel, the grinding degree can be adjusted infinitely

molinillo de acero al carbono, el grado de molino se puede ajustar de modo continuo

moulin en acier de carbone, la finesse de mouture se peut régler de façon continue

	∅ cm	↑ cm	€
40549	6	15,5	16,00

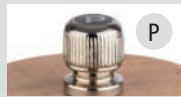
**Salzmühle „FRIDA“**

salt mill
molinillo de sal
moulin à sel



Mahlwerk aus Edelstahl, Mahlgrad stufenlos einstellbar

mill in stainless steel, the grinding degree can be adjusted infinitely

molinillo de acero inoxidable, el grado de molino se puede ajustar de modo continuo

moulin en acier inox, la finesse de mouture se peut régler de façon continue

	∅ cm	↑ cm	€
40550	6	15,5	16,00



**Pfeffermühle „DIAMOND“**

pepper mill
molinillo de pimienta
moulin à poivre



Mahlwerk aus Carbonstahl, Mahlgrad stufenlos einstellbar

mill in carbon steel, the grinding degree can be adjusted infinitely
molinillo de acero al carbono, el grado de molino se puede ajustar de modo continuo
moulin en acier de carbone, la finesse de mouture se peut réglée de façon continue

	Ø cm	↑ cm	€
40553	6	18	16,00

**Salzmühle „DIAMOND“**

salt mill
molinillo de sal
moulin à sel



Mahlwerk aus Edelstahl, Mahlgrad stufenlos einstellbar

mill in stainless steel, the grinding degree can be adjusted infinitely
molinillo de acero inoxidable, el grado de molino se puede ajustar de modo continuo
moulin en acier inox, la finesse de mouture se peut réglée de façon continue

	Ø cm	↑ cm	€
40554	6	18	16,00

**Pfeffermühle „GUNMETAL“**

pepper mill
molinillo de pimienta
moulin à poivre



Mahlwerk aus Carbonstahl, Mahlgrad stufenlos einstellbar

mill in carbon steel, the grinding degree can be adjusted infinitely
molinillo de acero al carbono, el grado de molino se puede ajustar de modo continuo
moulin en acier de carbone, la finesse de mouture se peut réglée de façon continue

	Ø cm	↑ cm	€
40555	6	15,5	29,90

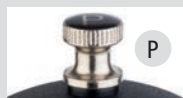
**Salzmühle „GUNMETAL“**

salt mill
molinillo de sal
moulin à sel



Mahlwerk aus Edelstahl, Mahlgrad stufenlos einstellbar

mill in stainless steel, the grinding degree can be adjusted infinitely
molinillo de acero inoxidable, el grado de molino se puede ajustar de modo continuo
moulin en acier inox, la finesse de mouture se peut réglée de façon continue

	Ø cm	↑ cm	€
40556	6	15,5	29,90



**Pfeffermühle „ELEMENT“**

pepper mill
molinillo de pimienta
moulin à poivre



Mahlwerk aus Carbonstahl, Mahlgrad stufenlos einstellbar

mill in carbon steel, the grinding degree can be adjusted infinitely

molinillo de acero al carbono, el grado de molino se puede ajustar de modo continuo

moulin en acier de carbone, la finesse de mouture se peut régler de façon continue

	Ø cm	↑ cm	€
40557	7,5	15,5	21,00

**Salzmühle „ELEMENT“**

salt mill
molinillo de sal
moulin à sel



Mahlwerk aus Edelstahl, Mahlgrad stufenlos einstellbar

mill in stainless steel, the grinding degree can be adjusted infinitely

molinillo de acero inoxidable, el grado de molino se puede ajustar de modo continuo

moulin en acier inox, la finesse de mouture se peut régler de façon continue

	Ø cm	↑ cm	€
40558	7,5	15,5	21,00

**Pfeffermühle „ELEMENT“**

pepper mill
molinillo de pimienta
moulin à poivre



Mahlwerk aus Carbonstahl, Mahlgrad stufenlos einstellbar

mill in carbon steel, the grinding degree can be adjusted infinitely

molinillo de acero al carbono, el grado de molino se puede ajustar de modo continuo

moulin en acier de carbone, la finesse de mouture se peut régler de façon continue

	Ø cm	↑ cm	€
40538	6	18	24,00

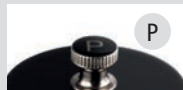
**Salzmühle „ELEMENT“**

salt mill
molinillo de sal
moulin à sel



Mahlwerk aus Edelstahl, Mahlgrad stufenlos einstellbar

mill in stainless steel, the grinding degree can be adjusted infinitely

molinillo de acero inoxidable, el grado de molino se puede ajustar de modo continuo

moulin en acier inox, la finesse de mouture se peut régler de façon continue

	Ø cm	↑ cm	€
40539	6	18	24,00





Pfeffer- u. Salzmühle „PROFESSIONAL“

salt / pepper mill
molinillo de sal / pimienta
moulin à sel / poivre



Mahlgrad stufenlos einstellbar

the grinding degree can be adjusted infinitely
el grado de molino se puede ajustar de modo continuo
la finesse de mouture se peut réglée de façon continue

	Ø cm	↑ cm	Farbe / Colour		€
40540	5,5	15		pepper mill	18,00
40541	5,5	15		salt mill	18,00



Pfeffermühle „PROFESSIONAL VINTAGE“

pepper mill
molinillo de pimienta
moulin à poivre



Deutsches Buchenholz, vintage, Mahlwerk aus Carbonstahl, Mahlgrad stufenlos einstellbar

German beechwood, vintage, mill in carbon steel, the grinding degree can be adjusted infinitely
madera de haya alemana, carácter „vintage“, molinillo de acero al carbono, el grado de molino se puede ajustar de modo continuo
bois de hêtre d'Allemagne, vintage, moulin en acier de carbone, la finesse de mouture se peut réglée de façon continue

	Ø cm	↑ cm	Farbe / Colour		€
40535	5,5	15			22,00
40537	6,0	23			26,00
40546	5,5	15			22,00
40548	6,0	23			26,00



Pfeffermühle

pepper mill
molinillo de pimienta
moulin à poivre



Mahlwerk aus Carbonstahl, Mahlgrad stufenlos einstellbar

mill in carbon steel, the grinding degree can be adjusted infinitely
molinillo de acero al carbono, el grado de molino se puede ajustar de modo continuo
moulin en acier de carbone, la finesse de mouture se peut réglée de façon continue

	Ø cm	↑ cm	Farbe / Colour		€
40559	5,5	18			29,90



Salzmühle

salt mill
molinillo de sal
moulin à sel



Mahlwerk aus Edelstahl, Mahlgrad stufenlos einstellbar

mill in stainless steel, the grinding degree can be adjusted infinitely
molinillo de acero inoxidable, el grado de molino se puede ajustar de modo continuo
moulin en acier inox, la finesse de mouture se peut réglée de façon continue

	Ø cm	↑ cm	Farbe / Colour		€
40560	5,5	18			29,90



Salzmühle „PROFESSIONAL VINTAGE“

salt mill
molinillo de sal
moulin à sel



Deutsches Buchenholz, vintage, Mahlwerk aus Edelstahl, Mahlgrad stufenlos einstellbar

German beechwood, vintage, mill in stainless steel,
the grinding degree can be adjusted infinitely

madera de haya alemana, carácter „vintage“, molinillo de acero
inoxidable, el grado de molino se puede ajustar de modo continuo

bois de hêtre d'Allemagne, vintage, moulin en acier inox, la finesse
de mouture se peut régler de façon continue

	Ø cm	↑ cm	Farbe / Colour	€
40536	5,5	15		22,00
40547	5,5	15		22,00



Pfeffermühle „PROFESSIONAL“

pepper mill
molinillo de pimienta
moulin à poivre



Mahlwerk aus Carbonstahl, Mahlgrad stufenlos einstellbar

mill in carbon steel, the grinding degree can be adjusted infinitely

molinillo de acero al carbono, el grado de molino se puede ajustar de modo continuo

moulin en acier de carbone, la finesse de mouture se peut régler de façon continue

	Ø cm	↑ cm	Farbe / Colour	€
40530	5,5	15		20,90
40532	7,0	30		31,00
40534	7,0	40		52,00



Mahlgrad einstellbar
grinder setting

	Ø cm	↑ cm	Farbe / Colour	€
40520	5,5	15		20,90
40522	7,0	30		31,00
40524	7,0	40		52,00



Mahlgrad einstellbar
grinder setting



Salzmühle „PROFESSIONAL“

salt mill
molinillo de sal
moulin à sel



Mahlwerk aus Edelstahl, Mahlgrad stufenlos einstellbar

mill in stainless steel, the grinding degree can be adjusted infinitely

molinillo de acero inoxidable, el grado de molino se puede ajustar de modo continuo

moulin en acier inox, la finesse de mouture se peut régler de façon continue

	Ø cm	↑ cm	Farbe / Colour	€
40531	5,5	15		20,90
40521	5,5	15		20,90



Tablett

tray
bandeja
plateau

mit 2 Absätzen Ø 6 cm
with 2 holes Ø 6 cm
con 2 agujeros Ø 6 cm
avec 2 trous Ø 6 cm



	cm	↑ cm	€
84039	16,5 x 8,5	1,5	3,50



Naturschieferplatte / Untersetzer

natural slate tray
bandeja de pizarra natural
plateau ardoise naturelle

mit 2 Absätzen Ø 6 cm
with 2 holes Ø 6 cm
con 2 agujeros Ø 6 cm
avec 2 trous Ø 6 cm



	cm	✱ mm	€
00971	15 x 8	6 - 9	3,00



2 in 1 Salz- u. Pfeffermühle

2 in 1 salt / pepper mill
2 in 1 molinillo de sal / pimienta
2 in 1 moulin à sel / poivre

Keramik Mahlwerk
ceramic mechanism
molinillo de cerámica
broyeur en céramique



	Ø cm	↑ cm	€
40545	7,5	18,5	20,00



Mahlgrad einstellbar
grinder setting

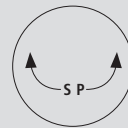

2 in 1 Salz- u. Pfeffermühle

2 in 1 salt / pepper mill
2 in 1 molinillo de sal / pimienta
2 in 1 moulin à poivre / sel

Keramik Mahlwerk
ceramic mechanism
molinillo de cerámica
broyeur en céramique



	cm	↑ cm	€
40544	6 x 4,5	9,5	18,00



Mahlgrad einstellbar
grinder setting

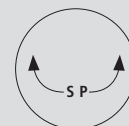

**Käse- oder Gewürzstreuer**

spice shaker
botes especieros
saupoudreuse à épices

Löcher Ø 5 mm, inkl. Staubdeckel

holes Ø 5 mm, incl. cover

agujeros Ø 5 mm, tapa plástico

trous Ø 5 mm, couvercle plastique



	Ø cm	↑ cm	ltr.	€
00775	5,5	7,5	0,15	5,40

**Netzstreuer**

mesh top shaker
polvoreador, tapa con malla fina
pot à épices, couvercle toile fine

inkl. Staubdeckel

incl. cover

tapa plástico

couvercle plastique



	Ø cm	↑ cm	ltr.	€
00776	5,5	7,5	0,15	5,40

**Streuer fein**

small hole shaker
polvoreador, tapa con agujeros pequeños
pot à épices, couvercle à petits trous

Löcher Ø 1 mm, inkl. Staubdeckel

holes Ø 1 mm, incl. cover

agujeros Ø 1 mm + tapa plástico

trous Ø 1 mm + couvercle plastique



	Ø cm	↑ cm	ltr.	€
00777	5,5	7,5	0,15	4,90

**Streuer grob**

large hole shaker
polvoreador, tapa con agujeros grandes
pot à épices, couvercle à grands trous

Löcher Ø 2,5 mm, inkl. Staubdeckel

holes Ø 2,5 mm, incl. cover

agujeros Ø 2,5 mm + tapa plástico

trous Ø 2,5 mm + couvercle plastique



	Ø cm	↑ cm	ltr.	€
00778	5,5	7,5	0,15	4,90



Multistreuer
multi-functional shaker
salero
saupoudreuse



	Ø cm	↑ cm	ltr.	€
00774	7	12	0,20	12,00



geschlossen



Ø 2 mm



Ø 4 mm



Ø 6 mm



Multistreuer
multi-functional shaker
salero
saupoudreuse



	Ø cm	↑ cm	ltr.	€
00773	6	8	0,05	8,00



geschlossen



Ø 2 mm



Ø 4 mm



Ø 6 mm



Netzstreuer
mesh top shaker
polvoreador, tapa con malla fina
pot à épices, couvercle toile fine



	Ø cm	↑ cm	ltr.	€
00781	6,5	12	0,20	11,00



Multistreuer / Gewürzstreuer
multi-functional shaker
juego dosificador
jeu de salières



	Ø cm	↑ cm	ltr.	€
00782	6,5	12	0,20	10,00

00783	6,5	12	0,20	mit 8 Löchern / with 8 holes con 8 agujeros / avec 8 trous	10,00
-------	-----	----	------	---	-------



00782 - Ø 2 mm



00783 - Ø 8 mm

**Salz- und Pfefferstreuer, 2er Set**

salt - and pepper shaker, 2 pcs. set
piezas de sal y pimienta, set de 2
sel et poivre, set de 2



	Ø cm	↑ cm	pcs.		€
40500	5	6,5	2	glatte Ausführung / smooth version versión recta / forme lisse	2,40
40501	5	6,5	2	geriffelte Ausführung / fluted version versión ondulada / forme ondulée	2,40
40507	6	10,0	2		8,60

**Allzweckstreuer, 12er Set**

shaker, 12 pcs. set
dosificador, set de 12
salières/poivrières, set de 12



	cm	↑ cm	pcs.		€
40504	4 x 4	10	12	13 Löcher / 13 holes 13 agujeros / 13 trous	20,00
40505	4 x 4	10	12	3 Löcher / 3 holes 3 agujeros / 3 trous	16,00

**Ministreuer, 4er Set**

smaller shaker, 4 pcs. set
bodegas pequeñas, set de 4
mini-salières, set de 4



	Ø cm	↑ cm	pcs.		€
40503	3,5	4	4		4,00

**Salzstreuer**

salt shaker
salero
salière

**Pommes-Frites Streuer mit Schraubkappe**

for french fries, cover to screw
para patatas fritas, tapa de rosca
pour les frites, couvercle à visser

	Ø cm	↑ cm		€
00779	8	17	Aluminium / aluminium aluminio / aluminium	8,90
00772	8	17	Edelstahl / stainless steel acero inoxidable / inox	11,40

**Pfeffer- & Salz-Menage „WOOD“**

salt- and pepper-menage
salero-pimentero
ménage sel et poivre



matt poliert, Glasbehälter mit Edelstahl-Deckel und Deckelverschluss
satin polished finish, glass with stainless steel cover
pulido acabado efecto satinado, cristal con tapa de acero inoxidable
verre et inox mat satiné

	cm	↑ cm	€
40435	11,5 x 5,5	17	16,00

**Essig- & Öl-Menage „WOOD“**

oil- and vinegar-menage
aceitera-vinagrera
ménage huile et vinaigre



matt poliert, Glasbehälter mit Edelstahl-Deckel und Deckelverschluss
satin polished finish, glass with stainless steel cover
pulido acabado efecto satinado, cristal con tapa de acero inoxidable
verre et inox mat satiné

	cm	↑ cm	€
40436	16 x 7,5	24,5	24,00

**Pfeffer-, Salz-, Essig- und Öl-Menage „WOOD“**

salt- and pepper- and oil- and vinegar-menage
salero-pimentero & aceitera-vinagrera
ménage sel et poivre & huile et vinaigre



matt poliert, möbelschonende Unterseite
satin polished finish, glass with stainless steel cover
pulido acabado efecto satinado, con tapa de acero inoxidable
verre et inox mat satiné, avec couvercle inox

	cm	↑ cm	€
40437	15,5 x 12	24,5	32,00

Salz- und Pfefferstreuer / salt - and pepper shaker / juego de sal y pimienta / set sel et poivre

	Ø cm	↑ cm		€
40438	4	9	6 Löcher - Ø 1,85 mm	3,80
40439	4	9	18 Löcher - Ø 1,35 mm	3,80

Ersatzglas Essig / Öl / spare glass vinegar / oil / cristal de recambio con tapa „aceite & vinagre“

	Ø cm	↑ cm	litr.	€
40442	6	18,5	0,2	6,00



praktischer Ausgießer
no drips pourer



Pfeffer- und Salz-Menage „ELEMENT“

salt- and pepper-menage
salero-pimentero
ménage sel et poivre



Beton-Ständer, Glasbehälter mit Edelstahl-Deckel, möbelschonende Unterseite

stand made of concrete, glass with stainless steel cover, furniture-friendly underside

soporte de hormigón, recipiente de vidrio con tapa de acero inoxidable, con base anti rayaduras
support en béton, récipient en verre avec couvercle en acier inox, avec revêtement antirayures

	cm	↑ cm	€
40410	10 x 6	17	16,00



Essig- und Öl-Menage „ELEMENT“

oil- and vinegar-menage
aceitera-vinagrera
ménage huile et vinaigre



Beton-Ständer, Glasbehälter mit Edelstahl-Deckel und tropffreiem Kunststoff-Ausgießer, möbelschonende Unterseite

stand made of concrete, glass with stainless steel cover and non-drip nozzle-spout, furniture-friendly underside

soporte de hormigón, recipiente de vidrio con tapa de acero inoxidable y sistema antigoteo, con base anti rayaduras
support en béton, récipient en verre avec couvercle en acier inox et verseur antigoutte, avec revêtement antirayures

	cm	↑ cm	€
40411	14 x 8	25	24,00



Pfeffer-, Salz-, Essig- und Öl-Menage „ELEMENT“

salt- and pepper- and oil- and vinegar-menage
salero-pimentero & aceitera-vinagrera
ménage sel et poivre & huile et vinaigre



Beton-Ständer, Glasbehälter mit Edelstahl-Deckel und Drehverschluss, möbelschonende Unterseite

stand made of concrete, glass with stainless steel cover and screw cap, furniture-friendly underside

soporte de hormigón, recipiente de vidrio con tapa de acero inoxidable y tapón de rosca, con base anti rayaduras
support en béton, récipient en verre avec couvercle en acier inox et bouchon à vis, avec revêtement antirayures

	cm	↑ cm	€
40412	12,5 x 12,5	25	34,00



Pfeffer-, Salz-, Essig- und Öl-Menage „ELEMENT“

salt- and pepper- and oil- and vinegar-menage
salero-pimentero & aceitera-vinagrera
ménage sel et poivre & huile et vinaigre



Beton-Ständer mit Kartenhalterung, Glasbehälter mit Edelstahl-Deckel und Drehverschluss, möbelschonende Unterseite

stand made of concrete with card holder, glass with stainless steel cover and screw cap, furniture-friendly underside

soporte de hormigón con tarjetero, recipiente de vidrio con tapa de acero inoxidable y tapón de rosca, con base anti rayaduras
support en béton avec porte-cartes, récipient en verre avec couvercle en acier inox et bouchon à vis, avec revêtement antirayures

	cm	↑ cm	€
40413	14 x 13,5	20	34,00



mit Kartenhalterung an der Rückseite
with card holder at the back

**Pfeffer- & Salz-Menage „CLASSIC“**

salt- and pepper-menage
salero-pimentero
ménage sel et poivre

**Glasbehälter mit Edelstahl-Deckel und Drehverschluss**

glass with stainless steel cover
vidrio con tapa de acero inoxidable con rosca
en verre avec couvercle inox à visser

	cm	↑ cm	€
40310	10,5 x 6,5	16	16,90

**Pfeffer- & Salz-Menage „CLASSIC“**

salt- and pepper-menage
salero-pimentero
ménage sel et poivre

**Glasbehälter mit Edelstahl-Deckel und Drehverschluss**

glass with stainless steel cover
vidrio con tapa de acero inoxidable con rosca
en verre avec couvercle inox à visser

	Ø cm	↑ cm	€
40320	10,5	16	21,00

**Menage „CLASSIC“**

menage
menage
ménage

**Glasbehälter mit Edelstahl-Deckel und tropffreiem Kunststoff-Ausgießer**

with stainless steel cover and non-drip nozzle-spout
vidrio con tapa inox y sistema antigoteo
verre avec couvercle inox et verseur antigoutte

	cm	↑ cm	ltr.	€
40440	14,5 x 8,5	23	0,2	26,00
40450	17,5 x 10,5	23		30,00

Ersatzglas mit Deckel / spare glass with cover / vidrio con tapa / verre + couvercle

	Ø cm	↑ cm	€	
40312	4	9	18 Löcher - Ø 1,35 mm	3,80
40311	4	9	6 Löcher - Ø 1,85 mm	3,80

Ersatzglas mit Deckel „Essig & Öl“ / spare glass with cover „vinegar & oil“ / cristal de recambio con tapa „vinegar & oil“ / verre huile ou vinaige avec couvercle inox et verseur antigoutte

	Ø cm	↑ cm	ltr.	€
40441	6	18,5	0,2	7,00

Ersatzglas mit Deckel „Zahnstocher“ / spare glass with cover „toothpick“ / porta-palillos vidrio con tapa / verre à cure-dents + couvercle

	Ø cm	↑ cm	€
40313	4	9	3,80

**Senftöpfchen, 2er Set**

mustard glass, 2 pcs. set
piezas vasos mostaza, set de 2
verres à moutarde, set de 2

**inkl. Löffel und Edelstahl-Deckel**

incl. spoons and covers
incluye cucharas y tapas
cuillères et couvercles inclus

	Ø cm	↑ cm	pcs.	€
40415	5	6	2	5,00

**Menage „ECONOMIC“**

menage
menage
ménage

**Glasbehälter mit Edelstahl-Deckel und Drehverschluss**

glass with stainless steel cover
cristal con tapa inox a rosca
en verre avec couvercle inox à visser

	cm	↑ cm	€
40455	8 x 4	13	4,20

**Menage „ECONOMIC“**

menage
menage
ménage

**Glasbehälter mit Edelstahl-Deckel und Drehverschluss**

glass with stainless steel cover
cristal con tapa inox a rosca
en verre avec couvercle inox à visser

	cm	↑ cm	€
40457	8 x 8	12	6,40

Glas für Senf / glass for mustard / vaso de cristal para mostaza / pot verre seul pour la moutarde

	cm	↑ cm	€
40464			1,80

**Menage „ECONOMIC“**

menage
menage
ménage

**Glasbehälter mit Edelstahl-Deckel und tropffreiem Kunststoff-Ausgießer**

glasses with stainless steel cover and non-drip nozzle-spout
cristales con tapa de acero inoxidable y sistema antigoteo
en verre avec couvercle inox et insert plastique antigoutte

	cm	↑ cm	€
40458	11,5 x 5,5	22	8,20
40460	11,0 x 10,5	22	12,40

Pfeffer- oder Salz-Glasstreuer / pepper- or salt-glass with cover salero o pimentero de cristal con tapa / salière ou poivrière seule en verre avec couvercle inox

	Ø cm	↑ cm	€
40461	3	9	2,00

Essig- oder Öl-Glasbehälter / oil- or vinegar-glass with cover / aceitera-vinagrera con tapa bouteille huile ou vinaigre seule en verre et couv. inox

	Ø cm	↑ cm	€
40462	4,5	16	3,20

Glas für Zahnstocher / glass for tooth picks / vaso de cristal para palillos de dientes porte-cure-dents env erre

	Ø cm	↑ cm	€
40463	3	6	1,30



40476



40478



40480

Menage „PRO“

menage
menage
ménage



matt poliert, Glasbehälter mit Edelstahl-Deckel und tropffreiem Kunststoff-Ausgießer

satin polished finish, glass with stainless steel cover and non-drip nozzle-spout

inox satinado, vidrio, sistema antigoteo

inox poli mat satiné et verre, insert plastique antigoutte

	cm	↑ cm	€
40476	12,0 x 8,0	19	10,60
40478	12,5 x 11,0	19	15,00
40480	13,0 x 11,0	19	15,70

Pfeffer- oder Salz-Glasstreuer / pepper- or salt-glass with cover / salero o pimentero de cristal con tapa
 salière ou poivrière seule en verre avec couvercle inox

	Ø cm	↑ cm	€
40461	3	9	2,00

Essig- oder Öl-Glasbehälter / oil- or vinegar-glass with cover / aceitera-vinagrera con tapa
 bouteille huile ou vinaigre seule en verre et couv. inox

	Ø cm	↑ cm	€
40462	4,5	16	3,20



40470



40472



40474

Menage „PRO“

menage
menage
ménage



matt poliert, Glasbehälter mit Edelstahl-Deckel und Drehverschluss

satin polished finish, glass with stainless steel cover

inox satinado, vidrio y tapas con rosca

inox poli mat satiné et verre, couvercle à visser

	cm	↑ cm	€
40470	8,5 x 5,7	11,5	5,40
40472	9,2 x 8,5	11,5	6,80
40474	10,0 x 10,0	11,5	7,60

**Parmesan-Menage „CLASSIC“**

cheese dish
quesera parmesano
service à parmesan

hochglanzpoliert, inkl. Löffel
mirror polished finish, with spoon
pulido efecto espejo, con bol cristal y cuchara
brillant, avec bol verre et cuillère



	∅ cm	↑ cm	€
40330	10,5	7	16,90

Ersatzbehälter / sparecontainer / bol de recambio / bol de rechange

	∅ cm	€
40331	10,5	4,50

**Parmesan-Menage „PROFI“**

cheese dish
quesera parmesano
service à parmesan

hochglanzpoliert, inkl. Löffel
mirror polished finish, with spoon



Ersatzbehälter / sparecontainer / bol de recambio / bol de rechange

	∅ cm	↑ cm	€
40424	9	5,5	13,50

	∅ cm	€
40331	10,5	4,50

**Parmesan-Menage „PRO“**

cheese dish
quesera parmesano
service à parmesan

matt poliert, inkl. Löffel
satin polished finish, with spoon
pulido mate satinado, con bol cristal y cuchara
mat satiné, avec bol verre et cuillère



	∅ cm	↑ cm	€
40482	10,5	13	8,80

Ersatzbehälter / sparecontainer / bol de recambio / bol de rechange

	∅ cm	€
40331	10,5	4,50

**Parmesan-Menage „ECONOMIC“**

cheese dish
quesera parmesano
service à parmesan

inkl. Kunststofflöffel
with spoon
con cuchara
avec cuillère



	∅ cm	↑ cm	€
40453	10,5	7	5,70

Ersatzbehälter / sparecontainer / bol de recambio / bol de rechange

	∅ cm	€
40454	10,5	2,10



Essig- & Öl-Menage

oil- and vinegar-menage
aceitera-vinagrera
ménage huile et vinaigre



Glasbehälter mit Deckel und tropffreiem PE-Ausgießer

glass with lid and non-drip nozzle-spout

recipiente de cristal con tapa y sistema antigoteo

pot en verre avec couvercle et système plastique antigoutte

	cm	↑ cm	ltr.	€
40445	10,5 x 5,5	24	0,12	9,00
40446	13,0 x 7,0	34	0,50	12,00



tropffreier Ausgießer
non-drip spout



250 ml

Ständer

servicing stand

soporte 2 botellas

support 2 bouteilles



matt poliert, passend für handelsübliche 500 ml Flaschen, Lieferung ohne Flaschen

satin polished finish, for standard bottles with 500 ml content, delivery without bottles

inox satinado, para botellas estándar de 500 ml, se entrega sin botellas

inox mat satiné, pour bouteilles standard de 500 ml, livré sans bouteilles

	cm	↑ cm	€
40443	13 x 7	30	19,80



Gewürzständer

condiment stand

soporte salsas y condimentos

porte condiments et sauces

matt poliert, Lieferung ohne Deko

satin polished finish

acabado pulido efecto satinado

poli mat satiné



	Ø cm	↑ cm	€
40300	19	20	19,50



Menage

menage

menage

ménage



drehbares Gestell, Glasbehälter mit Edelstahl-Deckel und Drehverschluss

rotating stand, glass with stainless steel cover

soporte giratorio con piezas de vidrio y tapas inox

tournant, avec pièces en verre et couvercle inox

	Ø cm	↑ cm	€
40485	16	20	18,00

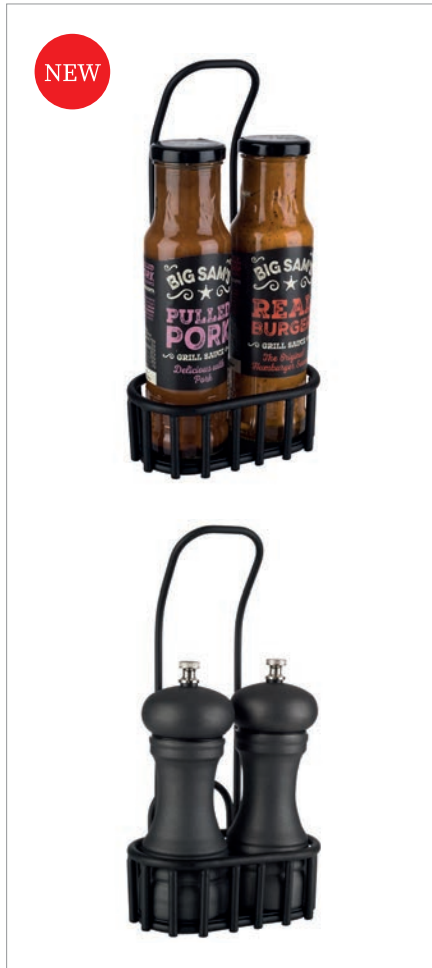

NEW

Ständer „URBAN“

serving stand
soporte 2 botellas
support 2 bouteilles

Metall schwarz, mit Kartenhalterung
metal black, with card holder
metal negro, con tarjetero
métal noir, avec porte-cartes



	cm	↑ cm	€
40414	13 x 8,5	25	7,00



mit Kartenhalterung an der Rückseite
with card holder at the back



NEW

350 ml

Essig- & Öl-Flasche „OLD FASHIONED“

oil- and vinegar bottle
botella de aceite y vinagre
bouteille d'huile et vinaigre

Glasflasche, Edelstahl - Ausgießer mit Deckel
glass bottle, stainless steel spout with lid
botella de vidrio, pico verteder de acero inoxidable con tapa
bouteille en verre, bec verseur en acier inox avec couvercle



	Ø cm	↑ cm	ltr.	€
40511	7	22	0,35	4,90



93308

200 ml

93309

Spritzflasche inklusive Ausgießer

squeeze bottle with nozzle
botella exprimible con dosificador
flacon pulvérisateur avec bec verseur

ideal für Bitter-Liköre, Essig, Öl
perfect for bitter liqueur, vinegar, oil
perfecto para licores amargos, vinagre, aceite
idéal pour liqueur amère, vinaigre, huile



	cm	↑ cm	ltr.	€
93308	6 x 5	20	0,2	9,00

Ausgießer passend für Spritzflasche / nozzle suitable for squeeze bottle / dosificador apto para botella exprimible / bec verseur approprié pour flacon pulvérisateur

	Ø cm	↑ cm	€
93309	2,5	5,5	2,60

NEW



350 ml

Zuckerdosierer „OLD FASHIONED“sugar dispenser
azucarero
sucrier

Schraubdeckel aus Edelstahl, mit Dosierklappe
cover stainless steel with dosing flap
tapa de acero inoxidable, con cierre dosificador
couvercle en acier inox, avec couvercle de dosage

	Ø cm	↑ cm	ltr.	€
40510	7,5	14	0,35	3,60

mit Dosierklappe
with dosing flap

300 ml

Zuckerdosierersugar dispenser
azucarero
sucrier

Schraubdeckel aus Edelstahl
cover stainless steel
tapa de acero inoxidable
couvercle en acier inox

	Ø cm	↑ cm	ltr.	€
00766	8,5	15	0,3	3,50

Ersatzglasbehälter / spare glas-container / contenedor de repuesto / récipient verre de rechange

	fits to	€
00768		1,80

40490
150 ml**Zuckerdosierer**sugar dispenser
azucarero
sucrier

Schraubdeckel aus Edelstahl, mit Dosierrohr
cover stainless steel with dosing tube
tapa de acero inoxidable y tubo dosificador
couvercle en acier inox et tube doseur

	Ø cm	↑ cm	ltr.	€
40490	8,5	12	0,15	2,90
40494	8,5	15	0,25	2,90

Ersatzglasbehälter / spare glas-container / contenedor de repuesto / récipient verre de rechange

	fits to	€
40498	40490	1,60
40499	40494	1,60

40494
250 ml

**Zuckerdosierer**

sugar dispenser
azucarero
sucrier



Schraubdeckel aus Edelstahl mattiert, mit Dosierrohr
cover stainless steel matt polished, with dosing tube
tapa de rosca de acero inoxidable mate y tubo dosificador
couvrerle à vis en acier inox mat et tube doseur

	Ø cm	↑ cm	ltr.	€
40509	6	14,5	0,20	10,40

**Zuckerdosierer**

sugar dispenser
azucarero
sucrier



Schraubdeckel aus Edelstahl, mit Dosierrohr
cover stainless steel, with dosing tube
tapa de acero inoxidable y tubo dosificador
couvrerle en acier inox et tube doseur

	Ø cm	↑ cm	ltr.	€
40486	8,0	15	0,25	2,90
40506	7,5	17	0,32	4,20

**Allzweckgießer**

pourer
dosificador
doseur



Schraubdeckel aus Edelstahl und Kunststoff, mit Dosierklappe
cover stainless steel and plastic, with dosing flap
tapa de acero inoxidable y plástico, con cierre dosificador
couvrerle en acier inox et plastique, avec couvercle de dosage

	Ø cm	↑ cm	ltr.	€
40488	8	12,5	0,25	5,60

**Allzweckgießer**

pourer
bote vertedor universal
pot verseur universel



für Honig, Kaffeesahne, etc., Schraubdeckel aus Edelstahl
for honey, cream, etc., cover stainless steel
para miel, crema, etc., tapa de acero inoxidable
pour le miel, le lait, la crème, etc., couvercle en acier inox

	Ø cm	↑ cm	ltr.	€
00765	8,5	13,5	0,3	6,60

Ersatzglasbehälter / spare glas-container / contenedor de repuesto / récipient verre de rechange

	Ø cm	↑ cm	ltr.	€
00768				1,80



320 ml

Zuckerdosierersugar dispenser
azucarero
sucrier**Schraubdeckel mit Klappe aus Edelstahl, mit Dosierklappe**cover stainless steel, with dosing flap
tapa acero inoxidable, con cierre dosificador
couvercle inox, avec couvercle doseur

	Ø cm	↑ cm	ltr.	€
40487	7,5	13,5	0,32	3,60



200 ml

Zuckerdosierersugar dispenser
azucarero
sucrier**mit Schraubverschluss, Dosier-Rohr Ø 15 mm**cover and dosingtube Ø 15 mm
con tapa y tubo dosificador Ø 15 mm
couvercle avec tube doseur Ø 15 mm

	Ø cm	↑ cm	ltr.	€
40508	6,5	14,5	0,20	9,90



170 ml

Zuckerspender / Milchkännchensugar pourer / milk jug
dispensador de azúcar
sucrier doseur**matt poliert**satin polished finish
pulido efecto satinado
intérieur et extérieur poli mat

	Ø cm	↑ cm	ltr.	€
10316	5	15	0,17	8,60

**Zuckerkuigel**sugar pot
azucarero
sucrier**hochglanzpoliert, mit Rolldecke**mirror polished finish, rolltop cover
pulido acabado brillante, tapa abatible
brillant, couvercle abattant

	Ø cm	↑ cm	€
00033	13,5	15	10,90

**Butterservierer**butter dish
mantequillera
beurrier

	Ø cm	↑ cm	€
15925	9	9	7,00

**Butterservierer**butter dish
mantequillera
beurrier

	cm	↑ cm	€
15926	9 x 9	9	7,00

**Butterservierer**butter dish
mantequillera
beurrierhochglanzpoliert
mirror polished finish
acabado brillante
poli brillant

	Ø cm	↑ cm	€
15921	9	7	13,00

**Schale „ENAMELWARE“**bowl
cuenco
bol

	cm	↑ cm	€
40667	16 x 12,0	3,5	7,20
40668	18 x 13,5	4,0	7,60



hot price

Kühlschrank-Butterdoserefrigerator butter dish
mantequillera para nevera
boite à beure pour le frigo

	cm	↑ cm	€
00063	16 x 9,5	5,5	2,50

**Eierbecher**egg holder
huevera
coquetier

	Ø cm	↑ cm	€
00032	8,5	2	1,60

VINTAGE



Table Caddy „VINTAGE“

table caddy
caddy de mesa
caddy de table



unterteilt in 5 Fächer
divided into 5 compartments
dividido en 5 compartimentos
divisé en 5 compartiments

11608 22 x 15,5 11,5 € 19,00

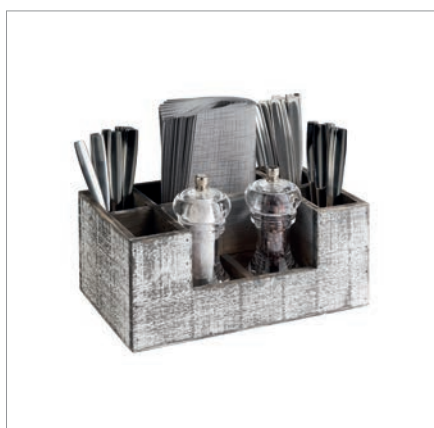

Table Caddy „VINTAGE“

table caddy
caddy de mesa
caddy de table



unterteilt in 7 Fächer
divided into 7 compartments
dividido en 7 compartimentos
divisé en 7 compartiments

11609 25,5 x 15,5 11,5 € 19,00



Table Caddy „VINTAGE“

table caddy
caddy de mesa
caddy de table



unterteilt in 4 Fächer, mit Tragegriff
divided into 4 compartments, with handle
dividido en 4 compartimentos, con asa
divisé en 4 compartiments, avec poignée

11610 22 x 15,5 22 € 19,00



Table Caddy „VINTAGE“

table caddy
caddy de mesa
caddy de table



	cm	↑ cm	€
11612	15 x 15	10	9,00
11613	15 x 15	15	12,00

www.ovarandao.pt

www.ovarandao.pt

	cm	↑ cm	€
11614	30 x 15	15	14,00



GN 1/1 Tablett / GN tray / GN bandeja / GN plateau

	cm	↑ cm	GN	€
11615	53 x 32,5	5	1/1	16,00



Buffettisch „MINI VINTAGE“

buffet stand
soporte para buffet
présentoir buffet



	cm	↑ cm	fits to	€
11634	40 x 21,5	15	GN 1/3 trays	19,00



VINTAGE



11633

11631

11630

11632



11631

11630

Holzbox „VINTAGE“

woodbox
caja madera
base bois



Schubladenoptik, mit Knopf

drawer look, with knob

look cajón, con pomo

look tiroir, avec bouton

	cm	↑ cm	inner size cm	€
11631	18,5 x 18,5	11	17 x 17, mit Beschriftungsfach	13,00
11630	11,5 x 7,5	5	10 x 6	4,00



11633

11632

Holzbox „VINTAGE“

woodbox
caja madera
base bois



Schubladenoptik, mit Knopf

drawer look, with knob

look cajón, con pomo

look tiroir, avec bouton

	cm	↑ cm	inner size cm	€
11633	18,5 x 18,5	11	17 x 17, mit Beschriftungsfach	13,00
11632	11,5 x 7,5	5	10 x 6	4,00



11636

Table Caddy „VINTAGE“table caddy
caddy de mesa
caddy de table

herausnehmbare Aufteilung, 4-Fächer (7 x 7 cm)
separation removable, 4 compartments (7 x 7 cm)
separadores amovibles, 4 compartimentos (7 x 7 cm)
séparateurs amovibles, 4 compartiments (7 x 7 cm)

	cm	↑ cm	Farbe / Colour	€
11635	17 x 17	10		18,00
11636	17 x 17	10		18,00
11637	17 x 17	10		18,00



11602

Table Caddy „VINTAGE“table caddy
caddy de mesa
caddy de table

herausnehmbare Aufteilung, 4-Fächer (7 x 7 cm)
separation removable, 4 compartments (7 x 7 cm)
separadores amovibles, 4 compartimentos (7 x 7 cm)
séparateurs amovibles, 4 compartiments (7 x 7 cm)

	cm	↑ cm	Farbe / Colour	€
11600	17 x 17	16		20,00
11601	17 x 17	16		20,00
11602	17 x 17	16		20,00



11640



11638

Table Caddy „VINTAGE“table caddy
caddy de mesa
caddy de table

herausnehmbare Aufteilung, 6 Fächer (7,5 x 7,5 cm)
separation removable, 6 compartments (7,5 x 7,5 cm)
separadores amovibles, 6 compartimentos (7,5 x 7,5 cm)
séparateurs amovibles, 6 compartiments (7,5 x 7,5 cm)

	cm	↑ cm	Farbe / Colour	€
11638	27 x 17	10		22,00
11639	27 x 17	10		22,00
11640	27 x 17	10		22,00



11603

Table Caddy „VINTAGE“table caddy
caddy de mesa
caddy de table

herausnehmbare Aufteilung, 6 Fächer (7,5 x 7,5 cm)
separation removable, 6 compartments (7,5 x 7,5 cm)
separadores amovibles, 6 compartimentos (7,5 x 7,5 cm)
séparateurs amovibles, 6 compartiments (7,5 x 7,5 cm)

	cm	↑ cm	Farbe / Colour	€
11603	27 x 17	16		24,00
11604	27 x 17	16		24,00
11605	27 x 17	16		24,00

**Table Caddy „ACACIA“**

table caddy
caddy de mesa
caddy de table

**Akazienholz, 3-Fächer**

Fach 1+3: 11,5 x 5,5 cm / Fach 2: 12,0 x 11,5 cm

acacia wood, 3 compartments

compartment 1+3: 11,5 x 5,5 cm / compartment 2: 12,0 x 11,5 cm

madera de acacia, 3 compartimentos

compartimento 1+3: 11,5 x 5,5 cm / compartimento 2: 12,0 x 11,5 cm

bois d'acacia, 3 compartiments

compartiments 1+3: 11,5 x 5,5 cm / compartiment 2: 12,0 x 11,5 cm

	cm	↑ cm	€
40403	27,5 x 13,5	24	29,00

passende Brottasche / suitable bread basket / panera a juego / corbeille assortie

	cm	↑ cm	Farbe / Colour	€
30355	12 x 11,5	11,5		5,40
30356	12 x 11,5	11,5		5,40

Table Caddy

table caddy
caddy de mesa
caddy de table

**Akazienholz, 2-Fächer**

acacia wood, 2 compartements

madera de acacia, 2 compartimentos

bois d'acacia, 2 compartiments

	cm	↑ cm	inner size cm	€
40405	25 x 15	18	21,5 x 8	29,00

Table Caddy „VINTAGE“

table caddy
caddy de mesa
caddy de table

**Holz, 2-Fächer (13,5 x 6 cm)**

2 compartments (13,5 x 6 cm)

2 compartimentos (13,5 x 6 cm)

2 compartiments (13,5 x 6 cm)

	cm	↑ cm	inner size cm	€
40404	15,5 x 15,5	15	13,5 x 6	16,00

Holzbox „WOODY“

woodbox
caja madera
base bois

**Akazienholz, 4-Fächer**

acacia wood, 4 compartements

madera de acacia, 4 compartimentos

bois d'acacia, 4 compartiments

	cm	↑ cm	inner size cm	€
11649	36 x 14	12,5	12,5 x 8	12,00

**Holzbox „TABLE“**

woodbox
caja madera
base bois

**Akazienholz, 3 Fächer (6,5 x 6,5 cm)**

acacia wood, 3 compartments (6,5 x 6,5 cm)
madera de acacia, 3 compartimentos (6,5 x 6,5 cm)
bois d'acacia, 3 compartiments (6,5 x 6,5 cm)

	cm	↑ cm	inner size cm	€
11727	23,5 x 8,5	4,5	6,5 x 6,5 je Fach / each compartment	12,00

**Holzbox „VINTAGE“**

woodbox
caja madera
base bois

**Akazienholz, vintage weiß**

acacia wood, vintage white
madera de acacia, blanca vintage
bois d'acacia, blanc vintage

	cm	↑ cm	inner size cm	€
11725	15,0 x 9,5	5	12 x 6,5	9,00

**Holzbox „TABLE“**

woodbox
caja madera
base bois

**Akazienholz natur**

acacia wood nature
madera de acacia natural
bois d'acacia naturel

	cm	↑ cm	inner size cm	€
11726	15,0 x 9,5	5	12 x 6,5	9,00

**Table Caddy**

table caddy
caddy de mesa
caddy de table

**Akazienholz**

acacia wood
madera de acacia
bois d'acacia

	cm	↑ cm	inner size cm	€
11625	23 x 10	10	22,5 x 6	9,60

**Holzbox „WOODY“**

woodbox
caja madera
base bois

**Akazienholz**

acacia wood
madera de acacia
bois d'acacia

	cm	↑ cm	inner size cm	€
11650	15,0 x 15	5,5	13 x 13	11,00
11651	22,5 x 15	5,5	13,5 x 13 / 6,5 x 13	14,00



Servierbrett „NARROW“

serving board
tabla de servir
planche de service



Akazienholz, mit 3 Vertiefungen Ø 6 cm
acacia wood, with 3 notches Ø 6 cm
madera de acacia, con 3 ranuras Ø 6 cm
bois d'acacia, avec 3 encoches Ø 6 cm

	cm	↑ cm	€
00878	31 x 11	2	10,00

passende Schälchen / fitting bowls / cuencos adecuados / bols apropiés



	Ø cm	↑ cm	litr.		€
40685	6	3	0,05	stainless steel	2,00
82316	7	8	0,22	glas	19,70



Besteckbehälter „TIN“

cutlery bin
recipiente
réceptier



Behälter aus Metall mit Tragegriff aus Holz
container made of metal with wooden handle
contenedor de metal con asa de madera
conteneur métallique avec poignée en bois

	cm	↑ cm	€
00014	24,5 x 12	18,5	8,90



Table Caddy „ELEMENT“

table caddy
caddy de mesa
caddy de table



Beton, mit möbelschonender Unterseite
concrete, furniture-friendly underside
hormigón, con base anti rayaduras
béton, avec revêtement antirayures

	cm	↑ cm	inner size cm	€
11647	16,5 x 16	6,5	14,5 x 14	9,90



Table Caddy „ELEMENT“

table caddy
caddy de mesa
caddy de table



Beton, mit möbelschonender Unterseite, 2 Löcher je 6,5 cm
concrete, furniture-friendly underside, 2 holes each 6.5 cm
hormigón, con base anti rayaduras, 2 agujeros cada uno 6,5 cm
béton, avec revêtement antirayures, 2 trous de 6,5 cm chacun

	cm	↑ cm	inner size cm	€
11648	23,5 x 16	6,5	14,5 x 14	14,90



Kerzenleuchter „XXL“

candle holder
candelabro
chandelier



5-flammig, Zinkdruckguss, vernickelt, schwere Ausführung, einfache Montage
5 branches, zinc alloy nickel-plated, heavy model, easy to assemble
5 ramas, fundición de aleación de zinc niquelada, alta calidad y fácil montaje
5 branches, fonte d'alliage de zinc nickelée, haute qualité, facile à monter

	cm	↑ cm		€
04000	46 x 46	56	5-flammig / 5-lids / 5 ramas / 5 branches	114,00
04012	46 x 46	78	5-flammig / 5-lids / 5 ramas / 5 branches	189,00



Kerzenleuchter

candle holder
candelabro
chandelier



hochwertige Gastro Ausführung, möbelschonende Unterseite
heavy quality, with non-scratching undersurface
alta calidad, con base anti raya duras
haute qualité, avec revêtement antirayures

	cm	↑ cm		€
04001	27,5 x 27,5	25	5-flammig / 5-lids / 5 ramas / 5 branches	45,00
04002	27,5 x 11,0	25	3-flammig / 3-lids / 3 ramas / 3 branches	33,00
	Ø cm	↑ cm		€
04003	11	22	1-flammig / 1 lid / 1 rama / 1 branche	22,00
04004	11	10	1-flammig / 1 lid / 1 rama / 1 branche	14,40

**Kerzenleuchter „CLASSIC“, 2er Set**

candle holder, 2 pcs. set
candelabros, set de 2
chandeliers, set de 2



möbelschonende Unterseite
with non-scratching undersurface
con base anti rayaduras
avec revêtement antirayures

	Ø cm	↑ cm	pcs.	€
04035	10	20,5	2	22,00

**Kerzenleuchter „CLASSIC“**

candle holder
candelabro
chandelier



möbelschonende Unterseite
with non-scratching undersurface
con base anti rayaduras
avec revêtement antirayures

	cm	↑ cm		€
04036	22 x 10	22,5	3-flammig / 3-lids / 3 ramas / 3 branches	22,00

**Kerzenleuchter „CLASSIC“**

candle holder
candelabros
chandelier



möbelschonende Unterseite
with non-scratching undersurface
con base anti rayaduras
avec revêtement antirayures

	cm	↑ cm		€
04037	22 x 22	24	5-flammig / 5-lids / 5 ramas / 5 branches	27,50

**Kerzenleuchter „XL“**

candle holder
candelabro
grand chandelier



extra hoch und schwer, möbelschonende Unterseite
extra high and heavy, with non-scratching undersurface
pesado y de alta calidad, con base anti rayaduras
lourd et de haute qualité, avec revêtement antirayures

	cm	↑ cm		€
04005	35 x 13	39	3-flammig / 3-lids / 3 ramas / 3 branches	54,00

**Kerzenleuchter „XL“**

candle holder
candelabro
grand chandelier



extra hoch und schwer, möbelschonende Unterseite
extra high and heavy, with non-scratching undersurface
pesado y de alta calidad, con base anti rayaduras
lourd et de haute qualité, avec revêtement antirayures

	cm	↑ cm		€
04006	35 x 35	39	5-flammig / 5-lids / 5 ramas / 5 branches	68,00

**Kerzenleuchter, 2er Set**

candle holder, 2 pcs. set
candelabros, set de 2
chandeliers, set de 2

**möbelschonende Unterseite**

with non-scratching undersurface
con base anti rayaduras
avec revêtement antirayures

	Ø cm	↑ cm	pcs.	€
04008	6	7	2	9,90

**Kerzenleuchter**

candle holder
candelabro
chandelier

**extra schwerer Fuß, verchromt, möbelschonende Unterseite**

heavy foot, chrome plated, with non-scratching undersurface
pie pesado, asa cromado, con base anti rayaduras
pied lourd, chromé, avec revêtement antirayures

	Ø cm	↑ cm	Farbe / Colour	€
04020	10	11		12,60
04021	10	16		14,80

**Kerzenleuchter**

candle holder
candelabro
chandelier

**Metall hartverchromt, 1-flammig, standsichere Ausführung**

hard chrome plated metal, 1 lid, heavy stable quality
metal duro cromado, 1 brazo, construcción estable
metal chromé dur, 1 flamme, stable

	Ø cm	↑ cm	€
04030	9,5	10	14,00
04031	9,5	16	16,00

**Kerzenleuchter „ELEMENT“**

candle holder
candelabro
chandelier

**Beton, mit möbelschonender Unterseite**

concrete, furniture-friendly underside
hormigón, con base anti rayaduras
béton, avec revêtement antirayures

	Ø cm	↑ cm	€
04027	10	14,5	12,00

**Windlichter, 2er Set**

wind lights, 2 pcs. set
portavelas antiviento, set de 2
porte-bougies anti-vent, set de 2



matt poliert, Gläser satiniert, möbelschonende Unterseite
satin polished finish, glasses satin, with non-scratching undersurface
pulido acabado efecto satinado, cristales satinados, con base anti rayaduras
inox mat satiné et verre mat, avec revêtement antirayures

	Ø cm	↑ cm	pcs.	€
03020	5	15	2	15,40

Ersatzglas / spare glass / cristal de recambio / verre de rechange

	€
03025	2,00

**Windlichter „ELEMENT“, 2er Set**

wind lights, 2 pcs. set
portavelas antiviento, set de 2
porte-bougies anti-vent, set de 2



Beton, Gläser klar, mit möbelschonender Unterseite
concrete, glass clear, with non-scratching undersurface
hormigón, vidrio transparente, con base anti rayaduras
bèton, verre transparente, avec revêtement antirayures

	Ø cm	↑ cm	pcs.	€
03038	6	8	2	12,00

Ersatzglas / spare glass / vidrio de recambio solo / verre de rechange transparent, seul

	Ø cm	↑ cm	€
03098	6	5	2,80

**Windlicht „ELEMENT“**

wind light
porta vela
porte-bougie



Beton, Glas klar, mit möbelschonender Unterseite
concrete, glass clear, with non-scratching undersurface
hormigón, vidrio transparente, con base anti rayaduras
bèton, verre transparente, avec revêtement antirayures

	Ø cm	↑ cm	€
03039	7,5	13	9,00

Ersatzglas / spare glass / vidrio de recambio solo / verre de rechange transparent, seul

	Ø cm	↑ cm	€
03099	7,5	9	3,50

**Windlicht / Tischleuchte**

wind light
porta velas
porte-bougie de table, anti-vent



möbelschonende Unterseite
with non-scratching undersurface
con base anti rayaduras
avec revêtement antirayures

	Ø cm	↑ cm	€
03013	11	22	21,00

Ersatzglas / spare glass / vidrio de recambio solo / verre de rechange transparent, seul

	€
03015	8,20

**Vase mit Glaseinsatz „ELEMENT“**

flower vase with glass insert
florero con tubo de cristal
vase soliflor avec verre



Beton, Glas klar, mit möbelschonender Unterseite, inkl. 2 Ersatzgläsern
concrete, clear glass, furniture-friendly underside, incl. 2 spare glasses
hormigón, cristal incoloro, con base anti rayaduras, incl. 2 tubos de repuesto
béton, verre transparente avec revêtement antirayures y compris 2 verres de rechange

	cm	↑ cm	ml	€
04010	10 x 4,5	12,5	25	6,40

Ersatzglas / spare glass / tubo de recambio / verre de rechange

	Ø cm	↑ cm	ml	€
04011	2,5	11	25	1,20



04015

04016

Vase

flower vase
florero
vase soliflor



Edelstahl-Look, Zinkdruckguss, vernickelt, lackiert, anlaufgeschützt, schwere Ausführung
stainless steel look, heavy zink alloy, nickel plated, laquered
aspecto acero, acabado satinado, alta calidad
aspect inox, fini mat satiné, bonne qualité

	Ø cm	↑ cm	kg	€
04015	4,0	16,5	0,17	13,80
04016	4,5	20,0	0,20	15,40

**Vase**

flower vase
florero
vase soliflor



Edelstahl-Look, Zinkdruckguss, vernickelt, lackiert, anlaufgeschützt, schwere Ausführung
stainless steel look, heavy zink alloy, nickel plated, laquered
aspecto acero, acabado satinado, alta calidad
aspect inox, fini mat satiné, bonne qualité

	Ø cm	↑ cm	kg	€
04017	6,5	18	0,36	16,00



Tischsets

Die umgelegten und angenähten Kanten machen diese Tischsets besonders robust. Geliefert in einer 6er Einheit.

The folded and sewn edges make these table sets particularly robust. Delivered in a packing unit of 6 pieces.

Los bordes doblados y cosidos des los mantelitos los hacen especialmente resistentes. Se entregan en una unidad de embalaje de 6 piezas.

Les bords repliés et cousus rendent ces sets de table en particulièrement robustes. Livré dans un emballage de 6 pièces.



Warenträger - Tischsets

display for table sets
expositor para mantelinas de mesa
présentoir pour sets de table

12 Einschubfächer, komplett auf Rollen, 2 Feststellrollen, Lieferung demontiert

12 shelves, on rolls, 2 rolls to fix, delivery unassembled
12 niveles, 4 ruedas, desmontado (montaje fácil)
12 niveaux, 4 roues, livré démonté

	cm	↑ cm
00401	39,5 x 45	165



60037 - gold

Tischset Feinband

placemat fine band
mantelín cinta fina
set de table, tressage fin



	cm		VE / unit	€ / pc.
60037	45 x 33	gold / gold	6	2,90
60038	45 x 33	beige braun / beige brown	6	2,90
60040	45 x 33	blau / blue	6	2,90

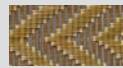

60037 - gold

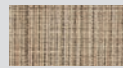

60038 - beige brown

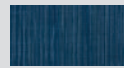

60040 - blue



60502 - grey, beige

Tischset Feinband „TAO“

placemat fine band
mantelín cinta fina
set de table, tressage fin



	cm		VE / unit	€ / pc.
60502	45 x 33	grau, beige / grey, beige	6	3,80
60503	45 x 33	beige / beige	6	3,80
60505	45 x 33	braun / brown	6	3,80



60502 - grey, beige



60503 - beige

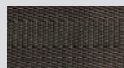

60505 - brown



Tischset „KUNSTLEDER“

placemat
mantelín
set de table



Kunstleder
imitation leather
imitación de cuero
similicuir

	cm		VE / unit	€ / pc.
60044	45 x 32,5	grau / grey	6	9,90
60045	45 x 32,5	braun / brown	6	9,90
60046	45 x 32,5	schwarz / black	6	9,90

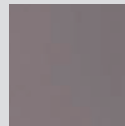

60044 - grey

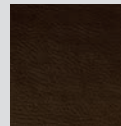

60045 - brown

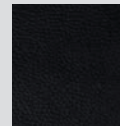

60046 - black



mit Naht rundherum

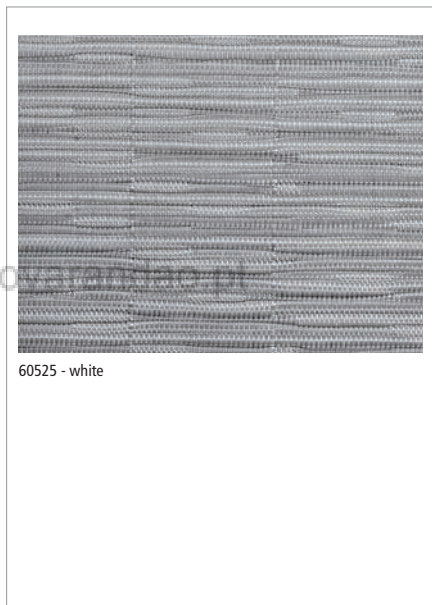

Tischset Schmalband

placemat smallband
mantelín cinta estrecha
set de table tressage étroit



	cm		VE / unit	€ / pc.
60525	45 x 33	weiß / white /	6	2,90
60526	45 x 33	gold / gold /	6	2,90
60527	45 x 33	silber / silver /	6	2,90
60528	45 x 33	grün / green /	6	2,90



60525 - white

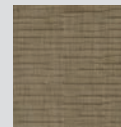

60526 - gold

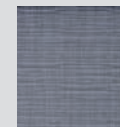

60527 - silver

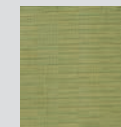

60528 - green

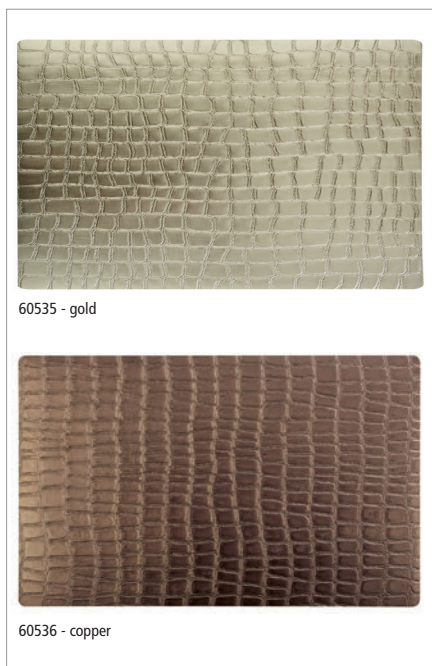

Tischset „CROCO“

placemat
mantelín
set de table



rutschhemmende Unterseite
slip resistant underside
antideslizante por debajo
dessous antiglisse

	cm		VE / unit	€ / pc.
60535	45 x 30	gold / gold	6	5,00
60536	45 x 30	kupfer / copper	6	5,00
60537	45 x 30	braun / brown	6	5,00



60535 - gold

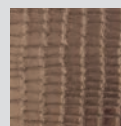

60536 - copper

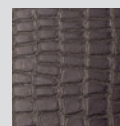

60537 - brown

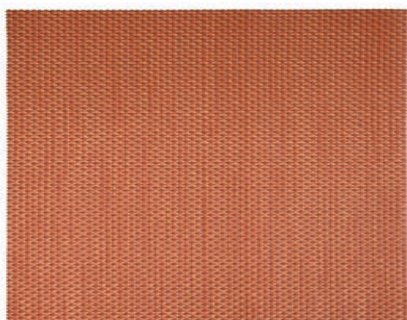

60018 - candyred

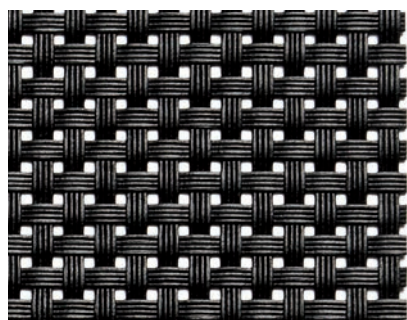

60012 - black

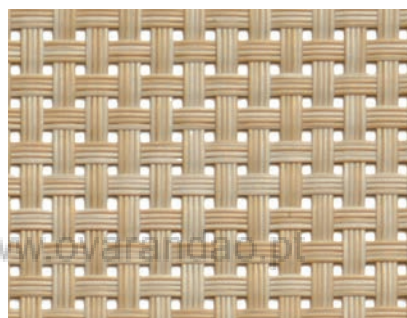

60014 - beige

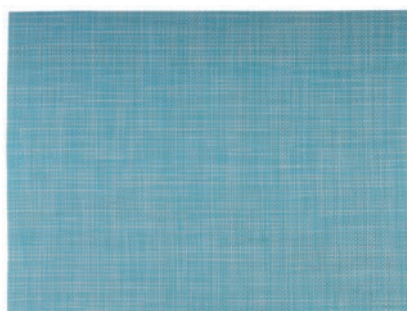

60041 - light blue, white

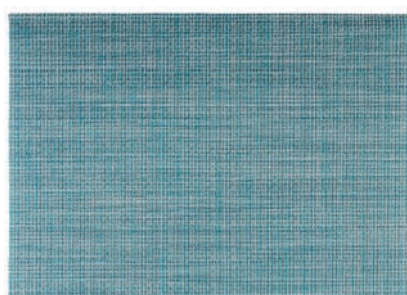

60042 - turquoise, green, white

Tischset Schmalband
 placemat smallband
 mantelín cinta estrecha
 set de table tressage étroit



	cm		VE / unit	€ / pc.
60002	45 x 33	hellblau / light blue	6	2,90
60018	45 x 33	candyrot / candyred	6	2,90
60012	45 x 33	schwarz / black	6	2,90
60014	45 x 33	beige / beige	6	2,90
60015	45 x 33	silbergrau / silvergrey	6	2,90
60016	45 x 33	grün / green	6	2,90
60019	45 x 33	beige braun / beige brown	6	2,90
60522	45 x 33	hellorange / light orange	6	2,90
60520	45 x 33	schwarz weiß / black white	6	2,90
60521	45 x 33	apfelgrün / apple green	6	2,90
60523	45 x 33	violett / purple	6	2,90
60524	45 x 33	platin / platinum	6	2,90
60041	45 x 33	hellblau, weiß / light blue, white	6	2,90

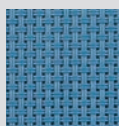

60002 - light blue

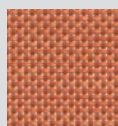

60018 - candyred

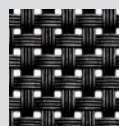

60012 - black



60014 - beige

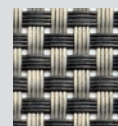

60015 - silvergrey

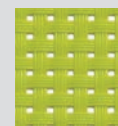

60016 - green



60019 - beige brown



60522 - light orange



60520 - black white

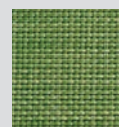

60521 - apple green

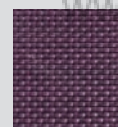

60523 - purple



60524 - platinum

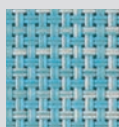

60041 - light blue, white

Tischset Feinband
 placemat fine band
 mantelín cinta fina
 set de table, tressage fin



	cm		VE / unit	€ / pc.
60042	45 x 33	türkis, grün, weiß / turquoise, green, white	6	2,90
60509	45 x 33	Mosaik schwarz, grau / black, grey	6	2,90
60512	45 x 33	schwarz, grau / black, grey	6	2,90
60542	45 x 33	rot / red	6	2,90



60042 - turquoise, green, white

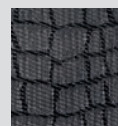

60509 - black, grey

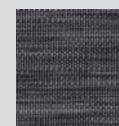

60512 - black, grey



60542 - red

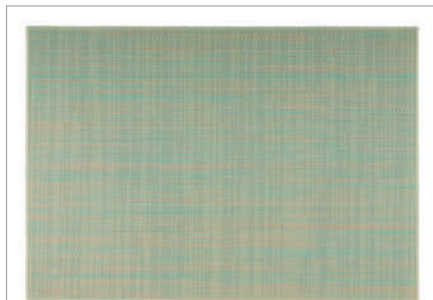

60506 - beige, turquoise



60507 - yellow, light blue

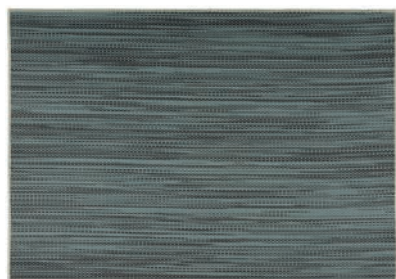

60508 - light blue, dark blue

Tischset Feinband „TAO“

placemat fine band
mantelín cinta fina
set de table, tressage fin



	cm		VE / unit	€ / pc.
60506	45 x 33	beige, türkis / beige, turquoise	6	4,00
60507	45 x 33	gelb, hellblau / yellow, light blue	6	4,00
60508	45 x 33	hellblau, dunkelblau / light blue, dark blue	6	4,00

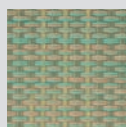

60506 - beige, turquoise



60507 - yellow, light blue

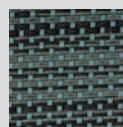

60508 - light blue, dark blue

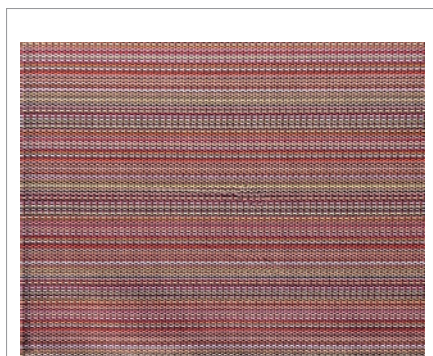

60510 - LINES orange red



60511 - LINES orange, yellow

Tischset Feinband

placemat fine band
mantelín cinta fina
set de table, tressage fin



	cm		VE / unit	€ / pc.
60510	45 x 33	LINES orange, rot / LINES orange red	6	2,90
60511	45 x 33	LINES orange, gelb / LINES orange yellow	6	2,90
60531	45 x 33	LINES schwarz / LINES black	6	2,90
60532	45 x 33	LINES pastell / LINES pastell	6	2,90
60533	45 x 33	LINES bordeaux / LINES bordeaux	6	2,90
60534	45 x 33	LINES rot / LINES red	6	2,90
60530	45 x 33	STRIPES grau / STRIPES grey	6	2,90
60540	45 x 33	FRAMES grau / FRAMES grey	6	2,90
60541	45 x 33	FRAMES schwarz / FRAMES black	6	2,90



60510 - LINES orange red



60511 - LINES orange, yellow

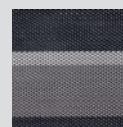

60531 - LINES black

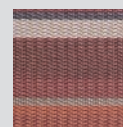

60532 - LINES pastell

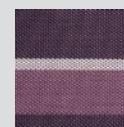

60533 - LINES bordeaux

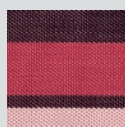

60534 - LINES red

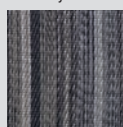

60530 - LINES grey

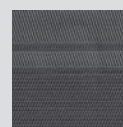

60540 - FRAMES grey

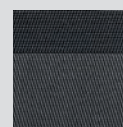

60541 - FRAMES black

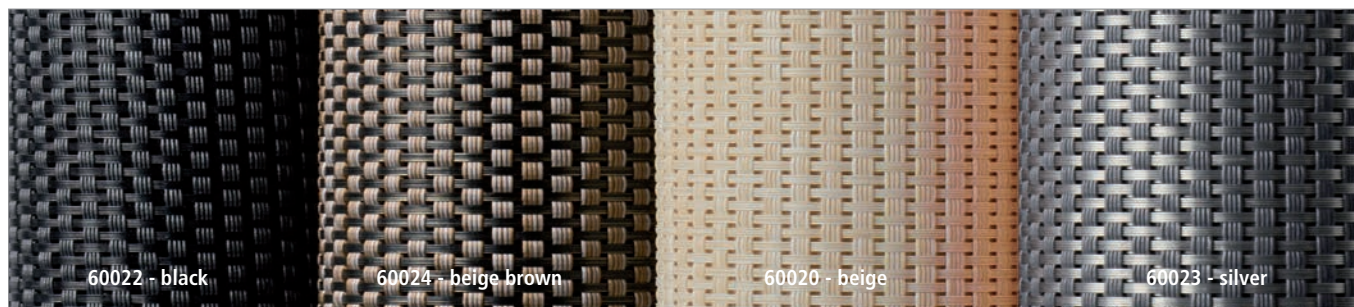

60022 - black

60024 - beige brown

60020 - beige

60023 - silver

Schmalband Tischläufer

table runner fine fabric
camino de mesa
chemin de table

pflegeleichtes Kunststoffgeflecht

easy to clean

fácil de limpiar

nettoyage aisé



	cm		€
60022	45 x 150	schwarz / black	11,90
60024	45 x 150	beige, braun / beige, brown	11,90
60020	45 x 150	beige / beige	11,90
60023	45 x 150	silbergrau / silver grey	11,90



www.ovarandao.pt

www.ovarandao.pt

www.ovarandao.pt



60551

Servietten- und Bestecktaschen, 6er Set

cutlery bag, 6 pcs. set
bolsa cubiertos, set de 6
pochette couverts, set de 6



	cm		pcs.	€ / Set
60551	24 x 9	silbergrau / silvergrey	6	3,90
60550	24 x 9	beige / beige	6	3,90
60552	24 x 9	beige braun / beige brown	6	3,90
60554	24 x 9	platin / platinum	6	3,90



60550 - beige

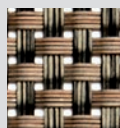

60552 - beige/braun

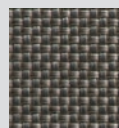

60554 - platin



Körbe

baskets
cestas
corbeilles

Körbe
baskets



SUPERSTRONG



GN 1/1 Korb „SUPERSTRONG“

GN 1/1 basket

GN 1/1 cesta

GN 1/1 corbeille



	cm	↑ cm	GN	Farbe / Colour	€
50640	53 x 32,5	6,5	1/1		24,00
50641	53 x 32,5	10,0	1/1		28,00
50642	53 x 32,5	15,0	1/1		32,00
50643	53 x 32,5	6,5	1/1		24,00
50644	53 x 32,5	10,0	1/1		28,00
50645	53 x 32,5	15,0	1/1		32,00

GN Kuppelhaube / GN cover / GN cúpula / GN cloche bombée

	cm	↑ cm	GN	€
11027	54 x 33	20	1/1	49,00

GN Abdeckhaube / GN cover / GN cubierta / GN cloche

	cm	↑ cm	GN	€
11042	53 x 32,5	9,5	1/1	28,00

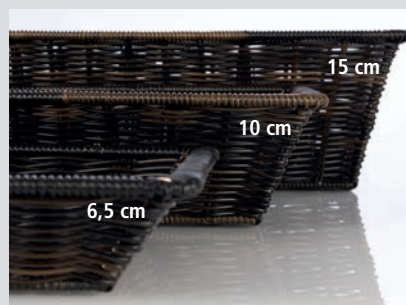

PROFI LINE



50714

50901

50902

Korb "PROFI LINE"

basket baker size
cesta tamaño panaderia
corbeille dimensions „boul-pâte“



	cm	↑ cm	Farbe / Colour	€
50714	30 x 20	5		14,20
50900	40 x 20	5		16,50
50901	40 x 20	5		16,50
50902	40 x 20	5		16,50
50903	40 x 20	5		16,50

www.ovarandao.pt

www.ovarandao.pt



50906

50907

50712

Korb "PROFI LINE"

basket baker size
cesta tamaño panaderia
corbeille dimensions „boul-pâte“



	cm	↑ cm	Farbe / Colour	€
50905	40 x 30	5		19,00
50906	40 x 30	5		19,00
50907	40 x 30	5		19,00
50908	40 x 30	5		19,00

	cm	↑ cm	Farbe / Colour	€
50710	40 x 30	10		19,80
50711	40 x 30	10		19,80
50713	40 x 30	10		19,80
50712	40 x 30	10		19,80



50911

50913

Korb "PROFI LINE"

basket baker size
cesta tamaño panaderia
corbeille dimensions „boul-pâte“



	cm	↑ cm	Farbe / Colour	€
50910	60 x 20	5		20,60
50911	60 x 20	5		20,60
50912	60 x 20	5		20,60
50913	60 x 20	5		20,60

Körbe

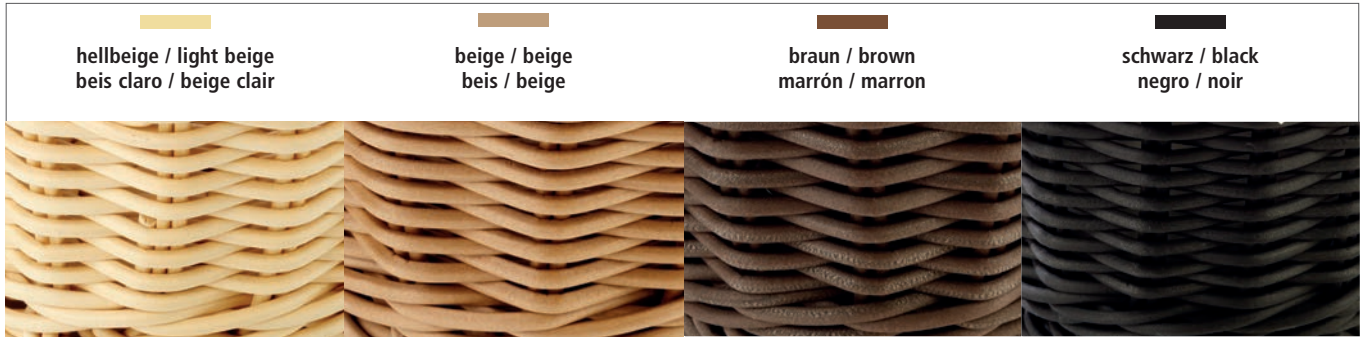

Korb "PROFI LINE"

basket baker size
cesta tamaño panaderia
corbeille dimensions „boul-pâte"



	cm	↑ cm	Farbe / Colour	€
50915	60 x 40	5		30,00
50916	60 x 40	5		30,00
50917	60 x 40	5		30,00
50918	60 x 40	5		30,00



GN 1/1 Korb „PROFI LINE"

GN 1/1 basket
GN 1/1 cesta
GN 1/1 corbeille



	cm	↑ cm	Farbe / Colour	€
50720	53 x 32,5	10		24,00
50721	53 x 32,5	10		24,00
50723	53 x 32,5	10		24,00
50722	53 x 32,5	10		24,00



Korb, rechteckig „PROFI LINE"

basket, rectangular
cesta, rectangular
corbeille, rectangulaire



	cm	↑ cm	Farbe / Colour	€
50700	26,5 x 19	7		9,20
50701	26,5 x 19	7		9,20
50703	26,5 x 19	7		9,20
50702	26,5 x 19	7		9,20

	cm	↑ cm	Farbe / Colour	€
50705	31 x 21	9		10,40
50706	31 x 21	9		10,40
50708	31 x 21	9		10,40
50707	31 x 21	9		10,40



www.ovarandao.pt

Brötchenschütte „PROFI LINE“roll / bun basket
cesta para bollos
corbeille à petits pains

	cm	↑ cm	€
50510	60 x 40	60	122,00

www.ovarandao.pt

www.ovarandao.pt



50500

50501

Stangenbrotkorb „PROFI LINE“baguette basket
cesta de baguette
corbeille à baguettes

	Ø cm	↑ cm	Farbe / Colour	€
50500	28 / 30	38		41,00
50501	28 / 30	38		41,00

www.ovarandao.pt

www.ovarandao.pt



40296

Auslage Tablett flach „PROFI LINE“display tray flat, baker size
bandeja de presentación, tamaño panaderia
plateau de présentation, dimensions „boul-pâte“

	cm	↑ cm	€
40296	40 x 30	1	13,50
40297	60 x 40	1	24,00

www.ovarandao.pt

**Korb, rund „PROFI LINE“**

basket, round
cesta redonda
corbeille ronde



	∅ cm	↑ cm	€
50210	37	9	15,40
50215	42	12	21,00

**Korb, rund „PROFI LINE“**

basket, round
cesta redonda
corbeille ronde



	∅ cm	↑ cm	€
50205	31 / 37	12 / 6	19,80

**Korbschütte, rund „PROFI LINE“**

basket, round
cesta redonda
corbeille ronde



	∅ cm	↑ cm	€
50100	36,5	12,0	26,50
50105	42,0	18,5	28,50
50110	46,0	18,5	36,40

**Systemkorb, gestäbt „PROFI LINE“**

basket
cesta
corbeille



	cm	↑ cm	€
50300	30 x 40	27 / 16	59,00
50305	45 x 40	27 / 16	64,00
50310	60 x 40	27 / 16	69,00

**Systemkorb „PROFI LINE“**

basket
cesta
corbeille



	cm	↑ cm	€
50400	40 x 50	25 / 14	49,90

**Trenner „PROFI LINE“**

divider
divisor
paroi de séparation



	↑ cm	→ cm	€
50315	26 / 15	38	10,00

**Baguette Korb, oval „PROFI LINE“**

baguette basket, oval
cesta de baguette, oval
corbeille à baguettes, ovale



	cm	↑ cm	Farbe / Colour	€
50805	28 x 16	8		8,70
50806	28 x 16	8		8,70
50808	28 x 16	8		8,70
50807	28 x 16	8		8,70

	cm	↑ cm	Farbe / Colour	€
50823	40 x 16	8		11,60

**Korb, oval „PROFI LINE“**

basket, oval
cesta oval
corbeille ovale



	cm	↑ cm	Farbe / Colour	€
50800	25 x 19	6,5		7,80
50801	25 x 19	6,5		7,80
50803	25 x 19	6,5		7,80
50802	25 x 19	6,5		7,80

	cm	↑ cm	Farbe / Colour	€
50815	32 x 23	7		10,00
50816	32 x 23	7		10,00
50818	32 x 23	7		10,00
50817	32 x 23	7		10,00

**Korb, rund „PROFI LINE“**

basket, round
cesta redonda
corbeille ronde



	Ø cm	↑ cm	Farbe / Colour	€
50600	16	8		6,60
50601	16	8		6,60
50603	16	8		6,60
50602	16	8		6,60

	Ø cm	↑ cm	Farbe / Colour	€
50605	20	8		8,70
50606	20	8		8,70
50608	20	8		8,70
50607	20	8		8,70

	Ø cm	↑ cm	Farbe / Colour	€
50610	29	7		10,90
50611	29	7		10,90
50613	29	7		10,90
50612	29	7		10,90



50624

Korb, oval „PROFI LINE“

basket, oval
cesta, oval
corbeille, ovale



	cm	↑ cm	Farbe / Colour	€
50624	19 x 12	6		4,20
50625	19 x 12	6		4,20
50627	19 x 12	6		4,20
50626	19 x 12	6		4,20



50633



50629

Korb, rechteckig „PROFI LINE“

basket, rectangular
cesta rectangular
corbeille rectangulaire



	cm	↑ cm	Farbe / Colour	€
50632	17 x 11	9		4,00
50633	17 x 11	9		4,00
50635	17 x 11	9		4,00
50634	17 x 11	9		4,00

	cm	↑ cm	Farbe / Colour	€
50628	19 x 13	6		4,20
50629	19 x 13	6		4,20
50631	19 x 13	6		4,20
50630	19 x 13	6		4,20



50620

50621

50623

50622

Korb, rund „PROFI LINE“

basket, round
cesta, redonda
corbeille, ronde



	Ø cm	↑ cm	Farbe / Colour	€
50620	13	10		4,20
50621	13	10		4,20
50623	13	10		4,20
50622	13	10		4,20

GN LINE

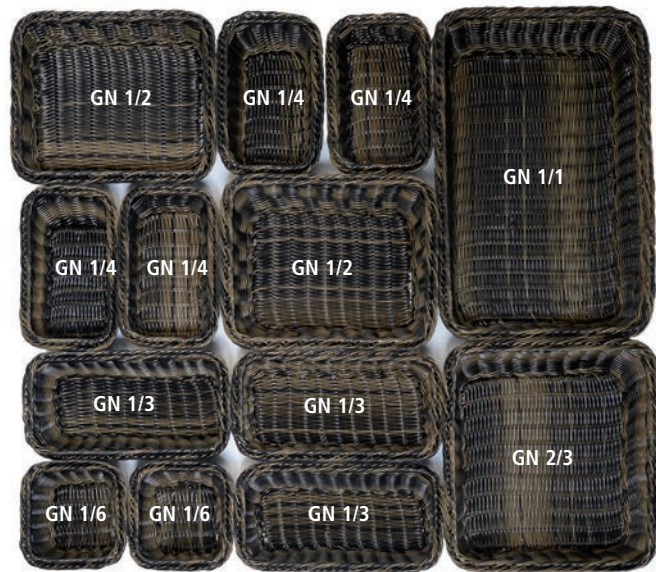
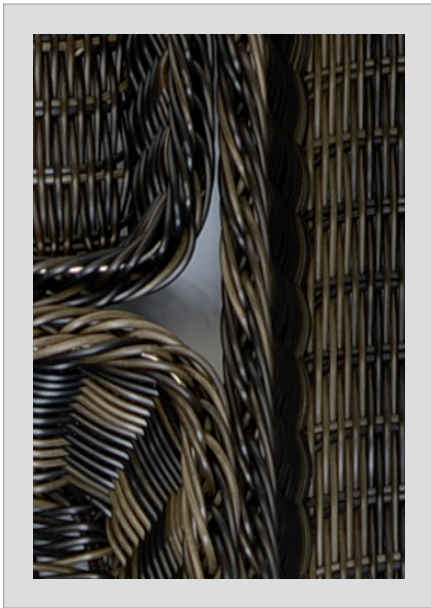

2 Höhen - 6,5 und 10 cm
2 heights - 6,5 and 10 cm



40293
GN 1/1 - 10 cm



40292
GN 1/2 - 10 cm

40225
GN 1/4 - 6,5 cm

Korb „GN LINE“

GN basket
GN cesta
GN corbeille



stabile Ausführung mit Edelstahldraht im Rand zur Stabilisierung
very solid with stainless steel wire frame to stabilize the basket
muy resistente con refuerzo de alambre inox
très résistante avec son fil de renfort inox

	cm	↑ cm	GN	Farbe / Colour	€
40291	53,0 x 32,5	6,5	1/1		18,50
40290	32,5 x 26,5	6,5	1/2		11,50
40223	32,5 x 17,6	6,5	1/3		9,20
40225	26,5 x 16,2	6,5	1/4		7,00
40227	17,6 x 16,2	6,5	1/6		4,70
40229	32,5 x 35,4	6,5	2/3		13,80

	cm	↑ cm	GN	Farbe / Colour	€
40293	53,0 x 32,5	10,0	1/1		23,00
40292	32,5 x 26,5	10,0	1/2		13,80
40243	32,5 x 17,6	10,0	1/3		11,00
40245	26,5 x 16,2	10,0	1/4		8,20
40247	17,6 x 16,2	10,0	1/6		7,00
40249	32,5 x 35,4	10,0	2/3		17,20



GN 1/1

GN 1/1 Besteckbehälter

GN 1/1 dispenser GN
GN 1/1 dispensador de cubiertos
GN 1/1 bac à couverts



in Handarbeit geflochten, 4 Mulden, Kunststoff-Geflecht, Drahtgestell, braun-schwarz
wickerwork, 4 compartments, with reinforced chromed wire structure, brown-black
cesta trensada a mano, 4 compartimentos, de plástico, con bastidor cromado reforzado, marrón oscuro
corbeille tressée à main, 4 compartiments, en plastique, cadre acier chromé renforcé, couleur marron foncé

	cm	↑ cm	GN	Farbe / Colour	€
11966	53 x 32,5	9	1/1		34,00

GN LINE

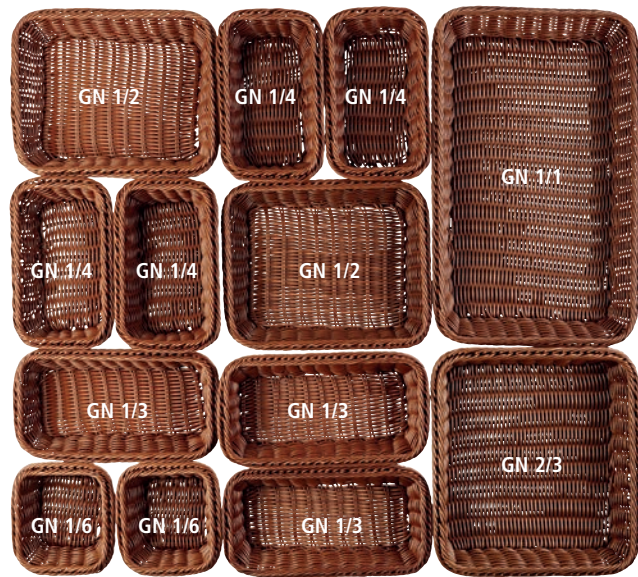
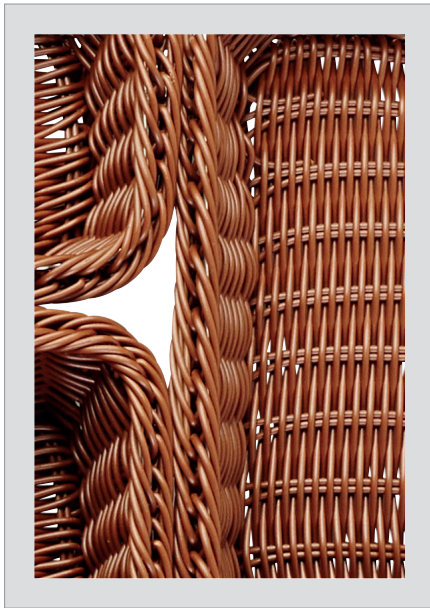

2 Höhen - 6,5 und 10 cm
2 heights - 6,5 and 10 cm



40220
GN 1/1 - 6,5 cm



40222
GN 1/2 - 6,5 cm



40228
GN 1/6 - 6,5 cm



40264
GN 1/4 - 6,5 cm



40272
GN 1/2 - 10 cm

Korb „GN LINE“

GN basket
GN cesta
GN corbeille



stabile Ausführung mit Edelstahldraht im Rand zur Stabilisierung

very solid with stainless steel wire frame to stabilize the basket

muy resistente con refuerzo de alambre inox

très resistente avec son fil de renfort inox

	cm	↑ cm	GN	Farbe / Colour	€
40220	53,0 x 32,5	6,5	1/1		17,20
40222	32,5 x 26,5	6,5	1/2		10,00
40224	32,5 x 17,6	6,5	1/3		8,40
40226	26,5 x 16,2	6,5	1/4		6,50
40228	17,6 x 16,2	6,5	1/6		4,40
40230	32,5 x 35,4	6,5	2/3		13,20

	cm	↑ cm	GN	Farbe / Colour	€
40240	53,0 x 32,5	10	1/1		21,90
40242	32,5 x 26,5	10	1/2		13,40
40244	32,5 x 17,6	10	1/3		10,00
40246	26,5 x 16,2	10	1/4		7,20
40248	17,6 x 16,2	10	1/6		5,90
40250	32,5 x 35,4	10	2/3		16,00

	cm	↑ cm	GN	Farbe / Colour	€
40260	53,0 x 32,5	6,5	1/1		17,20
40262	32,5 x 26,5	6,5	1/2		10,40
40263	32,5 x 17,6	6,5	1/3		8,40
40264	26,5 x 16,2	6,5	1/4		6,50
40266	17,6 x 16,2	6,5	1/6		4,40
40268	32,5 x 35,4	6,5	2/3		13,20

	cm	↑ cm	GN	Farbe / Colour	€
40270	53,0 x 32,5	10	1/1		21,90
40272	32,5 x 26,5	10	1/2		13,40
40274	32,5 x 17,6	10	1/3		10,00
40276	26,5 x 16,2	10	1/4		7,20
40278	17,6 x 16,2	10	1/6		5,90
40280	32,5 x 35,4	10	2/3		16,00

ECONOMIC



Tisch- und Buffetkorb, rund „ECONOMIC“

buffet basket, round
cesta de buffet, redonda
corbeille de buffet, ronde



	Ø cm	↑ cm	Farbe / Colour	€
40132	19,0	9,5		3,80
40135	25,5	8,5		5,20
40144	39,0	10,0		14,20
40191	19,0	9,5		3,80
40192	25,5	8,5		5,20



Tisch- und Buffetkorb, oval „ECONOMIC“

buffet basket, oval
cesta de buffet, oval
corbeille de buffet, ovale



	cm	↑ cm	Farbe / Colour	€
40137	23,0 x 17	8,0		4,20
40139	28,5 x 17	8,5		5,40
40193	23,0 x 17	8,0		4,20
40194	28,5 x 17	8,5		5,40



Tisch- und Buffetkorb, eckig „ECONOMIC“

buffet basket, rectangular
cesta de buffet, rectangular
corbeille de buffet, rectangulaire



	cm	↑ cm	Farbe / Colour	€
40140	23,0 x 17	8		4,20
40159	31,5 x 22	8,5		6,40
40195	23,0 x 17	8		4,20
40196	31,5 x 22	8,5		6,40



GN Buffetkorb „ECONOMIC“

GN basket
GN cesta
GN corbeille



	cm	↑ cm	GN	Farbe / Colour	€
40148	53 x 32,5	8	1/1		25,00



GN Buffetkorb „ECONOMIC“

GN basket
GN cesta
GN corbeille



	cm	↑ cm	GN	Farbe / Colour	€
40152	32,5 x 26,5	8	1/2		9,40



Buffetkorb „ECONOMIC“

buffet basket
cesta de buffet
corbeille de buffet



stabile Ausführung mit Edelstahldraht im Rand zur Stabilisierung
very solid with stainless steel wire frame to stabilize the basket
muy resistente con refuerzo de alambre inox
très résistante avec son fil de renfort inox

	cm	↑ cm	GN	€
40129	53 x 32,5	15,5	1/1	26,00

GN Kuppelhaube / GN cover / GN cúpula / GN cloche bombée

	cm	↑ cm	€
11027	54 x 33	20	49,00



Buffetkorb „ECONOMIC“

buffet basket
cesta de buffet
corbeille de buffet



stabile Ausführung mit Edelstahldraht im Rand zur Stabilisierung
very solid with stainless steel wire frame to stabilize the basket
muy resistente con refuerzo de alambre inox
très résistante avec son fil de renfort inox

	cm	↑ cm	€
40153	45 x 42	17 / 24	25,00



Buffetkorb, rund „ECONOMIC“

buffet basket, round
cesta de buffet, redonda
corbeille de buffet ronde



stabile Ausführung mit Edelstahldraht im Rand zur Stabilisierung
very solid with stainless steel wire frame to stabilize the basket
muy resistente con refuerzo de alambre inox
très résistante avec son fil de renfort inox

	Ø cm	↑ cm	Farbe / Colour	€
40149	40	12,5		18,40
40295	40	12,5		19,80

Rolltophaube / rolltop cover / campana abatible / cloche basculante

	Ø cm	↑ cm		€
18388	38	20	mit verchromtem Kugelgriff with chrome plated handle con pomo cromado / avec bouton chromé	21,00
18387	38	20	mit vergoldetem Kugelgriff / gold plated handle pomo dorado / bouton doré	21,00
18389	38	20	mit verchromtem Designergriff / with chrome plated designer handle	21,00



Buffetkorb „ECONOMIC“

buffet basket
cesta de buffet
corbeille buffet



in Handarbeit geflochten, stabile Ausführung, Edelstahl Fixierungsrahmen,
zur Rutschsicherung, ohne Haube

wickerwork, stainless steel fix the cover, without cover

cesta trensada a mano, con marco cromado patentado para fijar
y encajar la campana (se entrega sin la campana)

corbeille tressée main, cadre fil acier inoxydable pour fixer la cloche (livré sans la cloche)

	cm	↑ cm	Farbe / Colour	€
40150	56,5 x 36	10		30,00
40294	56,5 x 36	10		28,70

GN 1/1 Rolltop-Haube / GN 1/1 rolltop cover / GN 1/1 campana abatible
GN 1/1 cloche basculante

	cm	↑ cm	GN		€
11008	53 x 32,5	19	1/1	vergoldeter Griff / gold plated handle pomo dorado / bouton doré	59,90
11010	53 x 32,5	19	1/1	verchromter Griff / chrome plated handle pomo cromado / bouton chromé	59,90
11018	53 x 32,5	17	1/1	mit verchromtem Designergriff with chrome plated designer handle	62,00



GN Kuppelhaube

GN cover
GN cúpula
GN cloche bombée



glasklarer Kunststoff, Griff verchromt

clear, chrome knob

transparente, asa cromada
transparente, anse chromée

	cm	↑ cm	GN		€
11021	33 x 28	17	1/2	geschlossen / totally closed cerrada / tolement fermée	24,20
11022	33 x 28	17	1/2	mit Front-Ausschnitt / one long side cut out gran apertura frontal / grande ouverture frontale	26,40
11026	54 x 33	20	1/1	geschlossen / totally closed cerrada / tolement fermée	47,00
11027	54 x 33	20	1/1	mit Front-Ausschnitt / one long side cut out gran apertura frontal / grande ouverture frontale	49,00
11028	54 x 33	20	1/1	mit seitlichem Ausschnitt one small side cut out pequeña apertura lateral / petite ouverture latérale	49,00



GN Abdeckhaube

GN cover
GN cubierta
GN cloche



passend für GN Tablets, glasklarer Kunststoff, nahezu unzerbrechlich
suitable for GN trays, clear plastic, nearly unbreakable
apto para bandejas GN, plástico transparente, muy resistente a la rotura
pour bacs et plateaux GN, plastique transparent, très résistant à la casse



	cm	↑ cm	✱ mm	GN	€
11043	32,5 x 17,6	10,5	3	1/3	15,00
11044	53,0 x 16,2	10,5	3	2/4	20,00

	cm	↑ cm	✱ mm	GN	€
11041	32,5 x 26,5	9,5	3	1/2	20,00
11042	53,0 x 32,5	9,5	3	1/1	28,00



Buffetgestell für Körbe

buffet stand for baskets
expositor para cestas
support pour corbeilles



2-stufig, für 2 rechteckige Körbe, platzsparend zusammenklappbar, Lieferung ohne Körbe

2-tier, for 2 rectangular baskets, can be folded, place saving, delivery without baskets

2 alturas, para 2 cestas rectangulares, totalmente plegable para ahorrar espacio, se entrega sin cestas

2 hauteurs, pour 2 corbeilles rectangulaires, pliable pour son rangement, livré sans corbeilles

	cm	↑ cm	€
33221	46 x 24	18 - 21	42,00

Tisch- und Buffetkorb rechteckig „BASIC“ / buffet basket, square / cesta de buffet, cuadrada / corbeille de buffet, carré

	cm	↑ cm	Farbe / Colour	€
30286	30 x 22	7		3,30
30288	40 x 29	7		6,40

Tisch- und Buffetkorb, eckig „ECONOMIC“ / buffet basket rectangular / cesta de buffet, rectangular / corbeille de buffet rectangulaire

	cm	↑ cm	Farbe / Colour	€
40159	31,5 x 22	8,5		6,40

Korb „GN LINE“ / GN basket / GN cesta / GN corbeille

	cm	↑ cm	Farbe / Colour	€
40222	32,5 x 26,5	6,5		10,00
40242	32,5 x 26,5	10,0		13,40
40262	32,5 x 26,5	6,5		10,40
40272	32,5 x 26,5	10,0		13,40



Buffetgestell „DOPPELDECKER“ für GN

buffet frame for GN
estructura para buffet para GN
support buffet pour GN



2-teilig, einfach zusammensetzbar, Etagen-Abstand ca. 26 cm, platzsparend, stabile Ausführung

2 pcs., easy to assemble, distance between the tiers approx. 26 cm, space-saving, robust

2 pzas, fácil de montar, distancia entre pisos aprox. 26 cm, robusto

2 pcs, assemblage facile, distance entre niveaux approx. 26 cm, robuste

	cm	↑ cm	fits to GN	€
11555	50 x 34	37,5	1/1	62,00
11553	29 x 27	35,0	1/2	46,00





Buffetgestell

buffet stand
soporte para buffet
présentoir buffet



3-stufig, geeignet für runde und rechteckige Körbe, platzsparend zusammenklappbar

3-tier, usable for round and rectangular baskets, can be pushed together for place saving

3 alturas, apto para cestas redondas y rectangulares, se puede plegar para ahorrar espacio

3 hauteurs, pour corbeilles rondes ou rectang, la structure s'ouvre ou se ferme pour réduire l'encombrement

	cm	↑ cm	€
33232	59 x 30,5	59	18,50

Tisch- und Buffetkorb, rund „ECONOMIC“ / buffet basket, round / cesta de bufé redonda / corbeille de buffet ronde

	Ø cm	↑ cm	Farbe / Colour	€
40144	39	10		14,20



Baguettekorb „ECONOMIC“

baguette basket
cesta para baguette
corbeille pour baguettes



stabile Ausführung mit Edelstahldraht im Rand zur Stabilisierung

very solid with stainless steel wire frame to stabilize the basket

muy resistente con refuerzo de alambre inox

très résistante avec son fil de renfort inox

	Ø cm	↑ cm	Farbe / Colour	€
40198	35	24 / 42		40,00

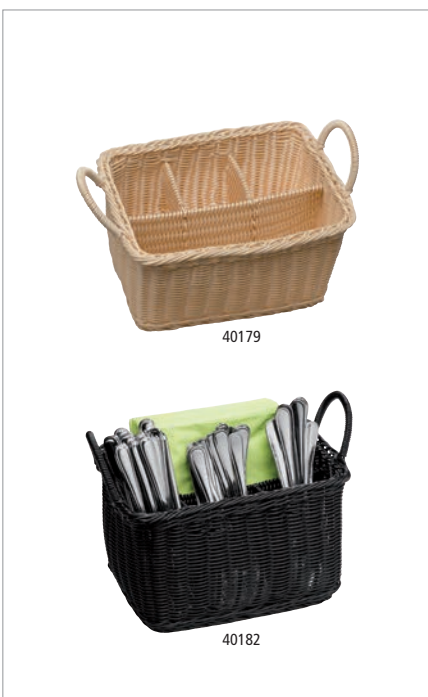

Besteckkorb „ECONOMIC“

cutlery dispenser
dispensador de cubiertos
corbeille à couverts



4 Fächer, 3 kleine Fächer, 1 großes Fach

4 troughs

4 huecos

4 classements

	cm	↑ cm	Farbe / Colour	€
40179	26 x 18	15		11,90
40182	26 x 18	15		11,90

Körbe



Brot- und Obstkorb „WICKER LOOK“

basket for bread or fruits
cesta para pan o fruta
corbeille à pain ou à fruits



	Ø cm	↑ cm	Farbe / Colour	€
40214	20	6,5	■	2,50
40216	23 x 17	6,5	■	2,80

	cm	↑ cm	Farbe / Colour	€
40211	39,5 x 29,5	10	■	6,90
40212	39,5 x 29,5	10	■	6,90
40210	39,5 x 29,5	10	■	6,90



Besteckkorb „ECONOMIC“

cutlery dispenser
dispensador de cubiertos
corbeille à couverts



in Handarbeit geflochten
wickerwork
trensado a mano
tressage à main

	Ø cm	↑ cm	Farbe / Colour	€
40130	12	15	■	3,40
40007	12	15	■	3,40
40012	12	15	■	3,40
40013	12	15	■	3,40



Besteckkorb „ECONOMIC“

cutlery dispenser
dispensador de cubiertos
corbeille à couverts



in Handarbeit geflochten
wickerwork
trensado a mano
tressage à main

	cm	↑ cm	Farbe / Colour	€
40131	27 x 10	4,5	■	3,40
40009	27 x 10	4,5	■	3,40
40010	27 x 10	4,5	■	3,40
40011	27 x 10	4,5	■	3,40



- in Handarbeit geflochten, einfache und leichte Ausführung
- wickerwork, simple and light version
- ligera, trensada a mano
- tressé à main, version légère



hot price

oval

Brot- und Obstkorb oval „BASIC“
basket for bread or fruits
cesta para pan o fruta
corbeille à pain ou à fruits



	cm	↑ cm	€
30279	18 x 12	7	2,30
30280	23 x 15	6	2,40



hot price

oval

Brot- und Obstkorb oval „BASIC“
basket for bread or fruits
cesta para pan o fruta
corbeille à pain ou à fruits



	cm	↑ cm	€
30282	21 x 10	6	2,20
30284	36 x 15	7	3,50



hot price

rund

Brot- und Obstkorb rund „BASIC“
basket for bread or fruits
cesta para pan o fruta
corbeille à pain ou à fruits



	Ø cm	↑ cm	€
30281	20	7	2,40
30285	25	7	3,50



hot price

rechteckig

Tisch- und Buffetkorb rechteckig „BASIC“
buffet basket
cesta de buffet
corbeille de buffet



	cm	↑ cm	€
30286	30 x 22	7	3,30
30288	41 x 29	7	6,40
30283	22 x 15	6	2,70



hot price

quadratisch

Brot- und Obstkorb quadratisch „BASIC“
basket for bread or fruits
cesta para pan o fruta
corbeille à pain ou à fruits



	cm	↑ cm	€
30287	24 x 24	6	3,50

Brottasche

Umgekrempelt kann die Höhe individuell gestaltet werden!



Brottasche

bread basket
panera
corbeille

70% Naturfaser und 30% Kunstharz

70% natural fibre and 30% synthetic resin

70% fibra natural y 30% resina sintética

70% de fibres naturelles et 30% de résine synthétique

	Ø cm	↑ cm	Farbe / Colour	€
30440	17	11		6,80
30450	20	13		7,80
30442	24	24		12,00
30443	30	22		14,00
30441	17	11		6,80
30451	20	13		7,80
30445	24	24		12,00
30446	30	22		14,00



Brottasche

bread basket
panera
corbeille

70% Naturfaser und 30% Kunstharz

70% natural fibre and 30% synthetic resin

70% fibra natural y 30% resina sintética

70% de fibres naturelles et 30% de résine synthétique

	cm	↑ cm	Farbe / Colour	€
30444	30 x 20	18		11,00
30447	30 x 20	18		11,00

umgekrempelt kann die Höhe individuell gestaltet werden

adjustable height by turning the edge upside down

altura ajustable girando el borde al revés

hauteur ajustable en tournant le bord à l'envers



Brottasche
bread basket
panera
corbeille



70% Naturfaser und 30% Kunstharz
70% natural fibre and 30% synthetic resin
70% fibra natural y 30% resina sintética
70% de fibres naturelles et 30% de résine synthétique

	cm	↑ cm	Farbe / Colour	€
30355	12 x 11,5	11,5		5,40
30356	12 x 11,5	13,5		5,40



umgekrempelt kann die Höhe individuell gestaltet werden
adjustable height by turning the edge upside down
altura ajustable girando el borde al revés
hauteur ajustable en tournant le bord à l'envers



Brottasche
bread basket
panera
corbeille



	Ø cm	↑ cm	Farbe / Colour	€
30345	17	11,5		8,00
30346	20	13,5		10,00



schmutzabweisende Kunstfaser, 30°C waschbar
dirt-repellent synthetic fibre, washable 30°C
fibra sintética repelente a la suciedad, lavable a 30°C
fibre synthétique anti-salissante, lavable à 30°C



Brottasche
bread basket
panera
corbeille



	cm	↑ cm	Farbe / Colour	€
30347	19 x 11	10,5		9,00
30348	24 x 16	10,5		11,00



schmutzabweisende Kunstfaser, 30°C waschbar
dirt-repellent synthetic fibre, washable 30°C
fibra sintética repelente a la suciedad, lavable a 30°C
fibre synthétique anti-salissante, lavable à 30°C



30350 rund / round

30371 oval

Brottasche

bread basket
panera
corbeille à pain en toile

BAUM-
WOLLE
COTTON

Baumwolle, umgekrempelt kann die Höhe individuell gestaltet werden, maschinenwaschbar bis 30°C, rund oder oval

cotton, adjustable height, mashine-washable 30°C, round or oval

algodón, altura ajustable, lavable a máquina 30°C, redondo u oval

coton, hauteur ajustable, lavable en machine maxi 30°C, rond ou ovale

	Ø cm	↑ cm	Farbe / Colour	€
30340	17	11		6,50
30350	20	12		7,20
30341	17	11		6,50
30351	20	12		7,20
30360	20 x 15	10		6,90
30370	25 x 18	12		7,70
30361	20 x 15	10		6,90
30371	25 x 18	12		7,70



mit
Zugverschluss

Das Wärmekissen einfach in der Mikrowelle erhitzen (90 Sekunden / 500 Watt)

maschinenwaschbar bis 30°C (außer Kissen)

Brottasche mit Wärmekissen

bread basket with stones pillow
panera con cojín
corbeille à pain en toile avec coussin chauffant

BAUM-
WOLLE
COTTON



Baumwolle, Keramik-Kugeln, maschinenwaschbar bis 30°C

cotton, ceramic stones, mashine-washable 30°C

algodón, bolas de cerámica, lavable a máquina 30°C

coton, billes de céramiques, lavable en machine maxi 30°C

	Ø cm	↑ cm	Farbe / Colour	€
30380	19	23		19,90
30390	19	23		19,90

Wärmekissen / stones pillow / cojín de piedrecillas a calentar / coussin de petites pierres, à chauffer

	Ø cm	↑ cm	€
30385	19	1,5	5,60

**Eierkorb „PROFI LINE“**

egg basket
cesta de huevos
panier à oeufs

PP
POLYPROPYLEN

EDELSTAHL
STAINLESS
INOX



mit Edelstahldraht im Rand, für ca. 20 Eier, hält den Inhalt durch das Stoff-Futter lange warm

willow, stable, for around 20 eggs, keeps eggs warm

ratán, calidad fuerte, para unos 20 huevos, mantiene los huevos calientes

rotin, résistant, belle qualité, pour environ 20 oeufs, pour maintenir les oeufs bien chauds

	Ø cm	↑ cm	Farbe / Colour	€
40299	26	17		16,00

**Eierkorb**

egg basket
cesta de huevos
panier à oeufs

RATTAN
NATUR



stabile Vollweide, für ca. 20 Eier, hält den Inhalt durch das Stoff-Futter lange warm

willow, stable, for around 20 eggs, keeps eggs warm

ratán, calidad fuerte, para unos 20 huevos, mantiene los huevos calientes

rotin, résistant, belle qualité, pour environ 20 oeufs, pour maintenir les oeufs bien chauds

	Ø cm	↑ cm	Farbe / Colour	€
30299	26	17		14,00



Schale

bowl
cuenco
bol



gehämmerte Oberfläche

hammered (surface)
superficie martillada
surface martelée

	cm	↑ cm	ltr.	Farbe / Colour	€
40690	15,5 x 12,0	5,5	0,7	gold look	12,00
40693	23,0 x 15,5	6,0	1,4	gold look	18,00



Schale

bowl
cuenco
bol



gehämmerte Oberfläche

hammered (surface)
superficie martillada
surface martelée

	cm	↑ cm	ltr.	Farbe / Colour	€
40691	15,5 x 12,0	5,5	0,7	copper look	12,00
40694	23,0 x 15,5	6,0	1,4	copper look	18,00



Schale

bowl
cuenco
bol



gehämmerte Oberfläche

hammered (surface)
superficie martillada
surface martelée

	cm	↑ cm	ltr.	Farbe / Colour	€
40692	15,5 x 12,0	5,5	0,7	gunmetal-look	12,00
40695	23,0 x 15,5	6,0	1,4	gunmetal-look	18,00



Servierkorb „BURGER & FRIES“

serving basket
cesta para servir
corbeille de service



Servierkorb aus Metall mit 2 Halter für Dipschälchen

metal serving basket with 2 holders for dip bowls
cesta de metal para servir con 2 soportes para cuencos para dip
corbeille de service en métal avec 2 supports pour ramequins

	cm	↑ cm	€
40604	39,5 x 20	11	7,60

passende Schälchen / fitting bowls / cuencos adecuados / bols apropiés







	Ø cm	↑ cm	ltr.	€
83781	7	3,7	0,05	1,20

Servierbeispiel - Lieferung ohne Schälchen
delivery without bowls



Korb „URBAN“
basket
cesta
corbeille

METALL  

	Ø cm	↑ cm	Farbe / Colour	€
30410	17	7,0		12,80
30411	20	8,5		16,00







Korb „URBAN“
basket
cesta
corbeille



METALL  

	cm	↑ cm	Farbe / Colour	€
30412	21 x 10	7		10,60
30413	30 x 14	12		18,00



GN Korb „URBAN“
GN basket
GN cesta
GN corbeille

METALL    

	cm	↑ cm	GN	Farbe / Colour	€
30414	53,0 x 32,5	7,5	1/1		30,00
30415	32,5 x 26,5	7,5	1/2		23,00
30416	53,0 x 16,2	7,5	2/4		23,00

GN Abdeckhaube / GN cover / GN cubierta / GN cloche

	cm	↑ cm	GN	€
11044	53 x 16,2	10,5	2/4	20,00
11042	53 x 32,5	9,5	1/1	ohne Abbildung 28,00
11022	33 x 28,0	17,0	1/2	ohne Abbildung 26,40
11027	54 x 33,0	20,0	1/1	49,00

**Brot- und Obstkorb „WIRE“**

wire basket
cesta para pan o fruta
corbeille pour pain ou fruits



	Ø cm	↑ cm	Farbe / Colour	€
30205	31	14	metal chrome	14,00

**Brot- und Obstkorb**

basket for bread or fruits
cesta para pan o fruta
corbeille à pain ou à fruits



hochglanzpoliert
mirror polished finish
acabado pulido brillante
brillant

	Ø cm	↑ cm	€
30200	17,5	7,0	12,00
30220	20,5	8,5	15,00
30230	25,5	9,5	16,40

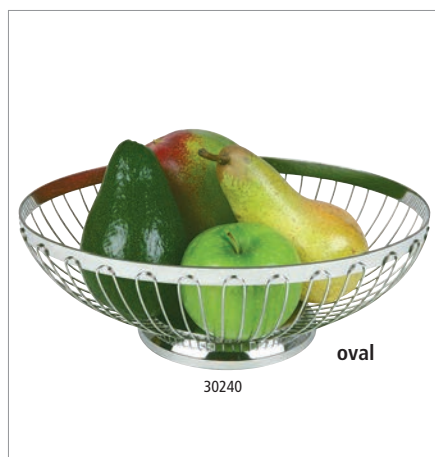
**Brot- und Obstkorb**

basket for bread or fruits
cesta para pan o fruta
corbeille à pain ou à fruits



hochglanzpoliert
mirror polished finish
acabado pulido brillante
brillant

	cm	↑ cm	€
30210	20 x 15	7,0	12,00
30240	24 x 19	8,5	15,00
30250	28 x 21	9,5	16,40

**Obstkorb**

basket for fruits
cesta para fruta
corbeille à fruits



hochglanzpoliert
mirror polished finish
acabado pulido brillante
brillant

	Ø cm	↑ cm	€
30270	21,5	20,5	33,00



Brot- und Obstkorb

basket for bread or fruits
cesta para pan o fruta
corbeille à pain ou fruits



	Ø cm	↑ cm			€
30207	21	16,5	black	copper-look handle	12,00
30208	30	19,0	black	copper-look handle	14,00



Schale

bowl
cuenco
bol



gehämmerte Oberfläche
hammered (surface)
superficie martillada
surface martelée

	cm	↑ cm	litr.	€
40189	20 x 13,5	5,5	0,30	8,00
40190	24 x 16,5	7,0	0,45	10,00



Brot- und Obstschale

bowl for bread or fruits
bol para pan o frutas
bol à pain ou à fruits



hochglanzpoliert, Hammerschlag Optik
mirror polished finish, hammered look
acabado pulido efecto espejo, aspecto repujado
brillant, aspect martelé

	Ø cm	↑ cm	€
30276	16	5,0	3,20
30277	20	5,5	5,40



Edelstahl-Schale

bowl
bandeja ovalada inox
corbeille ovale inox



ingerollter Rand / rolled edge / borde redondeado / bord roulé

	cm	↑ cm	€
40110	26,5 x 18,5	4,0	7,80
40115	31,0 x 21,0	4,5	11,00



Brot- und Obstkorb

basket for bread or fruits
cesta para pan o fruta
corbeille à pain ou fruits



	Ø cm	↑ cm	€
30310	18	7,5	5,70
30320	23	9,0	6,30



15507



15456

15511



15422

15512



15433

15507

Körbe
baskets

Buffetständer / -korb „ASIA PLUS“

buffet stand / basket
soporte para buffet / cesta
présentoir buffet / corbeille



15507

	Ø cm	↑ cm	Farbe / Colour	€
15507	15	10,5		44,00
15510	15	10,5		44,00



15511

Buffetständer / -korb „ASIA PLUS“

buffet stand / basket
soporte para buffet / cesta
présentoir buffet / corbeille



	Ø cm	↑ cm	Farbe / Colour	€
15508	21	10,5		59,00
15511	21	10,5		59,00



15509

Buffetständer / -korb „ASIA PLUS“

buffet stand / basket
soporte para buffet / cesta
présentoir buffet / corbeille



	Ø cm	↑ cm	Farbe / Colour	€
15509	21	20		79,00
15512	21	20		79,00



Korb / Ständer „BASKET“

basket / riser
cesta / soporte
corbeille / support



	Ø cm	↑ cm	Farbe / Colour	€
15321	21 / 15	11		25,00
15325	21 / 15	11		25,00
15323	21 / 15	11		25,00



Korb / Ständer „BASKET“

basket / riser
cesta / soporte
corbeille / support



	Ø cm	↑ cm	Farbe / Colour	€
15320	10,5 / 8	8		14,50
15324	10,5 / 8	8		14,50
15322	10,5 / 8	8		14,50



Korb / Ständer „BASKET“

basket / riser
cesta / soporte
corbeille / support



Chrom poliert
polished chrome
color plata brillante
chrome poli

	Ø cm	↑ cm	Farbe / Colour	€
15331	15	10,5		25,00
15332	21	20,0		40,00



Korb / Ständer „BASKET“

basket / riser
cesta / soporte
corbeille / support



Gold, gebürstet
brushed gold
dorado cepillado
doré brossé

	Ø cm	↑ cm	Farbe / Colour	€
15334	15	10,5		25,00
15335	21	20,0		40,00



Korb / Ständer „BASKET“

basket / riser
cesta / soporte
corbeille / support



	Ø cm	↑ cm	Farbe / Colour	€
15326	21 / 15	21	■	25,00



Box „BROTSTATION“

box
caja de pan para buffet
boîte à pain pour le buffet



Buchen-Holz
beech
haya
hêtre

	cm	↑ cm	€
00959	34 x 26	12,5	50,00
00954	34 x 26	20,0	56,00

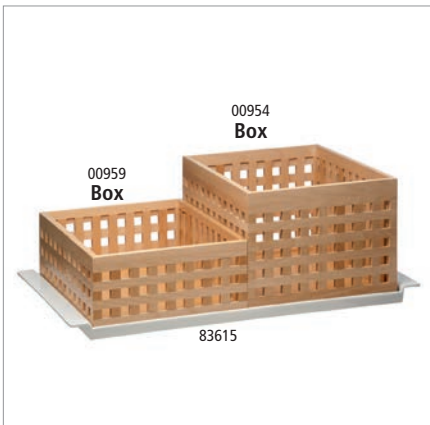

Tablett „BROTSTATION“

tray
bandeja
plateau



Antirutsch-Füßchen
non-slip feet
pies antideslizantes
pieds antidérapants

	cm	↑ cm	€
83615	59,5 x 35,5	3,5	37,00

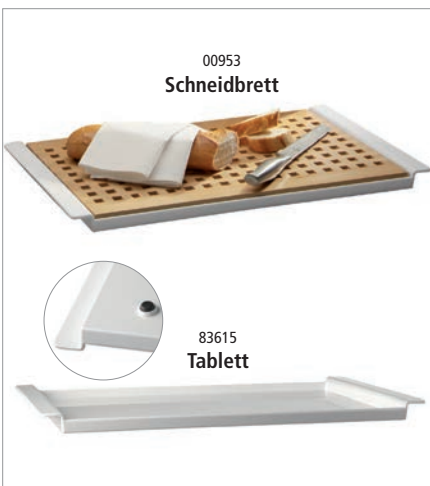

Brot Schneidebrett „BROTSTATION“

cutting board
tabla de corte
planche à découper



Buchen-Holz
beech
haya
hêtre

	cm	↑ cm	€
00953	52 x 34	2	33,00

	cm	↑ cm	€
83615	59,5 x 35,5	3,5	37,00



www.ovarandao.pt

www.ovarandao.pt

www.ovarandao.pt

www.ovarandao.pt

www.ovarandao.pt

www.ovarandao.pt



Chafing Dish, GN Container & Transport

Chafing Dish
Suppentöpfe
Heizelemente
GN-Behälter
Servier-/Transportwagen

chafing dish
soup warmers
heating units
GN-container
serving trolley

chafing dish
marmitas de sopa
resistencias
GN cubetas
carro de servicio

chafing dish
marmites à soup
résistances
GN bacs
chariot de service

EASY INDUCTION



die Deckelbremse sorgt für langsames Schließen

the revolving cover closes gently, thanks to a special built-in axle

sistema de freno para un cierre suave de la tapa

système avec frein pour une fermeture en douceur du couvercle



Druckhebel zum leichten Entnehmen des GN-Behälters

stick for easy removing of the GN-container

dispositivo para levantar y quitar con facilidad la cubeta GN

dispositif pour lever et retirer facilement le bac GN



abnehmbarer Glas-Deckel mit Wasserrücklaufsystem

removable glass lid, with water-runback-system

tapa transparente desmontable con sistema de retorno de la condensación

couvercle transparent amovible avec système de retour de la condensation



Fixierschraube verhindert das Rutschen

fixing screw for skid resistance

Pie trasero anti-deslizante, altura regulable

Pied supplémentaire anti-dérapant réglable en hauteur



Lieferung ohne Induktionskochplatte
delivery without induction plate
se entrega sin placa de inducción
livré sans plaque à induction

GN 1/1 Chafing Dish „EASY INDUCTION“



1 Gestell + 1 Wasserbecken mit Sandwichboden + 1 Deckel mit hydraulischem Gelenk + 1 GN 1/1 Behälter 65 mm tief, hitzebeständige Griffe, hochwertige Verarbeitung, ausschließlich für Induktionskochfelder

1 frame + 1 waterpan with sandwich base + 1 hydraulic cover + 1 GN 1/1 container 65 mm, heat-resistant handles, high quality, only for induction plates

1 marco + 1 baño maría con base sandwich + 1 marco con tapa hidráulica + 1 cubeta GN 1/1 pan 65 mm profundo, asas resistentes al calor, buenos acabados, solamente para inducción

1 pied support + 1 bac bain-marie avec fond sandwich + 1 cadre avec couvercle hydraulique + 1 bac GN 1/1 - 65mm, poignées résistantes à la chaleur, belle qualité, uniquement pour induction

	cm	↑ cm	GN	ltr.	€
12322	60 x 42	30	1/1	9	460,00



Lieferung ohne Induktionskochplatte
delivery without induction plate
se entrega sin placa de inducción
livré sans plaque à induction

GN 2/3 Chafing Dish „EASY INDUCTION“



1 Gestell + 1 Wasserbecken mit Sandwichboden + 1 Wasserbeckenrahmen + 1 Deckel mit hydraulischem Gelenk + 1 GN 2/3 Behälter 65 mm tief, hitzebeständige Griffe, hochwertige Verarbeitung, ausschließlich für Induktionskochfelder

1 frame + 1 waterpan with sandwich base + 1 frame for waterpan + 1 hydraulic cover + 1 GN 2/3 container 65 mm, heat-resistant handles, high quality, only for induction plates

1 marco + 1 baño maría con base sandwich + 1 marco con tapa hidráulica + 1 cubeta GN 2/3 pan 65 mm profundo, asas resistentes al calor, buenos acabados, solamente para inducción

1 pied support + 1 bac bain-marie avec fond sandwich + 1 cadre avec couvercle hydraulique + 1 bac GN 2/3 - 65mm, poignées résistantes à la chaleur, belle qualité, uniquement pour induction

	cm	↑ cm	GN	ltr.	€
12323	42 x 41	30	2/3	5,5	390,00





Lieferung ohne Induktionskochplatte
delivery without induction plate
se entrega sin placa de inducción
livré sans plaque à induction

Chafing Dish „EASY INDUCTION“



1 Gestell + 1 Wasserbecken mit Sandwichboden + 1 Deckel mit hydraulischem Gelenk
+ 1 runder Speisenbehälter, hitzebeständige Griffe, hochwertige Verarbeitung,
ausschließlich für Induktionskochfelder geeignet

1 frame + 1 waterpan with sandwich base + 1 hydraulic cover + 1 round foodpan,
heat-resistant handles, high quality, good for induction plates

1 soporte + 1 baño maría con base sandwich + 1 tapa hidráulica + 1 cubeta redonda,
asas resistente al calor, buen acabado, apto para inducción

1 pied support + 1 bac bain-marie avec fond sandwich + 1 cadre avec couvercle hydraulique +
1 bac rond, poignées résistantes à la chaleur, belle qualité, uniquement pour induction

	cm	↑ cm	ltr.	€
12324	46 x 50	30	6	380,00



Lieferung ohne Induktionskochplatte
delivery without induction plate
se entrega sin placa de inducción
livré sans plaque à induction

Chafing Dish „EASY INDUCTION“



1 Gestell + 1 Wasserbecken mit Sandwichboden + 1 Deckel mit hydraulischem Gelenk +
1 runder Speisenbehälter, hitzebeständige Griffe, hochwertige Verarbeitung,
ausschließlich für Induktionskochfelder geeignet

1 frame + 1 waterpan with sandwich base + 1 hydraulic cover + 1 round foodpan,
heat-resistant handles, high quality, good for induction plates

1 soporte + 1 baño maría con base sandwich + 1 tapa hidráulica + 1 cubeta redonda,
asas resistente al calor, buen acabado, apto para inducción

1 pied support + 1 bac bain-marie avec fond sandwich + 1 cadre avec couvercle hydraulique +
1 bac rond, poignées résistantes à la chaleur, belle qualité, uniquement pour induction

	cm	↑ cm	ltr.	€
12325	48 x 42	39	11	380,00



Induktionskochplatte für Chafing Dish

induction plate for chafing dish
placa de inducción para chafing dish
plaque à induction pour chafing dish

mit Regler
with power control
con control de potencia
avec régulateur

	Ø cm		€
12295	24	900 W	129,00



82210
4,3 ltr.

82215
2 x 2 ltr.

Porzellan-Einsatz

porcelain insert
bandeja de porcelana
bac supérieur en porcelaine



	Ø cm	↑ cm	ltr.	fits to	€
82210	39	6	4,3	12324	70,00
82215	39	6	4,0	12324	72,00

PREMIUM



langlebige Deckelbremse

Abnehmbarer Deckel, dieser lässt sich spielend leicht öffnen und schliessen, der Lauf des Deckels wird professionell gedämpft.

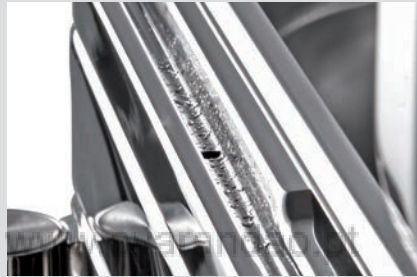

Kondenswasser - Rücklaufsystem

Kondenswasser wird in das Wasserbecken zurückgeführt.



Sandwichboden / Kapselboden

Induktionsfähiger Boden, direkt auf dem Induktionskochfeld einsetzbar. Perfekte Wärmeverteilung und Steuerung.



Fixierschraube / Rutschsicherung

Höhenverstellbares Gelenk, fixiert das Gerät in dem Gestell und auf dem Tisch.



Induktionskochplatte Nr. 12295

Induktionskochplatte wird einfach in das Gestell gelegt.



stapelbar

Chafing Dish Rahmen sind übereinander stapelbar. Platzsparend und rutschfest stapeln und transportieren.



Induktionskochplatte für Chafing Dish

induction plate for chafing dish
placa de inducción para chafing dish
plaque à induction pour chafing dish

mit Regler
with power control
con control de potencia
avec régulateur

	Ø cm		€
12295	24	900 W	129,00



Lieferung ohne Induktionskochplatte
delivery without induction plate
se entrega sin placa de inducción
livré sans plaque à induction

GN 1/1 Chafing Dish „PREMIUM“



1 Gestell + 1 Wasserbecken mit Sandwichboden + 1 Wasserbeckenrahmen + 1 Deckel mit hydraulischem Gelenk + 1 GN 1/1 Behälter 65 mm tief, hitzebeständige Griffe, hochwertige Verarbeitung, ausschließlich für Induktionskochfelder

1 frame + 1 waterpan with sandwich base + 1 frame for waterpan + 1 hydraulic cover + 1 GN 1/1 container 65 mm, heat resistant handles, high quality, only for induction plates

1 soporte + 1 cubeta baño maría con base sandwich + 1 marco para cubeta baño maría + 1 tapa hidráulica + 1 cubeta GN 1/1 de 65 mm, asas resistentes al calor, acabado de alta calidad, solamente para inducción

1 pied support + 1 bac bain-marie avec fond sandwich + 1 cadre pour bac bain-marie + 1 couvercle hydraulique + 1 bac GN 1/1 de 65 mm, poignées résistantes à la chaleur, finition de qualité, uniquement pour induction

	cm	↑ cm	ltr.		€
12370	66 x 48	33	9	mit Edelstahldeckel with stainless steel cover	894,00
12352	66 x 48	33	9	mit Glasdeckel with glass cover	1140,00



Lieferung ohne Induktionskochplatte
delivery without induction plate
se entrega sin placa de inducción
livré sans plaque à induction

Chafing Dish rund „PREMIUM“



1 Gestell + 1 Wasserbecken mit Sandwichboden + 1 Wasserbeckenrahmen + 1 Deckel mit hydraulischem Gelenk + 1 runder Speisenbehälter, hitzebeständiger Griff, hochwertige Verarbeitung, für Induktionskochfelder geeignet

1 frame + 1 waterpan with sandwich base + 1 frame for waterpan + 1 hydraulic cover + 1 round foodpan, heat resistant handle, high quality, suitable for induction plates

1 soporte + 1 cubeta baño maría con base sandwich + 1 marco para cubeta baño maría + 1 tapa hidráulica + 1 cubeta redonda, asa resistente al calor, acabado de alta calidad, apto para inducción

1 pied support + 1 bac bain-marie avec fond sandwich + 1 cadre pour bac bain-marie + 1 couvercle hydraulique + 1 bac rond, poignée résistante à la chaleur, finition de qualité, apte pour induction

	cm	↑ cm	ltr.		€
12371	44 x 54	33	6	mit Edelstahldeckel with stainless cover	780,00
12353	44 x 54	33	6	mit Glasdeckel with glass cover	890,00

Speiseneinsatz / foodpan / cubeta / bac supérieur

	€
12366	24,00



Lieferung ohne Induktionskochplatte
delivery without induction plate
se entrega sin placa de inducción
livré sans plaque à induction

Chafing Dish rund „PREMIUM“



1 Gestell + 1 Wasserbecken mit Sandwichboden + 1 Wasserbeckenrahmen + 1 Deckel mit hydraulischem Gelenk + 1 runder Speisenbehälter, hitzebeständige Griffe, hochwertige Verarbeitung, für Induktionskochfelder geeignet

1 frame + 1 waterpan with sandwich base + 1 frame for waterpan + 1 hydraulic cover + 1 round foodpan, heat resistant handles, high quality, suitable for induction plates

1 soporte + 1 cubeta baño maría con base sandwich + 1 marco para cubeta baño maría + 1 tapa hidráulica + 1 cubeta redonda, asas resistentes al calor, acabado de alta calidad, apto para inducción

1 pied support + 1 bac bain-marie avec fond sandwich + 1 cadre pour bac bain-marie + 1 couvercle hydraulique + 1 bac rond, poignées résistantes à la chaleur, finition de qualité, apte pour induction

	cm	↑ cm	ltr.		€
12372	44 x 48	39	10	mit Edelstahldeckel with stainless cover	780,00
12354	44 x 48	39	10	mit Glasdeckel with glass cover	890,00

Speisenbehälter / foodpan / cubeta superior / bac supérieur

	€
12397	22,00

GLOBE



die Deckelbremse sorgt für langsames Schließen

the revolving cover closes gently, thanks to a special built-in axle

resistencia los frenos del sistema garantizan un cierre suave de la tapa

système avec frein pour une fermeture en douceur du couvercle



abnehmbarer Deckel mit Wasserrücklaufsystem

lid can be taken off, with water runback system

tapa fácil de desmontar, y canal incorporado para recuperar el agua condensada

couvercle facile à démonter, rainure pour récupérer les gouttes de condensation



Kondenswasser wird in das Wasserbecken zurückgeführt

condensed water is led back into the waterpan

el agua de condensación vuelve a la cubeta de agua

l'eau de condensation retourne dans le bac d'eau



für alle Herdarten geeignet, auch für Induktionskochplatten

suitable for all kinds of ovens, even induction cookers

apto para todas las fuentes de calor, incluso inducción

apte pour toutes les sources de chaleur, y compris induction



GN 1/1 Chafing Dish „GLOBE“



hochglanzpoliert, mit abnehmbarem hydraulischen Edelstahl-Deckel, Sandwichboden sorgt für optimale Wärmeleitung, für Induktionsplatten geeignet, Set: Gestell + Wasserbecken + Speisenbehälter GN 1/1 65 mm tief, 9 Liter + Löffelablage + 2 Brennpastenbehälter + Metallrahmen für Induktionskochplatte

mirror polished finish, removable stainless steel hydraulic cover, sandwich base for optimum heat distribution, suitable for induction plates
set: frame + waterpan + GN 1/1 container 65 mm, 9l + cutlery compartment ladles + 2 burner holder + frame for induction plate

pulido brillante, tapa hidráulica de acero inoxidable extraíble, fondo difusor sandwich apto para inducción, incluye: soporte + cubeta baño maría + cubeta GN 1/1 de 65 mm, 9l + soporte para cuchara (sin cuchara) + 2 quemadores + marco para la placa de inducción

poli brilhant, couvercle inox hydraulique amovible, fond diffuseur sandwich apte pour induction, comprend: pied support + bac bain-marie + bac GN 1/1 de 65 mm, 9l + porte-louche (louche non incluse) + 2 brûleurs + cadre inox pour la plaque à induction

	cm	↑ cm	ltr.		€
12394	66,5 x 44	34	9	mit Edelstahldeckel with stainless cover	556,00
12404	66,5 x 44	34	9	mit Glasdeckel with glass cover	556,00
Deckel mit Glasfenster / cover with glass insert / tapa con cristal / couvercle inox et verre					
12391					234,00
Deckel Edelstahl / cover stainless steel / tapa de acero inoxidable / couvercle tout inox					
12386					234,00
Induktionskochplatte für Chafing Dish / induction plate for chafing dish / placa de inducción para chafing dish / plaque à induction pour chafing dish					
12295					129,00
Metallrahmen für Induktionskochplatte / frame for induction plate / estructura o marco para placa de inducción / cadre support inox pour plaque induction					
12296					19,00

**Suppen-Kugel inkl. Gestell „GLOBE“**

soup bowl with stand
cubeta sopa con soporte
récipient à soupe avec pied



hochglanzpoliert, inkl. Speisenbehälter, 1 Brennpastenbehälter, mit einhängbarer Löffelablage, Sandwichboden sorgt für optimale Wärmeverteilung, für Induktionsplatten geeignet, einfaches Anbringen und Entfernen des Deckels, hitzeisolierende Griffe, 1 Metallrahmen für Induktionskochplatten

mirror polished finish, incl. foodpan and 1 burner holder, with fitting compartment for ladles, sandwich bottom for optimum heat distribution, gentle opening of the lid, heat-resistant handles, frame for induction plate

acabado pulido brillante, cubeta sopa inox, 1 quemador, platillo a colgar para el cucharón, fondo difusor sandwich, apto para inducción, tapa con apertura controlada, asas frías, marco para placa de inducción

poli brillant, récipient à soupe inox, 1 brûleur, repose-couvert à accrocher, fond diffuseur sandwich, apte pour induction, couvercle à ouverture contrôlée, anses froides, cadre support inox pour plaque à induction

	Ø cm	↑ cm	ltr.	€
12398	48	45	10	429,00

Induktionskochplatte für Chafing Dish / induction plate for chafing dish / placa de inducción para chafing dish / plaque à induction pour chafing dish

	€
12295	129,00

Metallrahmen für Induktionskochplatten / frame for induction plate / marco para placa de inducción / cadre support inox pour plaque induction

	€
12291	18,00

**Suppen-Kugel „GLOBE“**

soup bowl
cubeta sopa
récipient à soupe



hochglanzpoliert, inkl. Speisenbehälter, mit einhängbarer Löffelablage, Sandwichboden sorgt für optimale Wärmeverteilung, für Induktionsplatten geeignet, einfaches Anbringen und Entfernen des Deckels, hitzeisolierende Griffe (Lieferung ohne Gestell, Löffel)

mirror polished finish, incl. foodpan, with fitting compartment for ladles, sandwich bottom for optimum heat distribution, gentle opening of the lid, heat-resistant handles (delivery without rack, ladle)

acabado pulido brillante, cubeta sopa inox, platillo a colgar para el cucharón, fondo difusor sandwich, apto para inducción, tapa con apertura controlada, asas frías (cucharón no incluido)

poli brillant, récipient à soupe inox, repose-couvert à accrocher, fond diffuseur sandwich, apte pour induction, couvercle à ouverture contrôlée, anses froides (cadre, louche non incluse)

	Ø cm	↑ cm	ltr.	€
12399	48	32	10	374,00

Gestell inkl. Brenner / frame incl. burner / soporte incluyendo quemador / support, brûleur inclus

	€
12396	84,00

Speisenbehälter / foodpan / cubeta superior / bac supérieur

	€
12397	22,00



12393



12403



12390



12295



12291

Chafing Dish „GLOBE“



hochglanzpoliert, mit abnehmbarem hydraulischen Edelstahl-Deckel, Sandwichboden sorgt für optimale Wärmeleitung, für Induktionsplatten geeignet

Set: Gestell + Wasserbecken + Speisenbehälter rund + Löffelablage + Brennpastenbehälter + Metallrahmen für Induktionskochplatte

mirror polished finish, removable hydraulic cover, sandwich base, optimum heat distribution set: frame + waterpan + foodpan round + cutlery compartment ladles + burner holder + frame for induction plate

pulido brillante, con tapa hidráulica extraíble, fondo difusor sandwich apto para inducción. Incluye: 1 pie, 1 cubeta baño maria, 1 cubeta redonda, 1 soporte para cuchara (sin cuchara), 1 quemador, marco inox para la placa de inducción

brillant, couvercle hydraulique amovible, fond diffuseur sandwich apte pour induction. Comprend: pied, cuve bain-marie, bac inox rond, porte-louche (louche non incluse), 1 brûleur, cadre inox pour la plaque à induction

	Ø cm	↑ cm	ltr.		€
12393	38,5	34	6	mit Edelstahldeckel with stainless cover	478,00
12403	38,5	34	6	mit Glasdeckel with glass cover	484,00

Deckel mit Glasfenster / cover with glass insert / tapa con cristal / couvercle inox et verre

12390 220,00 €

Deckel Edelstahl / cover stainless steel / tapa de acero inoxidable / couvercle tout inox

12385 220,00 €

Induktionskochplatte für Chafing Dish / induction plate for chafing dish / placa de inducción para chafing dish / plaque à induction pour chafing dish

12295 129,00 €

Metallrahmen für Induktionskochplatten / frame for induction plate / marco para placa de inducción / cadre support inox pour plaque induction

12291 18,00 €

Speiseneinsatz / foodpan / cubeta / bac supérieur

12366 24,00 €



82210

82215
2 x 2 ltr.

Porzellan-Einsatz

porcelain insert

bandeja de porcelana

bac supérieur en porcelaine



	Ø cm	↑ cm	ltr.	fits to	€
82210	39	6	4,3	12393, 12403	70,00
82215	39	6	4,0	12393, 12403	72,00



GN 2/3 Chafing Dish „GLOBE“



hochglanzpoliert, mit abnehmbarem hydraulischen Edelstahl-Deckel, Sandwichboden sorgt für optimale Wärmeleitung, für Induktionsplatten geeignet, Set: Gestell + Wasserbecken + 1 GN 2/3 Behälter 65 mm tief + Löffelablage + 1 Brennpastenbehälter + 1 Metallrahmen für Induktionskochplatte

mirror polished finish, removable hydraulic cover, sandwich base, optimum heat distribution, set: frame + waterpan + foodpan GN 2/3, 65 mm, 5,5 l + compartment for ladles + burner holder + frame for induction plate

pulido brillante, con tapa hidráulica extraíble, fondo difusor sandwich apto para inducción. Incluye: 1 pie, 1 cubeta baño maría, 1 cubeta GN 2/3 65 mm - 5,5 l, 1 soporte para cuchara (sin cuchara), 1 quemador, marco inox para la placa de inducción

poli brillant, couvercle hydraulique amovible, fond diffuseur sandwich apte pour induction. Comprend: pied, cuve bain-marie, bac inox GN 2/3-65 mm - 5,5 L, porte-louche (louche non incluse), brûleur, cadre inox pour la plaque à induction

	cm	↑ cm	ltr.		€
12483	44 x 41	34	5,5	mit Edelstahl-Deckel with stainless steel cover	498,00
12484	44 x 41	34	5,5	mit Glasdeckel with glass cover	498,00



Rolltop-Chafing Dish „MAESTRO“



Speisenbehälter GN1/1 65 mm tief (passend auch für 100 mm) + Rolltop-Deckel 90° + Wasserbecken inkl. Vorrichtung für Heizplatte + 2 Brennpastenbehälter

foodpan GN1/1 65 mm (also for 100 mm) + rolltop cover 90° + waterpan with screws for heating unit + 2 burner holders

cubeta GN 1/1 - 65 mm (hay espacio para una cubeta 100 mm) + campana rolltop abatible a 90° + 2 quemadores

bac GN 1/1 - 65 mm (accepte aussi bac ht. 100 mm) + couvercle rolltop ouverture 90° + 2 brûleurs

	cm	↑ cm	ltr.	€
12300	67 x 35	45	9	189,00



Rolltop-Chafing Dish „ELITE“



poliert, Rolltop-Deckel klappbar auf 90° und 180°, Speisenbehälter GN 1/1 65 mm tief + Wasserbecken + 2 Brennpastenbehälter, wechseln des GN-Behälters ohne abnehmen des Deckels (kein Kondenswasser-Rücklaufsystem)

polished, rolltop cover adjustable at 90° and 180°, foodpan GN 1/1 65 mm deep + waterpan + 2 burner holders, change of the GN container without removing the lid (condensed water can not be led back into the waterpan)

pulido brillante, tapa rolltop a 90° o 180°, cubeta GN 1/1 + 2 quemadores, cuba baño maría, se puede cambiar la cubeta GN sin retirar la tapa, importante: el agua condensada no revierte en los alimentos

poli brillant, couvercle rolltop ouverture de 90 a 180°, bac GN 1/1, bain-marie, 2 brûleurs, le bac GN peut être retiré et remplacé sans démonter le couvercle, important: la condensation ne retombe pas sur les aliments

	cm	↑ cm	ltr.	€
12350	67 x 47	45	9	229,00

Wasserbecken inkl. Vorrichtung für Heizelement / waterpan / baño maría / bain-marie

	€
12249	44,00



inkl. Vorrichtung für Heizelement
incl. screws for heating unit



inkl. Vorrichtung
für Heizelement
incl. screws
for heating unit



Rolltop-Chafing Dish „CATERER“



Speisenbehälter GN 1/1 65 mm tief + Rolltop-Deckel 90° + Wasserbecken inkl. Vorrichtung für Heizplatte + 2 Brennpastenbehälter (Lieferung ohne Heizplatte), massiver Ständer

foodpan GN 1/1 65 mm deep + rolltop cover 90° + waterpan with screws for heatingunit + 2 burner holders (without heating unit), stable frame

1 cubeta GN 1/1 - 65 mm + campana rolltop abatible a 90° + 2 quemadores + cuba baño maría con fijaciones para resistencia amovible (se sirve sin la resistencia)

1 bac GN 1/1 - 65 mm + couvercle rolltop ouverte 90° + 2 brûleurs + 1 bac bain-marie avec 4 vis pour fixation résistance de chauffe amovible (non include)

	cm	↑ cm	ltr.	€
12245	67 x 35	45	9	219,00

Wasserbecken inkl. Vorrichtung für Heizelement / waterpan / baño maría / bain-marie

12249				44,00
-------	--	--	--	-------



Chafing Dish „CATERER PRO“



Deckel hochglanzpoliert, Deckelgriffe hitzebeständig + 2 Brennpastenbehälter + Wasserbecken, inkl. Vorrichtung für Heizplatte + Gestell mit Deckelhalterung (ohne GN Speisenbehälter)

cover mirror polished finish, cover knob heat-resistant + 2 burner holders + waterpan with screws for heating unit + frame with coverholder (without GN foodpan)

tapa pulido brillante, asas frías + 2 quemadores + cuba inferior con tornillos para resistencia removible (no incluida) + tapa y estructura con sujeción de la tapa (se sirve sin la cubeta GN)

couvercle poli brillant, anses froides + 2 brûleurs + bac bain-marie avec fixations pour résistance amovible (non include)

	cm	↑ cm	€
12233	64 x 35	34	139,00

Ersatzdeckel / replacement cover / tapa de recambio / couvercle de rechange

12236			42,00
-------	--	--	-------

Wasserbecken inkl. Vorrichtung für Heizelement / waterpan / baño maría / bain-marie

12249			44,00
-------	--	--	-------

inkl. Vorrichtung
für Heizelement
incl. screws
for heating unit



Chafing Dish „CATERER“



Speisenbehälter GN 1/1 65 mm tief + 2 Brennpastenbehälter + Wasserbecken inkl. Vorrichtung für Heizelement + Deckel + Gestell mit Deckelhalterung (Lieferung ohne Heizelement)

foodpan GN 1/1 65 mm deep + 2 burner holders + 1 waterpan with screws for heating unit + cover + frame with coverholder (without heating unit)

1 cubeta GN 1/1 - 65 mm + 2 quemadores + cuba baño maría con fijaciones para resistencia amovible + estructura con bloqueo tapa (se sirve sin la resistencia)

1 bac GN 1/1 - 65 mm + 2 brûleurs + 1 bac bain-marie avec 4 vis pour fixation d'une résistance de chauffe amovible (non include) + couvercle + chassis avec blocage couvercle

	cm	↑ cm	ltr.	€
12240	67 x 35	35	9	139,00

Ersatzdeckel / replacement cover / tapa de recambio / couvercle de rechange

12260				44,00
-------	--	--	--	-------

Wasserbecken inkl. Vorrichtung für Heizelement / waterpan / baño maría / bain-marie

12249				44,00
-------	--	--	--	-------

hot price



Chafing Dish „CHEF“



Speisenbehälter GN 1/1 65 mm tief + 2 Brennpastenbehälter + Wasserbecken + Deckel + Gestell mit Deckelhalterung + langer Hohlgriff

foodpan GN 1/1 65 mm + 2 burner holders + waterpan + cove + frame with coverholder

1 cubeta GN 1/1 65 mm + 2 quemadores + cubeta para el agua + tapa y chasis con bloqueo para la tapa

1 bac GN 1/1 - 65 mm + 2 brûleurs + 1 bac bain-marie + couvercle + chassis avec blocage couvercle + poignée tube creux

	cm	↑ cm	ltr.	€
11675	61 x 31	30	9	66,00



Suppentopf „HOT POT“



hot pot / soup pot
olla para buffet
marmite de buffet

Speisenbehälter + Wasserbecken + 1 Brennpastenbehälter + Deckel + Gestell

foodpan + waterpan + 1 burner holder + cover + frame

cubeta + baño maría + 1 quemador + tapa + soporte

réceptient + bain-marie + 1 brûleur + couvercle + support

	Ø cm	↑ cm	ltr.	€
11678	33	35	13,5	79,00

Speisenwärmer „PROFI“



plate warmer
calienta platos
chauffe-plat

Rahmen aus Edelstahl mit Aluminium-Wärmeplatte

stainless steel frame, thick aluminium plate

soporte inox con placa de aluminio

support inox avec plaque aluminium

	cm	↑ cm		€
35050	33 x 18	7	2 Teelichter / 2 tealights 2 velas / 2 bougies	41,00

hot price



Speisenwärmer



warmer
calienta platos
chauffe-plat

3-flammig / 3 lights / 3 velas / 3 bougies

	cm	↑ cm	€
35065	34 x 18	6	17,00

hot price



Speisenwärmer



warmer
calienta platos
chauffe-plat

2-flammig, matt poliert

2 lights, satin polished finish

2 velas, acero inoxidable acabado mate

2 bougies, inox finition mate

	cm	↑ cm	€
35343	34 x 13	6	13,00



Elektro-Rolltop-Chafing Dish „ELITE“

electric rolltop chafing dish
chafing dish eléctrico rolltop
chafing dish électrique rolltop



poliert, Rolltop-Deckel klappbar auf 90° und 180°, Elektro-Wasserbecken mit Temperaturregelung + Speisenbehälter GN 1/1 100 mm tief, 220 - 240 V ~ 50 Hz; 760 - 900 W (kein Kondenswasser-Rücklaufsystem)

polished, rolltop cover adjustable at 90° and 180°, electric waterpan with adjustable heatcontrol + foodpan GN 1/1 100 mm deep, voltage 220 - 240 V ~ 50 Hz, power consumption 760 - 900 W (condensed water cannot be led back into the waterpan)

pulido brillante, tapa abatible apertura a 90° o 180°, baño maría c/ termostato + cubeta GN 1/1 - 100 mm, 220-240 V-50 Hz. Consumo 760-900 W (el agua condensada no gotea dentro de la cubeta)

poli brillant, couvercle rolltop ouverture à 90° ou 180°, bain-marie électrique avec thermostat + bac GN 1/1-100 mm, 220-240 V - 50 Hz; 760-900 W (Important: la condensation ne retombe pas sur les aliments)

	cm	↑ cm	ltr.	€
12360	67 x 47	45	14	376,00



Elektro-Rolltop-Chafing Dish „ELITE“

electric rolltop chafing dish
chafing dish eléctrico rolltop
chafing dish électrique rolltop



poliert, Rolltop-Deckel klappbar auf 90° und 180°, Elektro-Wasserbecken mit Temperaturregelung + Speisenbehälter, 220 - 240 V ~ 50 Hz; 420 - 500 W (kein Kondenswasser-Rücklaufsystem)

polished, rolltop cover adjustable at 90° and 180°, electric waterpan with adjustable heatcontrol + foodpan, voltage 220 - 240 V ~ 50 Hz, power consumption 420 - 500 W (condensed water cannot be led back into the waterpan)

pulido brillante, tapa abatible apertura a 90° o 180°, baño maría c/ termostato - 220-240 V-50 Hz. 420-500 W (el agua condensada no gotea dentro de la cubeta)

poli brillant, couvercle rolltop ouverture à 90° ou 180°, bain-marie électrique avec thermostat, 220-240 V - 50 Hz; 420-500 W (Important: la condensation ne retombe pas sur les aliments)

	Ø cm	↑ cm	ltr.	€
12356	45	45	6,8	270,00

Speisenbehälter / foodpan / cubeta superior / bac supérieur

12357				38,00
-------	--	--	--	-------



Rolltop-Chafing Dish „ELITE“



poliert, Rolltop-Deckel klappbar auf 90° und 180° + Speisenbehälter + Wasserbehälter inkl. Vorrichtung für Heizplatte + 1 Brennpastenbehälter, Hohlgriff kann nicht heiß werden, wechseln des Behälters ohne abnehmen des Deckels (kein Kondenswasser-Rücklaufsystem)

polished, rolltop cover adjustable at 90° and 180° + foodpan + 1 burner holder, waterpan with screws for heating unit (not included), change of the container without removing the lid (condensed water can not be led back into the waterpan)

pulido brillante, tapa rolltop a 90° o 180°, cubeta + 1 quemadores, cuba baño maría con fijaciones para resistencia (se sirve sin la resistencia), se puede cambiar la cubeta GN sin retirar la tapa, importante: el agua condensada no revierte en los alimentos

poli brillant, couvercle rolltop ouverture de 90° a 180°, bac, bain-marie avec 4 vis pour fixation résistance de chauffe amovible (non incluse), 2 brûleurs, le bac GN peut être retiré et remplacé sans démonter le couvercle, important: la condensation ne retombe pas sur les aliments

	Ø cm	↑ cm	ltr.	€
12355	45	45	5	175,00

**Elektro-Chafing Dish „INOXSTAR“**

electric chafing dish
chafing dish eléctrico
chafing dish électrique



poliert, Thermostat-Regelung, Speisenbehälter GN 1/1 100 mm tief, Deckelhalter, 900 W, 230 V
polished, thermostat control, foodpan GN 1/1 100 mm deep, lid holder, 900 W, 230 V
pulido brillante, termostato de control, cubeta GN 1/1-100 mm, bloqueo para la tapa, 900 W, 230 V
poli brillant, thermostat, bac GN 1/1-100 mm, blocage du couvercle, 900 W, 230 V

	cm	↑ cm	ltr.	€
12222	62 x 35	29	13,5	199,00

Deckel / cover / tapa / couvercle

	€
12235	30,00

**Elektro Chafing Dish**

electric chafing dish
chafing dish eléctrico
chafing dish électrique



Speisenbehälter GN 1/1 100 mm tief, Deckelhalter, Thermostat-Regelung 900 W, 230 V
foodpan GN 1/1 100 mm deep, lid holder, thermostat control 900 W, 230 V
cubeta GN 1/1-100 mm, sujeción de la tapa, termostato, 900W, 230 V
bac GN 1/1-100 mm, blocage du couvercle, thermostat, 900W, 230 V

	cm	↑ cm	ltr.	€
12225	63 x 36	29	14	154,00

Deckel / cover / tapa / couvercle

	€
12235	30,00

**Elektro-Chafing Dish „ECO“**

electric chafing dish
chafing dish eléctrico
chafing dish électrique



Deckel poliert, Elektro-Wasserbecken mit Temperaturregelung + Speisenbehälter GN 1/1 65 mm tief, 220 - 240 V ~ 50 Hz; 760 - 900 W
cover polished, electric waterpan with adjustable heatcontrol + foodpan GN 1/1 65 mm deep, voltage 220 - 240 V ~ 50 Hz, power consumption 760 - 900 W
tapa pulido brillante, baño maría c/ termostato + cubeta GN 1/1 - 65 mm - 220-240 V-50 Hz. / 760-900 W
couvercle poli brillant, bain-marie électrique avec thermostat + bac GN 1/1-65 mm, 220-240 V - 50 Hz; 760-900 W

	cm	↑ cm	ltr.	€
12232	63 x 36	29	9	125,00

**Elektro-Chafing Dish „ECO“**

electric chafing dish
chafing dish eléctrico
chafing dish électrique



Glasdeckel (Rand poliert), Elektro-Wasserbecken mit Temperaturregelung + Speisenbehälter, 220 - 240 V ~ 50 Hz; 420 - 500 W
cover polished, electric waterpan with adjustable heatcontrol + foodpan, voltage 220 - 240 V ~ 50 Hz, power consumption 420 - 500 W
tapa vidrio borde pulido brillante, baño maría c/ termostato - 220-240 V-50 Hz. 420-500 W
couvercle verre bord poli brillant, bain-marie électrique avec thermostat, 220-240 V - 50 Hz; 420-500 W

	Ø cm	↑ cm	ltr.	€
12221	36	25	6,8	115,00

hot price

**Elektrischer Suppentopf „ECONOMIC“**

electric soup warmer
marmita de sopa eléctrica
marmite à soupe électrique



Stahl schwarz lackiert, herausnehmbarer Einsatz aus Edelstahl, Temperaturregelung 30°C - 90°C, dreh- und klappbarer Edelstahl-Deckel, inkl. 8 magnetisch haftenden Beschriftungen, 400 W / 230 V

metal, black, removable soup pot, thermostat 30°C - 90°C, st. steel lid, incl. 8 magnetic signs, 400 W / 230 V

metal negro, recipiente sopa inox extraíble, termostato 30°C- 90°C, tapa inox, incluye 8 letreros magnéticos, 400 W / 230 V

acier, noir, récipient à soupe inox amovible, thermostat 30°C - 90°C, couvercle inox, 8 étiquettes magnétiques, 400 W / 230 V

	Ø cm	↑ cm	ltr.	€
11915	32	36	9	105,00

Speisenbehälter / foodpan / recipiente sopa / récipient à soupe

11916	23,00
-------	-------

Deckel / cover / tapa / couvercle

11917	14,90
-------	-------

ohne Wasserbad
without water bath

**Elektrischer Suppentopf**

electric soup warmer
marmita de sopa eléctrica
marmite à soupe électrique



direkte Wärmeübertragung ohne Wasserbad, manuelle Temperaturregelung mit digitalem Anzeigenfenster, Temperatur einstellbar zwischen 60 ° C und 80 ° C, 1000 W / 230 V, herausnehmbarer Einsatz aus Edelstahl, Deckel mit hitzeisoliertem Griff und Löffelaussparung

direct heat transfer without bain marie, manual temperature control with digital display window, temperature adjustable between 60 ° C and 80 ° C, 1000 W / 230 V, removable stainless steel insert, lid with heat insulated handle and notched for spoon

traspaso térmico directo sin baño maría, control manual de la temperatura con ventana de visualización digital, temperatura ajustable entre 60 ° C y 80 ° C, 1000 W / 230 V, inserto de acero inoxidable extraíble, tapa con asas frías y con hueco para la cuchara

transfert direct de chaleur sans bain-marie, contrôle manuel de la température avec fenêtre d'affichage numérique, température réglable entre 60 ° C et 80 ° C, 1000 W / 230 V, insert en acier inoxydable amovible, couvercle avec poignée d'isolation thermique et avec espace pour la louche

	Ø cm	↑ cm	ltr.	€
11903	34,0	33,0	10	130,00

Speisenbehälter / foodpan / recipiente sopa / récipient à soupe

11906	36,00
-------	-------

Deckel / cover / tapa / couvercle

11907	15,00
-------	-------



Elektrischer Suppentopf

electric soup warmer
marmita de sopa eléctrica
marmite à soupe électrique



herausnehmbarer Einsatz aus Edelstahl, elektrisch, mit Wasserbad + Löffel + integrierter Tragering für den Innenbehälter, Deckel mit hitzeisolierendem Griff, Temperaturregelung 80°C (± 10°C), 450-550 W, 230 V

removable soup st. steel pan, bain marie electric, ladle, circular frame, thermostat control till 80°C (± 10°C), 450-550 W, 230 V

recipiente sopa inox extraíble, baño maria eléctrico + cucharón + aro inox, tapa con asas frías, termostato hasta 80°C precisión (± 10°C), 450-550 W, 230 V

réceptif à soupe inox amovible, bain-marie électrique, louche, support circulaire inox, thermostat maxi 80°C (± 10°C), 450-550 W, 230 V

	Ø cm	↑ cm	ltr.	€
11901	38	36,5	10	129,00



Elektrischer Suppentopf

electric soup warmer
marmita de sopa eléctrica
marmite à soupe électrique



herausnehmbarer Einsatz aus Edelstahl, elektrisch, mit Wasserbad + Löffel + integrierter Tragering für den Innenbehälter, Deckel mit hitzeisolierendem Griff, Temperaturregelung 80°C (± 10°C), 400 - 450 W / 220 - 240 V

removable soup st. steel pan, bain marie electric, ladle, st. steel circular frame, thermostat control till 80°C (± 10°C), 400 - 450 W / 220 - 240 V

recipiente sopa inox extraíble, baño maria eléctrico + cucharón + aro inox, tapa con asas frías, termostato hasta 80°C precisión (± 10°C), 400 - 450 W / 220 - 240 V

réceptif à soupe inox amovible, bain-marie électrique, louche, support circulaire inox, thermostat maxi 80°C (± 10°C), 400 - 450 W / 220 - 240 V

	Ø cm	↑ cm	ltr.	€
11910	40	37	10	129,00

Edelstahlgefäß / stainless steel pan / recipiente sopa inox / réceptif à soupe inox

11911	€	50,00
-------	---	-------

Edelstahl-Deckel / stainless steel lid / tapa inox / couvercle inox

11912	€	31,00
-------	---	-------

Elektrokabel / electric cable / cable eléctrico / cable électrique

11913	€	14,00
-------	---	-------



Elektro-Suppenstation

soup warmer
chafing dish doble para sopa
chafing dish 2 soupieres



2 Suppentöpfe + 2 Suppenkellen + Deckelhalter, Thermostat (Überhitzungsschutz), 900 W, 230 V
2 soup pots + 2 soup ladles + lid holder, thermostat control 900 W, 230 V
incluye 2 ollas de sopa + 2 cucharones + bloqueo de la tapa, termostato 900 W, 230 V
2 marmites + 2 louches + bloqueage du couvercle + thermostat, 900 W, 230 V

	cm	↑ cm	ltr.	€
12228	65 x 35,5	31	2 x 4	215,00



Rolltophaube „SWISS“

rolltop-cover
campana rolltop
cloche rolltop



hochglanzpoliert, klappbar auf 90°, nachrüstbar für alle handelsüblichen Chafer
mirror polished finish, cover adjustable at 90°, usable for all commercial chafing dishes
pulido brillante, tapa ajustable 90°, apto para todos los chafings profesionales
poli brillant, ouverture réglable à 90°, apte pour tous les chafings professionnels

	cm	↑ cm	€
12310	55 x 34	19,5	89,00



Bain-Marie Topf

bain marie pot
olla baño Maria
marmite bain-marie



inkl. Deckel, mit Löffelaussparung
included cover, notched for spoon
incluye tapa con hueco para la cuchara
includ le couvercle avec espace pour la louche

	Ø cm	↑ cm	ltr.	€
12244	20	18	4,5	26,00

Deckel / cover / tapa / couvercle

	€
11244	7,50



Bain-Marie Deckel

cover for bain marie
tapa del baño maría
couvercle du bain-marie



	cm	€
12243	54 x 33,5	26,00



12 ltr.

Kaffeedispenser „ROYAL“

coffee dispenser
dispensador de café
distributeur de café



hochglanzpoliert, für warme Getränke, stabil und standfest, inkl. 1 Brennpastenbehälter
mirror polished finish, for warm drinks, solid and stable, incl. 1 burner holder
acabado brillante para bebidas calientes, sólido y estable, incluye un calentador
brillant, pour boissons chaudes, avec 1 brûleur, robuste et stable

	cm	↑ cm	ltr.	€
11667	28 x 28	65	12	256,00



10,5 ltr.

Kaffeedispenser „HAPPY HOUR“

coffee dispenser
dispensador de café
distributeur de café



hochglanzpoliert, für warme Getränke, stabil und standfest, inkl. 1 Brennpastenbehälter
mirror polished finish, for warm drinks, solid and stable, incl. 1 burner holder
acabado pulido brillante para bebidas calientes, sólido y estable, incluye un calentador
brillant, pour boissons chaudes, avec 1 brûleur, robuste et stable

	cm	↑ cm	ltr.	€
11672	31 x 33,5	54,5	10,5	190,00

Hahn / tap / grifo / robinet

	€
11671	25,00

Elektro-Heizelement / heating unit / resistencia / résistance

	cm	↑ cm	€
12287	21 x 20	6	98,00



Einbau-Induktionskochplatte für Chafing Dish

built-in induction plate for chafing dish
placa de inducción para empotrar
plaque à induction à encastrer

inkl. Kabel-Fernbedienung, energiesparend, Leistung in 5 Stufen regelbar, integrierte Lüftung, sehr leise im Betrieb

incl. cable remote control, energy-saving, power adjustable in 5 steps, integrated ventilation, very quiet in operation

incl. mando a distancia con cable, ahorro energético, potencia regulable en 5 pasos, ventilación integrada, funcionamiento silencioso

y compris télécommande filaire, économe en énergie, puissance réglable en 5 étapes, ventilation intégrée, très silencieux en fonctionnement

	cm	↑ cm		€
12285	35,5 x 35,5	6	2000 W	199,00



Induktionskochplatte für Chafing Dish

induction plate for chafing dish
placa de inducción para chafing dish
plaque à induction pour chafing dish

mit Regler

with power control

con control de potencia

avec régulateur

	Ø cm		€
12295	24	900 W	129,00



Metallrahmen für Induktionskochplatten

frame for induction plate
marco para placa de inducción
cadre support inox pour plaque induction



		€
12291	für runde Chafer / for round chafing dish	18,00
12296	für Chafer GN 1/1 / for GN 1/1 chafing dish	19,00



Elektro-Heizelement

heating unit
resistencia
résistance



für Kaffeedispenser (Nr. 11672), 500 W, 220 V, einfach in das Gestell des Dispensers legen

for coffee dispenser (no. 11672), 500 W, 220 V, insert into the frame of the dispenser

para dispensador de café (11672), 500 W, 220V, directamente en el pie del dispensador

pour distributeur à café (11672), 500 W, 220 V, directement dans le support

		€
12287	500 W / 220 V	98,00



Mobile Chafing Dish Heizung

heating element
resistencia
résistance

EDELSTAHL
STAINLESS
INOX

für alle marktgängigen Chafing Dishes

suitable for all current popular chafing dishes, with special spring

para todos los chafing dish más corrientes

pour la plupart des chafing dish les plus courants

	∅ cm	↑ cm		€
12299	14	9 - 11	500 W / 220 V	39,00



Heizplatte durch Spiralfeder an Wasserbad gedrückt
Heizplatte durch Spiralfeder an Wasserbad gedrückt



800 Watt

Elektro-Heizelement

heating unit
resistencia
résistance

ALU
ALUMINIUM



für mehrheitlich geöffnete Chafer GN 1/1 mit einstellbarem Leistungsregler

for GN 1/1 chafer covers are open most of the time, with adjustable control

para GN 1/1 chafing dish abiertos, con termostato

pour chafing dish GN 1/1 dont le couvercle reste souvent ouvert, avec thermostat

		€
12294	800 W / 230 V	170,00



600 Watt

Elektro-Heizelement

heating unit
resistencia
résistance

ALU
ALUMINIUM



für mehrheitlich geöffnetem Chafing Dish GN 1/1

for GN 1/1 chafer covers open most of the time

para chafing dish GN 1/1 con la tapa casi siempre abierta

pur chafing dish GN 1/1 dont le couvercle reste souvent ouvert

		€
12292	600 W / 230 V	128,00



360 Watt

Elektro-Heizelement

heating unit
resistencia
résistance

ALU
ALUMINIUM



für mehrheitlich geschlossene Chafer GN 1/1

for GN 1/1 chafer covers are closed most of the time

para chafing dish GN 1/1 casi siempre cerrados

pour chafing dish GN 1/1 qui restent habituellement fermés

		€
12290	360 W / 140 - 250 V	124,00



Brennpastenbehälter

burner holder
quemador
brûleur

EDELSTAHL
STAINLESS
INOX



mit Bajonettverschluss / bayonet lock / cierre de bayoneta / verrouillage par baionnette

	∅ cm	↑ cm	€
11683	9	6	6,00

**Flasche Brennflüssigkeit „HOT & SAFE“**

bottle fuel

botella de combustible líquido

bouteille de combustible liquide



		litr.	€
00208	1		5,80

**Wärme-Kies**

granite chips

granulado térmico

gravier thermique



für Chafing Dishes, feine Körnung, hohe Wärmespeicherung, kein Verkleben, ideal zum Warmhalten von Eiern

fine for chafing dishes and clean granite chippings, ideal for keeping eggs warm

gravilla de granito fina limpia, ideal para mantener los huevos calientes

gravier fin de granit, lavé, idéal pour maintenir les oeufs au chaud

		kg	€
81116	7		19,00

**Besteckablage**

cutlery rest

reposa cuchara

pose-cuillère



		cm	cm	€
00650	27 x 11	3,5		8,20

**Besteckablage „SPOON“**

cutlery rest

reposa cuchara

pose-cuillère



		cm	cm	€
83801	26 x 10,5	5		6,00

**Besteckablage „BOWL“**

cutlery rest

reposa cuchara

pose-cuillère



		cm	cm	litr.	€
83803	22,5 x 11	6		0,5	6,40

**Besteckablage „SMALL WAVE“**

cutlery rest

reposa cuchara

pose-cuillère



		cm	cm	€
83897	26 x 13	4,5		8,90



GN-Behälter „INDU“

GN container
GN cubeta
GN bac



Behälter mit Keramik-Beschichtung, konstanter Antihaft-Effekt

container with ceramic coating, constant non-stick effect
cubeta con revestimiento cerámico, efecto antiadherente constante
bac avec revêtement céramique, effet anti-adhérent constant

	GN	cm	↑ cm	ltr.	Farbe / Colour	€
88200	1/1	53,0 x 32,5	7,5	7,5		119,00
88201	1/2	32,5 x 26,5	7,5	3,0		69,00
88202	2/3	35,4 x 32,5	7,5	4,5		79,00
88205	1/1	53,0 x 32,5	7,5	7,5		119,00
88206	1/2	32,5 x 26,5	7,5	3,0		69,00
88207	2/3	35,4 x 32,5	7,5	4,5		79,00
88209	1/1	53,0 x 32,5	7,5	7,5		119,00
88210	1/2	32,5 x 26,5	7,5	3,0		69,00
88211	2/3	35,4 x 32,5	7,5	4,5		79,00

		Ø cm	↑ cm	ltr.	Farbe / Colour	€
88204	-	38,5	7,5	6,5		69,00
88208	-	38,5	7,5	6,5		69,00
88212	-	38,5	7,5	6,5		69,00

Hinweis / Note / Remarque / Nota

Antihaffbeschichtung ist nicht schnittfest. Keine scharfen oder spitzen Küchenhelfer verwenden. Ideal ist der Gebrauch von Küchenhelfer aus Holz oder Kunststoff.

Non-stick coating is not cut resistant. Do not use sharp or pointed kitchen utensils. Ideal is the use of kitchen helpers made of wood or plastic.

Le revêtement anti-adhésif n'est pas résistant aux coupures. N'utilisez pas d'ustensiles de cuisine tranchants ou pointus. L'idéal est d'utiliser des aides de cuisine en bois ou en plastique.

El recubrimiento antiadherente no es resistente al corte. No utilice utensilios de cocina afilados o puntiagudos. Lo ideal es el uso de utensilios de cocina de madera o plástico.



GN-Behälter Größen nach EN 631

Alle Behälter sind aus rostfreiem Chrom-Nickel-Edelstahl mit elektrolytisch polierter (seidenmatt) Oberfläche und somit perfekt geeignet für den professionellen Einsatz.

GN-container according to EN 631

All pans are made of chrome/nickel stainless steel with a surface polished by electrolysis (satin-matt) and therefore highly suitable for professional operation.

De conformidad con la norma europea EN 631.

Todos los contenedores están fabricados en acero inoxidable cromado/niquelado con su superficie (satinada) pulida por electrolisis lo que la hace altamente apropiado para el uso profesional.

Bacs GN- Conforme à la norme EN 631

Tous les bacs sont fabriqués en inox/chrome/nickel, surface polie électrolythique (satiné). Approprié pour usage professionnel.

Vorteile der rund geprägten U-Ecken:

- erhöhte Stabilität durch verstärktes Profil
- zielgerechtes und sauberes Ausgießen
- genaue Positionierung der GN-Behälter
- superleichtes Stapeln und Entstapeln
- kein Verkleben der GN-Behälter
- hohe Stoßfestigkeit durch robuste Konstruktion
- ansprechendes Design und stilvoller Blickfang

Advantages of the round-shaped U-Corners:

- increased stability due to the unique construction
- clean ladling and pouring
- exact positioning of the containers
- improved shock-resistance
- appealing design
- no seize of the containers

Ventajas de las esquinas en U:

Perfil reforzado que confiere mayor rigidez y resistencia a la cubeta, diseño para verter fácil y limpiamente, fáciles de apilar y desapilar sin que se claven entre sí, construcción más robusta y resistente a los golpes mecánicos, diseño elegante.

Avantages et fonctionnalité des angles en U:

Profil renforcé pour une meilleure consistance et rigidité du récipient, design qui facilite un versage propre et aisé, permet un empilage et déempilage faciles sans que les bacs restent coincés, meilleure résistance aux chocs mécaniques, seign élégant.

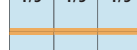
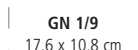
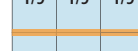
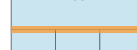
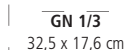
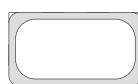
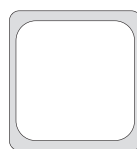
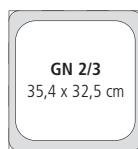
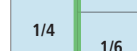
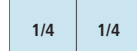
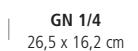
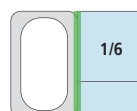
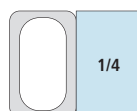
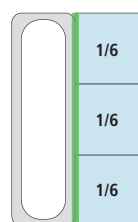
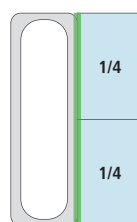
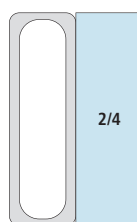
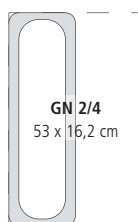
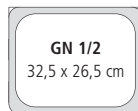
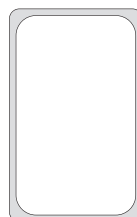



GN-Behälter

GN-container

GN cubetas

GN bacs



81102



81202



81302



81402



81604



81504



81702



81802

	GN	↓ mm	ltr.	cm	€
81000	2/1	20	5,0	53,0 x 65,0	33,10
81095	1/1	10	1,25	53,0 x 32,5	11,90
81100	1/1	20	2,5	53,0 x 32,5	13,30
81101	1/1	40	5,0	53,0 x 32,5	15,00
81109	1/1	55	6,5	53,0 x 32,5	15,60
81102	1/1	65	9,0	53,0 x 32,5	15,85
81104	1/1	100	13,25	53,0 x 32,5	19,60
81106	1/1	150	20,0	53,0 x 32,5	29,50
81108	1/1	200	28,0	53,0 x 32,5	35,65

	GN	↓ mm	ltr.	cm	€
81200	1/2	20	1,0	32,5 x 26,5	5,40
81201	1/2	40	2,0	32,5 x 26,5	8,15
81209	1/2	55	2,8	32,5 x 26,5	8,40
81202	1/2	65	4,0	32,5 x 26,5	8,65
81204	1/2	100	6,0	32,5 x 26,5	11,75
81206	1/2	150	8,75	32,5 x 26,5	18,50
81208	1/2	200	11,65	32,5 x 26,5	23,90

	GN	↓ mm	ltr.	cm	€
81300	1/3	20	0,75	32,5 x 17,6	4,20
81302	1/3	65	2,5	32,5 x 17,6	6,60
81304	1/3	100	4,0	32,5 x 17,6	9,25
81306	1/3	150	5,7	32,5 x 17,6	12,60
81308	1/3	200	7,0	32,5 x 17,6	16,70

	GN	↓ mm	ltr.	cm	€
81400	1/4	20	0,5	26,5 x 16,2	4,40
81401	1/4	40	1,0	26,5 x 16,2	5,00
81402	1/4	65	1,8	26,5 x 16,2	6,00
81404	1/4	100	2,8	26,5 x 16,2	7,90
81406	1/4	150	4,0	26,5 x 16,2	12,10
81408	1/4	200	5,5	26,5 x 16,2	15,10

	GN	↓ mm	ltr.	cm	€
81602	1/6	65	1,0	17,6 x 16,2	4,30
81604	1/6	100	1,6	17,6 x 16,2	6,00
81606	1/6	150	2,4	17,6 x 16,2	9,60
81608	1/6	200	3,0	17,6 x 16,2	11,90

	GN	↓ mm	ltr.	cm	€
81502	1/9	65	0,6	17,6 x 10,8	3,10
81504	1/9	100	1,0	17,6 x 10,8	4,80
81506	1/9	150	1,5	17,6 x 10,8	6,85

	GN	↓ mm	ltr.	cm	€
81700	2/3	20	1,5	35,4 x 32,5	9,50
81701	2/3	40	3,0	35,4 x 32,5	12,60
81702	2/3	65	5,5	35,4 x 32,5	14,60
81704	2/3	100	8,4	35,4 x 32,5	19,20
81706	2/3	150	12,5	35,4 x 32,5	27,85
81707	2/3	200	18,0	35,4 x 32,5	30,00

	GN	↓ mm	ltr.	cm	€
81800	2/4	20	1,2	53,0 x 16,2	8,00
81801	2/4	40	2,4	53,0 x 16,2	10,50
81802	2/4	65	3,6	53,0 x 16,2	12,25
81804	2/4	100	5,6	53,0 x 16,2	17,15
81806	2/4	150	8,7	53,0 x 16,2	20,00



perforierte GN-Behälter

perforated GN-container
cubetas GN perforadas
bacs GN perforés



	GN	↓ mm	cm	€
81911	1/1	40	53,0 x 32,5	15,60
81907	1/1	65	53,0 x 32,5	15,85
81908	1/1	100	53,0 x 32,5	19,60
81909	1/1	150	53,0 x 32,5	29,50
81910	1/1	200	53,0 x 32,5	35,65
81901	1/2	65	32,5 x 26,5	8,65
81902	1/2	100	32,5 x 26,5	11,75
81903	1/2	150	32,5 x 26,5	18,50
81904	1/2	200	32,5 x 26,5	23,90
81905	2/3	65	35,4 x 32,5	14,60
81906	2/3	100	35,4 x 32,5	19,20



GN-Deckel

GN-lid
GN tapa
GN couvercle



ohne Löffelaussparung

without notched edge for spoons
sin agujero para cucharón
sans espace pour louche

	GN	cm	€
81195	1/1	53,0 x 32,5	12,25
81295	1/2	32,5 x 26,5	6,25
81395	1/3	32,5 x 17,6	4,70
81495	1/4	26,5 x 16,2	4,45
81695	1/6	17,6 x 16,2	2,50
81591	1/9	17,6 x 10,8	2,65
81795	2/3	35,4 x 32,5	13,50
81895	2/4	53,0 x 16,2	9,70



GN-Deckel

GN-lid
GN tapa
GN couvercle

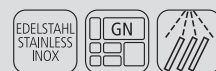

mit Löffelaussparung

with notched edge for spoons
con agujero para cucharón
avec espace pour louche

	GN	cm	€
81191	1/1	53,0 x 32,5	13,30
81292	1/2	32,5 x 26,5	7,00
81391	1/3	32,5 x 17,6	5,30
81492	1/4	26,5 x 16,2	5,00
81692	1/6	17,6 x 16,2	2,95
81595	1/9	17,6 x 10,8	2,80
81791	2/3	35,4 x 32,5	14,60
81891	2/4	53,0 x 16,2	10,80



Die Löffelaussparung mit Prägung verhindert das Zurückfließen von Flüssigkeit auf dem Deckel in den Behälter.

The notch for spoon with embossing prevents liquid on the lid from flowing back into the container.

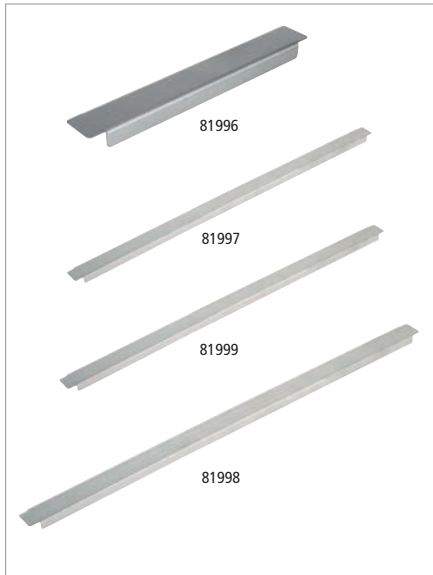

Adapter / Zwischensteg

adapter
adaptador
adaptateur



ermöglicht stabilen Halt von GN-Behältern im CD, rostfreier Chrom-Nickel-Edelstahl
for fixing GN pans, chrome / nickel stainless steel
para sujetar las cubetas GN, acero inox
support stable pour les bacs GN

	cm		€
81996 NEW	15,9	längs bei GN 1/4 / lengthwise GN 1/4 longitud GN 1/4 / GN 1/4 dans la longueur	1,40
81997	17,6	längs bei GN 1/9 / lengthwise GN 1/9 longitud GN 1/9 / GN 1/9 dans la longueur	1,60
81999	32,5	quer bei GN 1/2 / crosswise GN 1/2 de ancho GN 1/2 / GN 1/2 dans la largeur	2,65
81998	53	längs bei GN 1/1 / lengthwise GN 1/1 longitud GN 1/1 / GN 1/1 dans la longueur	4,70



GN Transport-Steck-Deckel

GN-lid with silicone seal
GN tapa hermética con junta
GN couvercle hermétique avec joint



**Silikondichtung, Griffmulde und Loch gegen Unterdruck,
nicht für Kombidämpfer geeignet**

silicone joint, flat handle, vent to compensate
for pressure, not usable for steam oven
junta de silicona, asa empotrada, válvula para compensar
la presión, no se puede utilizar en hornos de vapor
joint silicone, anse encastrée, valve pour compenser la pression

	GN	cm	€
80023	1/1	53,0 x 32,5	29,00
80024	1/2	32,5 x 26,5	18,00
80025	1/3	32,5 x 17,6	15,70
80026	1/4	26,5 x 16,2	13,50
80027	1/6	17,6 x 16,2	11,00
80028	2/4	53,0 x 16,2	26,00
80029	2/3	35,4 x 32,5	28,00



GN Abtropfgitter

GN-drainer
GN escurridor
GN égouttoir



Abtropfgitter aus Edelstahl für Gastronorm Behälter, passend für GN 1/1 und GN 1/2
stainless steel GN drainer for GN 1/1 + GN 1/2
escurridor GN de acero inoxidable para GN 1/1 + GN 1/2
égouttoir GN en acier inoxydable pour GN 1/1 + GN 1/2

	GN	cm	↑ cm	€
81117	1/1	45 x 25	1,5	18,00
81118	1/2	25 x 19	1,5	13,00



GN-Behälter aus Polycarbonat

GN-container polycarbonate
GN cubeta policarbonato
GN bac polycarbonate

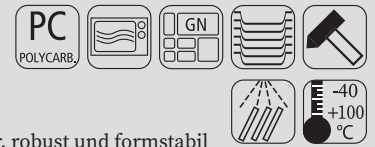

transparent: Inhalt gut erkennbar, Skalierung in Liter, robust und formstabil
transparent: content can be seen, liter scale, solid quality
transparente para ver el contenido, graduación en litros, alta calidad
transparent pour voir le contenu, graduation en litres, haute-qualité

	GN	↓ mm	ltr.	cm	€
82004	1/1	65	8,5	53 x 32,5	13,40
82006	1/1	100	13,0	53 x 32,5	15,40
82008	1/1	150	19,5	53 x 32,5	19,00
82010	1/1	200	26,0	53 x 32,5	25,00

	GN	↓ mm	ltr.	cm	€
82012	1/2	65	3,9	32,5 x 26,5	6,40
82014	1/2	100	5,9	32,5 x 26,5	7,80
82016	1/2	150	8,9	32,5 x 26,5	9,60
82017	1/2	200	11,8	32,5 x 26,5	13,00

	GN	↓ mm	ltr.	cm	€
82018	1/3	65	2,4	32,5 x 17,6	5,40
82020	1/3	100	3,6	32,5 x 17,6	6,40
82022	1/3	150	5,3	32,5 x 17,6	7,80
82023	1/3	200	7,0	32,5 x 17,6	9,60

	GN	↓ mm	ltr.	cm	€
82028	1/4	65	1,7	26,5 x 16,2	4,20
82030	1/4	100	2,5	26,5 x 16,2	5,00
82032	1/4	150	3,7	26,5 x 16,2	8,00
82034	1/4	200	4,8	26,5 x 16,2	9,90

	GN	↓ mm	ltr.	cm	€
82036	1/6	65	1,0	17,6 x 16,2	3,60
82038	1/6	100	1,5	17,6 x 16,2	3,90
82040	1/6	150	2,2	17,6 x 16,2	4,80
82042	1/6	200	2,8	17,6 x 16,2	6,80

	GN	↓ mm	ltr.	cm	€
82050	1/9	65	0,6	17,6 x 10,2	2,60
82051	1/9	100	1,0	17,6 x 10,2	3,00



GN-Deckel

GN-lid
GN tapa
GN couvercle



	GN	cm	€
82001	1/1	53,0 x 32,5	9,00
82013	1/2	32,5 x 26,5	5,00
82019	1/3	32,5 x 17,6	4,00
82029	1/4	26,5 x 16,2	3,20
82037	1/6	17,6 x 16,2	2,50
82059	1/9	17,6 x 10,8	2,20



GN Abtropfgitter

GN drainer
GN escurridor
GN égouttoir



	GN	cm	€
82003	1/1	53,0 x 32,5	6,60
82005	1/2	32,5 x 26,5	3,60
82007	1/3	32,5 x 17,6	2,90



82106



82114



82120



82130



82138



82151

GN-Behälter aus Polypropylen

GN-container polypropylene

GN cubetas polipropileno

GN bacs polypropilène

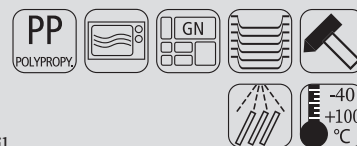

transparent: Skalierung in Liter, robust und formstabil

transparent: liter scale, solid quality

transparente: graduación en litros, alta calidad

transparent: graduation en litres, haute-qualité

	GN	↓ mm	ltr.	cm	€
82104	1/1	65	8,5	53 x 32,5	7,60
82106	1/1	100	13,0	53 x 32,5	8,80
82108	1/1	150	19,5	53 x 32,5	10,00
82110	1/1	200	26,0	53 x 32,5	12,50

	GN	↓ mm	ltr.	cm	€
82112	1/2	65	3,9	32,5 x 26,5	4,10
82114	1/2	100	5,9	32,5 x 26,5	4,80
82116	1/2	150	8,9	32,5 x 26,5	5,80
82117	1/2	200	11,8	32,5 x 26,5	6,80

	GN	↓ mm	ltr.	cm	€
82118	1/3	65	2,4	32,5 x 17,5	3,40
82120	1/3	100	3,6	32,5 x 17,5	4,00
82122	1/3	150	5,3	32,5 x 17,6	5,20
82123	1/3	200	7,0	32,5 x 17,6	6,00

	GN	↓ mm	ltr.	cm	€
82128	1/4	65	1,7	26,5 x 16,2	2,90
82130	1/4	100	2,5	26,5 x 16,2	3,20
82132	1/4	150	3,7	26,5 x 16,2	4,40
82134	1/4	200	4,8	26,5 x 16,2	6,90

	GN	↓ mm	ltr.	cm	€
82136	1/6	65	1,0	17,6 x 16,2	2,40
82138	1/6	100	1,5	17,6 x 16,2	2,80
82140	1/6	150	2,2	17,6 x 16,2	3,20
82142	1/6	200	2,8	17,6 x 16,2	5,80

	GN	↓ mm	ltr.	cm	€
82150	1/9	65	0,6	17,6 x 10,8	2,20
82151	1/9	100	1,0	17,6 x 10,8	2,40



stapelbar
stackable

GN-Deckel

GN-lid

GN tapa

GN couvercle



	GN	cm	€
82101	1/1	53,0 x 32,5	4,30
82113	1/2	32,5 x 26,5	2,50
82119	1/3	32,5 x 17,6	2,10
82129	1/4	26,5 x 16,2	2,00
82137	1/6	17,6 x 16,2	1,90
82159	1/9	17,6 x 10,8	1,80

**GN-Konvektomatenblech**

GN-convection oven trays
GN cubeta para hornos de convección
GN bac pour fours à convection

**Oberfläche mit schwarzer Antihaftbeschichtung, schwere Qualität**

coated black non stick, heavy quality
interior con revestimiento antiadherente negro, alta calidad
revêtement intérieur antiadhérent noir, haute qualité

	GN	↓ mm	cm	€
88246	1/1	20	53 x 32,5	36,60

**GN-Konvektomatenblech - Emailliert**

GN-convection oven trays enamelled
GN cubeta esmaltada para hornos de convección
GN bac émaillé pour fours à convection

**beidseitig beschichtet mit schwarzer Granit-Emaille, gelochte Ecken, schwere Qualität**

both sides coated with black granite enamel, perforated rim corners, heavy gauge
chapa de hierro esmaltada por ambas caras, color granito negro,
borde con ángulos perforados, alta calidad
plaque acier émaillé intérieur et extérieur, granité noir,
bord perforé dans les angles, qualité renforcée

	GN	↓ mm	cm	€
88244	1/1	20	53 x 32,5	23,80
88144	1/1	40	53 x 32,5	26,50
88245	1/1	65	53 x 32,5	28,60

**Backblech**

baking sheet
bandeja pastelera
plaque à pâtisserie

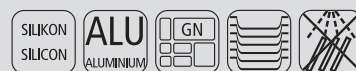

gelocht Ø 3 mm, Materialstärke 1,5 mm, Silikon beschichtet, temperaturbeständig bis 240°C
perforated Ø 3 mm, coated with silicon, heat resistant up to 240°C
aluminio con revestimiento de silicona perforada, resistente hasta 240°
aluminium avec revêtement silicone, perforée, température maxi 240°

	GN	cm	€
88285	1/1	53 x 32,5	29,80

**GN Roste**

GN grid
GN rejilla
GN grille



elektrolytisch poliert, Drahtstärke 3 mm, Rahmendraht 6 mm, extra schwere Qualität
electro-polished, wire thickness 3 mm, frame wire 6 mm, extra heavy quality
inox pulido electrolítico, grosor alambre 3 mm, grosor marco 6 mm, calidad reforzada
inox poli électrolytique, fil 3 mm, cadre 6 mm, qualité renforcée

	GN	cm	€
81199	2/1	65,0 x 53,0	41,00
81198	1/1	53,0 x 32,5	18,90
81796	2/3	32,5 x 35,4	12,50
81296	1/2	32,5 x 26,5	10,00

**GN 1/3 Bestecksammler**

GN 1/3 container
GN 1/3 cubeta
GN 1/3 bac

**mit 2 Haken zum Einhängen an Servier- oder Transportwagen**

container with 2 hooks, to hang on trolleys for cutlery
cubeta con 2 ganchos para cubiertos, a colgar del carro
bac à couverts avec 2 crochets, à accrocher au chariot

	GN	↓ mm	cm	€
11978	1/3	150	32,5 x 17,5	18,00



GN-Behälter

GN-container
GN cubetas
GN bac



	GN	↓ mm	ltr.	cm	€
82100	1/1	60	7,1	53,0 x 32,5	51,00
82200	1/2	60	3,4	32,5 x 26,5	24,00
82300	1/3	60	2,0	32,5 x 17,6	18,00
82306	2/3	60	4,6	35,4 x 32,5	34,00
82301	2/4	60	3,0	53,0 x 16,2	32,00



GN Tablett „FRAMES“

GN tray
GN bandeja
GN plateau



	GN	↑ cm	cm	€
82355	1/1	2	53,0 x 32,5	35,00
82356	1/2	2	32,5 x 26,5	20,00
82357	1/3	2	32,5 x 17,6	17,00



GN Tablett

GN tray
GN bandeja
GN plateau



	GN	↑ cm	cm	€
82201	1/1	2,5	53,0 x 32,5	36,00
82202	1/2	2,5	32,5 x 26,5	20,00
82203	1/3	2,5	32,5 x 17,6	17,00
82204	2/4	2,5	53,0 x 16,2	28,00
82205	2/3	2,5	35,4 x 32,5	30,00



GN 1/1 Buffet-Set „CATERER“

GN 1/1 buffet set
GN 1/1 set de bufé
GN 1/1 set catering: plateau + cloche



2-teilig: Tablett + Haube, Tablett fixiert sich auf der Haube - kein Rutschen möglich
2 pcs. set: tray + cover, tray fixes itself on the cover and can not slip off
set de 2: bandeja + tapa, la bandeja encaja encima de la tapa para que no se deslice
set de 2: plateau GN 1/1 réf. + cloche spéciale empilement stable

	cm	↑ cm	GN	fits to	€
11195	53 x 32,5	10,5	1/1	82201, 82355	63,70



hot price

GN 2/4

GN 1/1

GN 1/2

GN 1/4

GN 1/6

GN-Behälter „ECOLINE“

GN container

GN cubeta

GN bac



mit Stapelnocke

with notching edge

con borde marcado para el apilado

avec rebord pour l'empilage

	GN	↓ mm	ltr.	cm	Farbe / Colour	€
83759	1/1	65	7,10	53,0 x 32,5		29,40
83755	2/4	65	3,00	53,0 x 16,2		20,00
83757	1/2	65	3,40	32,5 x 26,5		16,80
83753	1/3	65	2,00	32,5 x 17,6		14,50
83751	1/4	65	1,35	26,5 x 16,2		13,00
83749	1/6	65	0,80	17,6 x 16,2		10,40

	GN	↓ mm	ltr.	cm	Farbe / Colour	€
83758	1/1	65	7,10	53,0 x 32,5		29,40
83754	2/4	65	3,00	53,0 x 16,2		20,00
83756	1/2	65	3,40	32,5 x 26,5		16,80
83752	1/3	65	2,00	32,5 x 17,6		14,50
83750	1/4	65	1,35	26,5 x 16,2		13,00
83748	1/6	65	0,80	17,6 x 16,2		10,40

	GN	↓ mm	ltr.	cm	Farbe / Colour	€
84300	1/1	100	10,6	53,0 x 32,5		34,00
84302	2/4	100	4,3	53,0 x 16,2		25,00
84301	1/2	100	4,7	32,5 x 26,5		20,50
84303	1/3	100	2,7	32,5 x 17,6		16,80
84304	1/4	100	1,9	26,5 x 16,2		14,60
84305	1/6	100	1,0	17,6 x 16,2		11,20

	GN	↓ mm	ltr.	cm	Farbe / Colour	€
84306	1/1	100	10,6	53,0 x 32,5		34,00
84308	2/4	100	4,3	53,0 x 16,2		25,00
84307	1/2	100	4,7	32,5 x 26,5		20,50
84309	1/3	100	2,7	32,5 x 17,6		16,80
84310	1/4	100	1,9	26,5 x 16,2		14,60
84311	1/6	100	1,0	17,6 x 16,2		11,20



GN-Deckel

GN-lid

GN tapa

GN couvercle



	GN	cm	€
82001	1/1	53,0 x 32,5	9,00
82013	1/2	32,5 x 26,5	5,00
82019	1/3	32,5 x 17,6	4,00
82029	1/4	26,5 x 16,2	3,20
82037	1/6	17,6 x 16,2	2,50

**GN-Behälter „HIGHLINE“**

GN-container
GN cubeta
GN bac



extrem bruchsticher, glänzende und harte Oberfläche, tiefkühlfest, keinen Temperaturschocks unterziehen, nicht auf heißen Flächen liegen lassen, mit Stapelnocke

durable, top quality, hard and glossy surface, avoid thermal shocks, do not leave on hot surfaces, with notching edge

duradera, alta calidad, superficie brillante y resistente, hay que evitar los cambios térmicos bruscos, no apoyar en superficies calientes, con borde para apilamiento

durable, haute qualité, surface brillante et résistante, éviter les chocsthermiques et ne pas poser sur une surface chaude, encoche pour une louche

	GN	↓ mm	ltr.	cm	€
83772	1/1	65	7,10	53,0 x 32,5	36,00
83770	2/3	65	4,60	35,0 x 32,5	32,50
83768	1/2	65	3,40	32,5 x 26,5	20,00
83766	2/4	65	3,00	53,0 x 16,2	23,50
83764	1/3	65	2,00	32,5 x 17,6	15,50
83762	1/4	65	1,35	26,5 x 16,2	14,50
83760	1/6	65	0,80	17,6 x 16,2	11,00

	GN	↓ mm	ltr.	cm	€
83773	1/1	100	11,0	53,0 x 32,5	41,00
83769	1/2	100	5,50	32,5 x 26,5	23,40
83765	1/3	100	3,15	32,5 x 17,6	18,00
83763	1/4	100	2,20	26,5 x 16,2	16,00
83761	1/6	100	1,25	17,6 x 16,2	12,40



11302

GN 1/1, 2-tlg. Set: Tablett + Haube**GN 1/1 Buffet-Set „HOCHSTAPLER“**

GN 1/1 buffet set
GN 1/1 set de bufé

GN 1/1 kit catering plateau + cloche



2-teilig: Tablett + Haube, Tablett fixiert sich auf der Haube - kein Rutschen möglich

2 pcs. set: tray + cover, tray fixes itself on the cover and can not slip off

set de 2 piezas: bandeja + tapa, la bandeja encaja encima de la tapa para que no se deslice

ensemble de 2 pièces: plateau GN 1/1 réf. + cloche spéciale empilement stable

	cm	↑ cm	GN	€
11302	53 x 32,5	10,5	1/1	68,00

**System-Haube für stapelbare Tablett
wie 11300, 11290 oder 11295**



GN 1/2

11041

GN 1/1

11042

GN Abdeckhaube

GN cover
GN cubierta
GN cloche



	cm	↑ cm	* mm	GN	€
11041	32,5 x 26,5	9,5	3	1/2	20,00
11042	53,0 x 32,5	9,5	3	1/1	28,00
11043	32,5 x 17,6	10,5	3	1/3	15,00
11044	53,0 x 16,2	10,5	3	2/4	20,00

STOP-TOOLS

Die STOP-Funktion verhindert, dass Gabel oder Löffel in das Gefäß rutschen.

The smart STOP-function prevent forks and spoon not to slip into the vessel.

La función STOP evita que los cubiertos se caigan dentro del recipiente. Antideslizante.

La fonction STOP empêche les couverts de glisser dans le récipient.



Servierlöffel

serving spoon
cuchara de servicio
cuillère de service



Materialdicke 2,5 mm, ergonomischer, rutschfester Griff
ergonomic antislip handle
mango ergonómico antideslizante
manche ergonomique antidérapante

	cm	→ cm	€
00834	10 x 7,5	Griff / handle 17	9,90



Servierlöffel geschlitzt

slotted spoon
cuchara de servicio
cuillère de service



Materialdicke 2,5 mm, ergonomischer, rutschfester Griff
ergonomic antislip handle
mango ergonómico antideslizante
manche ergonomique antidérapante

	cm	→ cm	€
00833	10 x 7,5	Griff / handle 17	9,90



Schöpflöffel

ladle
cucharón
louche



Materialdicke 2,5 mm, ergonomischer, rutschfester Griff
ergonomic antislip handle
mango ergonómico antideslizante
manche ergonomique antidérapante

	Ø cm	→ cm	litr.	€
00832	9	Griff / handle 17	0,08	10,40



Fleischgabel

meat fork
tenedor de carne
fourchette à viande



Materialdicke 2,5 mm, ergonomischer, rutschfester Griff
ergonomic antislip handle
mango ergonómico antideslizante
manche ergonomique antidérapante

	cm	→ cm	€
00831	10,5 x 4	Griff / handle 17	9,90

**Servierlöffel**

serving spoon
cuchara de servicio
cuillère de service



ergonomischer, rutschfester Griff
ergonomic antislip handle
mango ergonómico antideslizante
manche ergonomique antidérapante

	cm	→ cm	€
00662	11 x 7	Griff / handle 25	6,00

**Servierlöffel geschlitzt**

serving spoon
cuchara de servicio
cuillère de service



ergonomischer, rutschfester Griff
ergonomic antislip handle
mango ergonómico antideslizante
manche ergonomique antidérapante

	cm	→ cm	€
00664	11 x 7	Griff / handle 25	6,00

**Wender**

turner
espátula
spatule



ergonomischer, rutschfester Griff
ergonomic antislip handle
mango ergonómico antideslizante
manche ergonomique antidérapante

	cm	→ cm	€
00668	10 x 8	Griff / handle 25	6,60



110 ml

Schöpflöffel

ladle
cucharón
louche



ergonomischer, rutschfester Griff
ergonomic antislip handle
mango ergonómico antideslizante
manche ergonomique antidérapante

	cm	→ cm	ltr.	€
00670	9 x 8	Griff / handle 25	0,11	6,60

**Fleischgabel**

meat fork
tenedor de carne
fourchette à viande



ergonomischer, rutschfester Griff
ergonomic antislip handle
mango ergonómico antideslizante
manche ergonomique antidérapante

	cm	→ cm	€
00666	10 x 3,5	Griff / handle 25	6,00

**Schöpflöffel „PROFI“**ladle
cacillo
louche

	∅ cm	→ cm	ltr.	€
00711	6	Griff / handle 28	0,050	11,40
00712	7	Griff / handle 30	0,080	11,80
00713	8	Griff / handle 32	0,125	12,80
00714	9	Griff / handle 33	0,150	14,60
00715	10	Griff / handle 35	0,250	15,40
00716	11	Griff / handle 36	0,300	16,00

**Schaumlöffel „PROFI“**skimmer
espumadera
écumoire

	∅ cm	→ cm	€
00721	10	Griff / handle 34	12,40
00722	12	Griff / handle 37	13,30
00723	14	Griff / handle 40	14,40

**Wender „PROFI“**turner
espátula
spatule

	cm	→ cm	€
00730	10 x 11,5	Griff / handle 38	14,40

**Servierlöffel „PROFI“**serving spoon
cuchara de servicio
cuillère de service

	cm	→ cm	€	
00671	11 x 7	Griff / handle 29	geschlitzt / slotted	8,60
00672	11 x 7	Griff / handle 29		8,60

**Spaghettilöffel „PROFI“**spaghetti spoon
cuchara de espaguetis
cuillère à spaghettis

	cm	→ cm	€	
00673	10 x 7	Griff / handle 29		9,30

**Salat- / Servierlöffel „BANQUET“**

salad spoon / serving spoon
cuchara para ensalade / cuchara de servicio
cuillère à salade / cuillère de service



	cm	→ cm	€
00588	6,0 x 5	Griff / handle 17	4,80
00590	7,5 x 6	Griff / handle 21	7,00

Salatgabel „BANQUET“

salad fork
tenedor de servicio para ensalada
fourchette de service pour la salade



	cm	→ cm	€
00589	6,0 x 5	Griff / handle 17	4,80
00591	7,5 x 6	Griff / handle 21	7,00

Chafing Dish Löffel „BANQUET“

serving spoon
cuchara para servir
cuiller de service



	cm	→ cm	€
00592	11 x 6,5	Griff / handle 24	8,20
00593	11 x 6,5	Griff / handle 24 geschlitzt / slotted	7,90

Dressinglöffel „BANQUET“

dressing spoon
cuchara de aliño
cuillère à vinaigrette



	cm	→ cm	€
00594	6 x 4	Griff / handle 30	9,90

Schöpflöffel „BANQUET“

ladle
cucharón
louche



	cm	→ cm	€
00595	8,5 x 7,5	Griff / handle 24	12,90

Fleischgabel „BANQUET“

meat fork
tenedor de carne
fourchette à viande



	cm	→ cm	€
00596	8 x 2,5	Griff / handle 13	4,20

Serviergabel „BANQUET“

fork
tenedor de servicio
fourchette de service



	cm	→ cm	€
00597	9 x 4	Griff / handle 21	7,20

Pfannenwender „BANQUET“

turner
espatula
spatule



	cm	→ cm	€
00587	10 x 7,5	Griff / handle 21	7,90

**Servier- / Transportwagen**

serving trolley
carro de servicio
chariot de service



Gestell aus Vierkantröhr 25 x 25 mm, Ablagefläche innen 84 x 44,5 cm, Bodenfläche 90 x 50 cm, auf Unterseite schalldämmend beschichtet, Abstand zwischen den Böden 28 cm / 29 cm, mit 4 Lenkrollen Ø 12,5 cm, alle mit Feststellern, Lieferung demontiert, einfache Montage, Tragfähigkeit 33 kg je Boden

frame rectangular bar 25 x 25 mm, shelf board inside 84 x 44,5 cm, shelf board outside 90 x 50 cm, undersurface coated sound-damping, distance between the boards 28 cm / 29 cm, with 4 swivel wheels Ø 12,5 cm, all with brakes, unassembled, simple assembly, max load 33 kg per shelf

estructura tubo cuadrado 25 x 25 mm, útiles int. por piso 84 x 44,5 cm. ext. al suelo 90 x 50 cm revestimiento para absorber ruidos distancia entre pisos 28 cm / 29 cm, 4 ruedas giratorias 12,5 cm, con frenos, se sirve desmontado, montaje fácil, carga máx. 33 kg por piso

structure en tube carré 25x25 mm, 3 niveaux dimensions utiles 84x44,5 cm, encombrement au sol 90x50 cm, avec revêtement en partie inférieure pour absorber le bruit, distance entre niveaux 28 cm / 29 cm, roues pivotantes 12,5 cm, avec frein, livré démonté, montage aisé, max. 33 kg de charge par niveau

	cm	↑ cm	€
71440	96 x 50	94	172,00

**Servier- / Transportwagen**

service trolley
carro de servicio
chariot de service



mit 3 Borden, Bordmaße ca. 83 x 51 cm, Abstand zwischen den Borden ca. 26 cm, Tragfähigkeit 120 kg, 4 Lenkrollen, davon 2 feststellbar, Lieferung demontiert, einfache Montage

with 3 trays, trays approx. 83 x 51 cm, size between the trays approx. 26 cm, total load capacity 120 kg, 4 wheels with 2 brakes, unassembled, simple assembly

con 3 bandejas inox mate, aprox. 83 x 51 cm, la medida entre bandejas aprox. 26 cm capacidad total 120 kg, 4 ruedas con 2 frenos, construcción robusta, montaje fácil

3 niveaux, approx. 83x51 cm chacun, distance entre niveaux 26 cm, capacité maxi 120 kg au total, 4 roues dont 2 avec frein, construction robuste, montage facile

	cm	↑ cm	€
11979	91 x 59	93	156,00

**Servier- / Transportwagen**

service trolley
carro de servicio
chariot de service



mit 2 Borden, Bordmaße ca. 83 x 51 cm, Abstand zwischen den Borden ca. 56 cm, Tragfähigkeit 80 kg, 4 Lenkrollen, davon 2 feststellbar, Lieferung demontiert, einfache Montage

with 2 trays, trays approx. 83 x 51 cm, size between the trays approx. 56 cm, total load capacity 80 kg, 4 wheels with 2 brakes, unassembled, simple assembly

con 2 bandejas de acero inoxidable mate, aprox. 83 x 51 cm, la medida entre bandejas aprox. 56 cm, capacidad total 80 kg, 4 ruedas, con 2 frenos, construcción robusta, montaje fácil

2 niveaux, approx. 83x51 cm chacun, distance entre niveaux 56 cm, capacité maxi 80 kg au total, 4 roues dont 2 avec frein, construction robuste, montage facile

	cm	↑ cm	€
11977	91 x 59	93	134,00



GN 1/1 Regalwagen

GN 1/1 trolley
carro GN 1/1
GN 1/1 chariot



mit 15 Doppelauflegeschiene, zum Transport von bis zu 30 GN-Tablets GN 1/2 oder 15 GN-Behältern bis GN 1/1 (Längseinschub), bei einem Stapelabstand von 75 mm, mit 4 Lenkrollen, 2 mit Feststellern, Tragfähigkeit 100 kg

15 double bars, for transporting up to 30 trays GN 1/2 or 15 GN-containers up to GN 1/1, size between the trays 75 mm, 4 swivel wheels, 2 equipped with brakes total load capacity 100 kg

15 pares de rieles dobles para el transporte de hasta 30 bandejas o 15 cubetas GN 1/1 (apertura por el lado estrecho) distancia entre las bandejas de 75 mm, 2 ruedas giratorias con frenos, carga máxima 100 kg

15 rails doubles pour maxi 30 plateaux GN 1/2 ou 15 plateaux GN 1/1 (ouverture sur le côté étroit 32,5cm), espace entre plateaux 75 mm, 2 roues pivotantes avec frein, charge maxi 100 kg

	cm	↑ cm	€
71441	55 x 38,5	173,5	254,00



mit beidseitiger Kipp- und Durchschubsicherung



Servier- / Transportwagen

serving trolley
carro de servicio
chariot de service



Aluminiumrahmen, 3 Böden, Abstand zwischen den Böden 31 cm, mit 4 Lenkrollen, alle mit Feststellern, Tragfähigkeit: ca. 80 kg je Boden, 240 kg insgesamt, demontiert, einfache Montage, Lieferung ohne Container und Dekoration

frame aluminium, 3 shelves, distance between shelves 31 cm, 4 swivel wheels, all equipped with brakes, max. load per shelf 80 kg, 240 kg total, demounted, easy to mount, delivery without containers and decoration

marco aluminio, 3 pisos, distancia entre cada piso 31 cm, 4 ruedas giratorias, las 4 con frenos, carga máxima por bandeja 80 kg, 240 kg en total, se sirve desmontado, fácil de montar (se entrega sin contenedores ni decoración)

chassis aluminium, 3 étages, distance entre niveaux 31 cm, 4 roues pivotantes, toutes avec frein, charge maximum 80 kg par niveau, 240 kg au total, livré démonté, montage facile (livré sans récipients ni décoration)

	cm	↑ cm	€
11945	108 x 50	96	114,00



Container

container
contenedor
récipient



zum Einhängen, passend zum Servier- / Transportwagen 11945

to hang up, suitable serving trolley 11945

para colgar, adaptado para el carro ref. 11945

à suspendre, pour chariot de service 11945

	cm	↑ cm	ltr.	€
11946	33 x 23	56,5	42	28,00
11947	33 x 23	17,5	13	14,00

**GN 1/1 Besteckbehälter**

GN 1/1 dispenser GN
GN 1/1 dispensador de cubiertos
GN 1/1 bac à couverts



in Handarbeit geflochten, 4 Mulden, Kunststoff-Geflecht, Drahtgestell, braun-schwarz
wickerwork, 4 compartments, with reinforced chromed wire structure, brown-black
cesta trensada a mano, 4 compartimentos, de plástico, con bastidor cromado reforzado, marrón oscuro
corbeille tressée à main, 4 compartiments, en plastique, cadre acier chromé renforcé, couleur marron foncé

	cm	↑ cm	Farbe / Colour	€
11966	53 x 32,5	9		34,00

**GN 1/1 Besteckbehälter „BUFFET“**

GN 1/1 cutlery dispenser
GN 1/1 dispensador de cubiertos
GN 1/1 bac à couverts



4 Mulden, Kunststoff-Geflecht, Drahtgestell, beige
4 troughs, wickerwork, wire, beige
4 huecos, trabajo de cestería
4 compartiments, plastique tressé, cadre acier chromé renforcé, couleur osier naturel

	cm	↑ cm	Farbe / Colour	€
11965	53 x 32,5	10		24,00

**GN 1/1 Besteckbehälter**

GN 1/1 cutlery tray / box stand
GN 1/1 dispensador de cubiertos
GN 1/1 bac à couverts



	cm	↑ cm	Farbe / Colour	€
11955	53 x 32,5	10		6,00

**GN 1/1 Besteckkasten**

cutlery box GN 1/1
GN 1/1 dispensador de cubiertos
GN 1/1 bac à couverts



	cm	↑ cm	Farbe / Colour	€
11960	53 x 32,5	10		6,60

**Besteckständer „TRIPLE TOWER“**

cutlery basket
cesta para cubiertos
égouttoir à couverts



4-teiliges Set: 1 Gestell + 3 Köcher
4 pcs. set: 1 frame + 3 baskets
set de 4 piezas: 1 estructura + 3 cubiertos
set de 4 éléments: 1 structure + 3 corbeille

	cm	↑ cm	Farbe / Colour	€
11466	18 x 26	43		79,00
11467	18 x 26	43		79,00



Besteckköcher
cutlery basket
cesta para cubiertos
corbeille à couverts



	cm	↑ cm	Farbe / Colour	€
84535	12 x 12	16	White	4,90
84536	12 x 12	16	Black	4,90



Besteckbehälter
cutlery basket
recipiente para cubiertos
récipients pour couverts



4 Löcher inkl. 4 Edelstahl Köcher
4 holes incl. 4 stainless baskets
4 agujeros, incl. 4 cestas de acero
4 places, avec 4 corbeille inox

	cm	↑ cm	Farbe / Colour	€
93321	27 x 27	15	Dark Brown	69,00



Besteckbehälter
cutlery basket
dispensador de cubiertos
présentoir à couverts



matt poliert
satin polished finish
inox mate (sin cubiertos)
inox mat

	cm	↑ cm		€
11994	26,0 x 30 Ø 10	20	4 Löcher inkl. Köcher (Kunststoff) 4 holes incl. dispensers (plastic) 4 agujeros incl. dispensador plástico 4 places, avec 4 récipients (plastique)	62,00
11997	37,5 x 30 Ø 10	20	6 Löcher ohne Köcher 6 holes without dispensers 6 agujeros sin dispensador de plástico 6 places, sans récipients	77,00



Besteckköcher
cutlery basket
cesta para cubiertos
corbeille à couverts



	Ø cm	↑ cm		€
11998	9,7	13,7	Kunststoff weiß / white plastic plástico blanco / plastique blanc	2,50
11999	9,7	13,7	matt poliert / satin polished finish acero inoxidable / inox	7,90

**Besteckbehälter „ELEMENT“**

cutlery bin
recipiente para cubiertos
récipients pour couverts



mit Abflussloch, mit Besteck Logo, Bodeneinlagen aus Silikon zum Schonen der Messerspitzen, möbelschonende Unterseite

with drain hole, with cutlery logo, silicone floor inserts for saving the points of knives, with non-scratching undersurface

con orificio de drenaje, con logotipo de cubertería, soporte de silicona para proteger las puntas de los cuchillos, con base antirrayaduras

avec le trou de drainage, avec le logo de coutellerie, insert de silicone pour protéger les pointes des couteaux, avec base revêtue antirayures

	Ø cm	↑ cm	Logo	€
00018	11	14	fork / knife / spoon	15,00



NEW

11935

11936

11937

Besteckbehälter „ELEMENT“

cutlery bin
recipiente para cubiertos
récipients pour couverts



mit Abflussloch, mit weißem Logo, Bodeneinlage aus Silikon zum Schonen des Bestecks, möbelschonende Unterseite

with drain hole, with white logo, silicone floor inserts for saving the cutlery, with non-scratching undersurface

con orificio de drenaje, con logotipo blanco, base de silicona para proteger la cuberteria, con base anti rayaduras

avec trou de drainage, avec logo blanc, insert de silicone pour protéger la coutellerie, avec revêtement antirayures

	Ø cm	↑ cm	Logo	€
11935	12	14	fork	14,50
11936	12	14	knife	14,50
11937	12	14	spoon	14,50



NEW

Besteckbehälter „ACACIA“

cutlery bin
recipiente para cubiertos
récipients pour couverts



Akazienholz natur

acacia wood nature

madera de acacia natrural

bois d'acacia naturale

	cm	↑ cm	Logo	€
11939	14 x 14	15	fork / knife / spoon	14,00



Besteckbehälter „VINTAGE“

cutlery bin
recipiente para cubiertos
récipients pour couverts

Akazienholz vintage weiß
acacia wood, vintage white
madera de acacia, blanca vintage
bois d'acacia, blanc vintage



	cm	↑ cm	Logo	€
11938	14 x 14	15	fork / knife / spoon	14,00



40130
beige

40007
black

40012
brown

40013
anthrazit

Besteckkorb „ECONOMIC“

cutlery dispenser
dispensador de cubiertos
corbeille à couverts

in Handarbeit geflochten
wickerwork
trensado a mano
tressage à main



	Ø cm	↑ cm	Farbe / Colour	€
40130	12	15		3,40
40007	12	15		3,40
40012	12	15		3,40
40013	12	15		3,40



40131

40009

40010

40011
anthrazit

Besteckkorb „ECONOMIC“

cutlery dispenser
dispensador de cubiertos
corbeille à couverts

in Handarbeit geflochten
wickerwork
trensado a mano
tressage à main



	cm	↑ cm	Farbe / Colour	€
40131	27 x 10	4,5		3,40
40009	27 x 10	4,5		3,40
40010	27 x 10	4,5		3,40
40011	27 x 10	4,5		3,40



Besteckständer

cutlery basket
cesta para cubiertos
égouttoir à couverts



	Ø cm	↑ cm	€
11921	10	10,0	7,40
11922	12	13,5	9,90



Sortierbox „MULTI“

shape sorter
caja surtida
boîte de tri



inklusive 3 herausnehmbare Trennwände, 4 Kammern
including 3 removable divider, 4 chambers
con 3 divisores extraíbles, 4 compartimentos
avec 3 parois de séparation amovibles, 4 compartiments

	cm	↑ cm	litr.	Farbe / Colour	€
84531	31,5 x 17,5	7	2,1	White	19,00
84532	31,5 x 17,5	7	2,1	Black	19,00



Eier-Box

eggs box
caja para huevos
boîte à oeufs



mit luftdichtem Deckel, für 4 Lagen à 30 Eier, Lieferung inkl. 8 Lagen, Größe Lage: 28 x 28 cm
with airtight cover, capacity: 4 trays of 30 eggs, delivery with 8 trays, size of tray: 28 x 28 cm
capacidad para 4 bandejas de 30 huevos, tapa hermética, se entrega con 8 bandejas, formato bandejas 28 x 28 cm, apto para lavavajillas
pour 4 plateaux de 30 oeufs chacun, apte pour 4 plateaux plats, couvercle hermétique, livré avec 8 plateaux, dimension plateau 28x28 cm, lavable en lave-vaisselle

	cm	↑ cm	GN	€
82419	35,4 x 32,5	20	2/3	34,00

10 Lagen / 10 trays / 10 bandejas / 10 plateaux

82420				23,00
-------	--	--	--	-------



Rechteckschalen

container
cubeta
bac



	cm	↑ cm	litr.	€
11941	30 x 21,0	6,5	2	4,00
11942	34 x 23,5	7,0	3	5,20
11943	48 x 33,0	8,0	8	11,00



Wanne
container
cubeta
bac



	cm	↑ cm	ltr.	€
11940	61 x 44	15	25	21,60



Geschirrwanne
container
cubeta para vajilla
bac à vaisselle



	cm	↑ cm		€
11950	55 x 42	14		10,00



Serviertablett „RUTSCHFEST“

tray non-slip
bandeja antideslizante
plateau antiglisse

rutschfeste Oberfläche
non-slip surface
superficie anti-deslizante
surface antidérapante



	cm	↑ cm	GN	Farbe / Colour	€
00502	53 x 32,5	1,5	1/1		21,90
00508	46 x 36,0	2			20,80
00505	53 x 32,5	1,5	1/1		21,90
00503	53 x 37,0	1,5			25,00



Fast Food Tablett

snack tray
bandeja autoservicio y snacks
plateau self-service et snacks



	cm	↑ cm	GN	Farbe / Colour	€
00530	35 x 27,0	2			3,10
00535	41 x 30,5	2			4,10
00540	45 x 35,5	2			5,10
00552	53 x 32,5	2	1/1		6,20
	cm	↑ cm	GN	Farbe / Colour	€
00531	35 x 27,0	2			3,10
00536	41 x 30,5	2			4,10
00541	45 x 35,5	2			5,10
00553	53 x 32,5	2	1/1		6,20
	cm	↑ cm	GN	Farbe / Colour	€
00532	35 x 27,0	2			3,10
00537	41 x 30,5	2			4,10
00542	45 x 35,5	2			5,10
00554	53 x 32,5	2	1/1		6,20
	cm	↑ cm	GN	Farbe / Colour	€
00533	35 x 27,0	2			3,10
00538	41 x 30,5	2			4,10
00543	45 x 35,5	2			5,10
00555	53 x 32,5	2	1/1		6,20



Bar, Café Drinkware



Sektkühler
Shaker
Barmaß
Aschenbecher
Tabletts

cubiteras
cocteleras
medidores jigger
ceniceros
bandejas

champagne bowls
shakers
jiggers
ashtrays
trays

seaux à champagne
shakers
mesures jigger
cendriers
plateaux

**Flaschenkühler „MOSCOW MULE“**

bottle cooler
enfriador de botellas
rafraîchisseur de bouteilles

Edelstahl-Flaschenkühler, Antik-Kupfer-Look
stainless steel cooler, copper antique look
enfriador de acero inoxidable, cobre estilo antiguo
rafraichisseur en acier inox, cuivre style antique



	Ø cm	↑ cm	ltr.		€
93330	20	21	5	copper-antique-hammered	46,00

**Wein- / Sektkühler „TROPHY“**

wine / champagne bowl
cubitera para vino y cava
seau à vin ou champagne

hochglanzpoliert, mit Griffen, Fuß Ø 18,5 cm,
mirror polished finish, with handles, foot Ø 18,5 cm
pulido brillante, 2 asas, pie Ø 18,5 cm
brillant, 2 anses, pied Ø 18,5 cm



	Ø cm	↑ cm	ltr.		€
36092	23	24	5	stainless-steel	29,00
36093	23	24	5	copper-look	34,00

**Wein- / Sektkühler**

wine / champagne bowl
cubitera para vino y cava
seau à vin ou champagne

innen mattiert, außen hochglanz, mit massiven Knopf-Griffen,
extra stabiler ingerollter Rand, schwere Ausführung

outside mirror polished finish, inside satin polished finish,
with solid knob handles, rolled edge, heavy quality

acabado pulido brillante, asas de botón robustas, borde redondeado, alta calidad
brillant, 2 poignées robuste en forme de bouton, bord arrondi, haute qualité



	Ø cm	↑ cm	ltr.		€
36028	21,5 / 16	22	4		22,00

**Wein- / Sektkühler**

wine / champagne bowl
cubitera para vino y cava
seau à vin ou champagne

innen mattiert, außen poliert, mit massiven Griffen, Rand ingerollt

outside mirror polished finish, inside satin polished finish, with massive handles, rolled edge
pulido mate, 2 asas macizas, borde redondeado
finition mate, 2 anses massives, bord rond



	Ø cm	↑ cm	ltr.		€
36025	21 / 15	21	3,5		16,00

**Mini-Eiseimer / Mini-Sektkühler**

ice bucket
cubitera clásica
seau à glaçons classique



	Ø cm	↑ cm	ltr.		€
36003	10,5	10	0,5		8,00
36004	13,0	13	1,0		10,00



hot price

**Wein- / Sektkühler**

wine / champagne bowl
cubitera para vino y cava
seau à vin ou champagne

aussen hochglanzpoliert, innen matt poliert, mit Ring-Griffen

outside mirror polished finish, inside satin polished finish, with ring handles

acabado pulido brillante, interior efecto satinado con 2 asas anillos

extérieur brillant, intérieur satin, avec 2 anneaux

	Ø cm	↑ cm	ltr.	€
36020	20 / 15	19	3	12,00

**Wein- / Sektkühler**

wine / champagne bowl
cubitera para vino y cava
seau à vin ou champagne

matt poliert, Hohlgriffe

satin polished finish, hollow handles

acabado pulido satinado, con asas huecas

finition mate, 2 boutons creux

	Ø cm	↑ cm	ltr.	€
36021	20 / 15	20,5	4	13,50

**Wein- / Sektkühler „HAMMERSCHLAG“**

wine / champagne bowl
cubitera para vino y cava
seau à vin ou champagne

hochglanzpoliert, mit massiven Ring-Griffen, eingerollter Rand

mirror polished finish, with solid ring handles, rolled edge, hammered

acabado pulido brillante, con 2 anillos macizos, borde redondeado, repujado

brillant, 2 anneaux massifs, bord arrondi, surface martelée

	Ø cm	↑ cm	ltr.	€
36026	21 / 17	21,5	4	15,00



hot price

**Wein- / Sektkühler**

wine / champagne bowl
cubitera para vino y cava
seau à vin ou champagne

glasklarer Rand, transparent gefrostet

edge transparent, body transparent frosted

borde transparente, cuerpo transparente efecto glaseado

bord transparent, corps finition mate

	Ø cm	↑ cm	ltr.	€
36066	22 / 14	23	4	9,00

**Wein- / Sektkühler**

wine / champagne bowl
cubitera para vino y cava
seau à vin ou champagne

glasklar, mit Tragegriff

transparent, handle on the side

transparente, con un asa en el lateral

transparent, avec poignée

	cm	↑ cm	ltr.	€
36055	23 x 22	27,5	3	17,00

**Wein- / Sektkühler**

wine / champagne bowl
cubitera para vino y cava
seau à vin ou champagne



mit seitlichen Griffen, transparent
with lateral handles, transparent
con asas laterales
avec poignées latérales

	cm	↑ cm	ltr.	€
36081	20 x 20	20	4,5	17,40

**Ständer für Wein- / Sektkühler**

stand for wine / champagne bowl
pie porta champañera / vino
pied pour seau à champagne / vin



hochglanzpoliert, schwerer standsicherer Fuß, Innendurchmesser der Schale Ø 15 cm
mirror polished finish, heavy foot, inner bowl Ø 15 cm
acabado pulido efecto brillante, bol interior de Ø 15 cm
brillant, intérieur support Ø 15 cm

	Ø cm	↑ cm	€
36068	15 / 28	68	79,00

**Ständer für Wein- / Sektkühler**

stand for wine / champagne bowl
pie porta champañera / vino
pied pour seau à champagne / vin



hochglanzpoliert, schwerer standsicherer Fuß, Innendurchmesser der Schale Ø 17,5 cm
mirror polished finish, heavy foot, inner bowl Ø 17,5 cm
acabado pulido efecto brillante, bol interior de Ø 17,5 cm
brillant, intérieur support Ø 17,5 cm

	Ø cm	↑ cm	€
36069	17,5 / 26,5	73	99,00

**Wein- / Sektkühler no. 36028**

wine / champagne bowl no. 36028
cubitera para vino y cava no. 36028
seau à vin ou champagne no. 36028

**Tischhalterung für Sektkühler**

champagne bucket table holder
soporte champañera universal
porte-seau à champagne



aus 8 mm starkem Stahldraht, passen zu allen lieferbaren Sektkühlern, innen Ø-Ring: 18 cm
8 mm chrome plated wire, suitable for all available champagne buckets
alambre cromado 8 mm, para todas las champañeras
fil chromé 8 mm, pour tous les seaux à champagne

	cm	↑ cm	€
30332	49 x 20	17	11,00



NEW

7 ltr.

Wein- / Sektkühler
wine / champagne bowl
cubitera para vino y cava
seau à vin ou champagne

gehämmerte Oberfläche mit 2 seitlichen Eingriffen
hammered surface with 2 handles on the side
superficie martillada con 2 asas
surface martelée avec 2 poignées

	cm	↑ cm	ltr.	Farbe / Colour	€
36111	30 x 23,5	23	7	copper-look	49,00



NEW

7 ltr.

Wein- / Sektkühler
wine / champagne bowl
cubitera para vino y cava
seau à vin ou champagne

gehämmerte Oberfläche mit 2 seitlichen Eingriffen
hammered surface with 2 handles on the side
superficie martillada con 2 asas
surface martelée avec 2 poignées

	cm	↑ cm	ltr.	Farbe / Colour	€
36112	30 x 23,5	23	7	gunmetal-look	49,00



NEW

11 ltr.

36100

Getränkewanne „TIN“
beverage tub
barreño botellines
bassine à glace

Metall verzinkt, mit Kunststoffeinsatz, mit massiven Ring-Griffen
galvanised metal, with plastic insert, with solid ring handles
metal galvanizado, con inserto de plástico, con 2 anillos macizos
métal galvanisé, avec insert en plastique, 2 anneaux massifs



	Ø cm	↑ cm	ltr.	Farbe / Colour	€
36100	40 x 28	22	11	copper-look	29,00
36101	40 x 28	22	11	black-metal-look	24,00



11 ltr.

36101



mit Kunststoffeinsatz
with plastic insert
con inserto de plástico
avec insert en plastique



71490

Kreidestift zum Beschriften
chalk marker for writing
S. 312

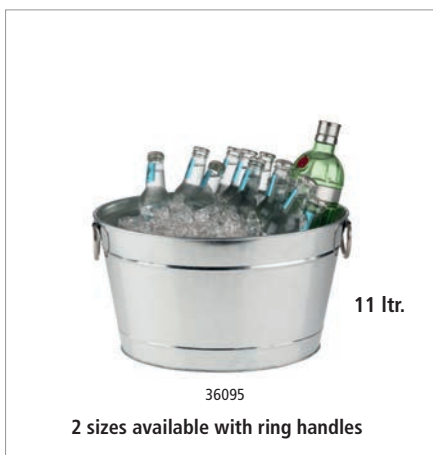

11 ltr.

36095

2 sizes available with ring handles

Getränkewanne „TIN“
beverage tub
barreño botellines
bassine à glace

Metall verzinkt, mit Kunststoffeinsatz, mit massiven Ring-Griffen
galvanised metal, with plastic insert, with solid ring handles
metal galvanizado, con inserto de plástico, con 2 anillos macizos
métal galvanisé, avec insert en plastique, 2 anneaux massifs



	Ø cm	↑ cm	ltr.	€
36095	40 x 28	22	11	24,00
36096	50 x 32	23	18	29,00

**Champagnerkühler**

champagne bowl
cubo champañera
seau à champagne



hochglanzpoliert, Rand matt poliert
mirror polished finish, edge satin polished finish
acabado pulido brillante, borde satinado
brillant, bord mat

	Ø cm	↑ cm	ltr.	€
36046	45 / 21	23	12	39,90

**Champagnerkühler**

champagne bowl
cubo champañera
seau à champagne



hochglanzpoliert, Lieferung ohne Gläser-Ring
mirror polished finish, delivery without holder
acabado efecto brillante, se entrega sin el aro colgador para copas
brillant, livré sans le support à flûtes

	Ø cm	↑ cm	ltr.	€
36045	40,5 / 27,5	22,5	13,5	49,90

**Champagnerkühler**

champagne bowl
cubo champañera
seau à champagne



außen hochglanzpoliert, innen matt poliert, mit vergoldeten Griffen
outside mirror polished finish, inside satin polished finish, with gold plated handles
exterior pulido brillante, interior satinado
extérieur brillant, intérieur satin

	Ø cm	↑ cm	ltr.	€
36047	42 / 27	28	20	79,00

**Flaschenkühler „BRIDGE“**

bottle cooler
enfriador de botellas
rafraîchisseur de bouteilles

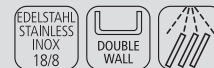

doppelwandig für beste Isolierung, außen poliert, innen mattiert
double wall cooler keeps the temp. for a long time, outs. mirror polished, inside matt finish
champañera inox de doble pared, interior mate, exterior brillante
seau inox double paroi, maintient le froid plus longt., intérieur mat, extérieur poli brillant

	Ø cm	↑ cm	ltr.	€
36077	31	19	10	98,00

**Konferenzkühler „BRIDGE“ no. 13985**

bottle cooler no. 13985
enfriador no. 13985
rafraîchisseur no. 13985

**Champagnerkühler**

champagne bowl
cubo champañera
seau à champagne

hochglanzpoliert, doppelwandig
mirror polished finish, double wall
acabado pulido brillante con doble pared
brillant, double paroi

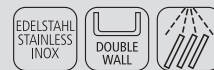

	Ø cm	↑ cm	ltr.	€
36044	44 / 25	24	10,5	96,00

**Flaschenkühler / Getränkeschale**

bottle cooler / bowl
enfriador de botella
rafraîchisseur de bouteille

mit seitlichen Griffen, transparent
with lateral handles, transparent
con asas laterales
avec poignées latérales



	cm	↑ cm	ltr.	€
36082	35,5 x 35,5	20	16	38,00

**Wein- / Sektkühler**

wine / champagne bowl
cubitera para vino y cava
seau à vin ou champagne
mit seitlichen Griffen, transparent

with lateral handles, transparent
con asas laterales
avec poignées latérales



	cm	↑ cm	ltr.	€
36087	32 x 21,5	24,5	7	23,00

**Wein- / Sektkühler**

wine / champagne bowl
cubitera para vino y cava
seau à vin ou champagne

glasklar, für bis zu 6 Flaschen geeignet
transparent, suitable for up to 6 bottles
transparente, para máximo 6 botellas
transparent, maxi 6 bouteilles



	cm	↑ cm	ltr.	€
36057	47 x 28	23	10	36,00

**Wein- / Sektkühler**

wine / champagne bowl
cubitera para vino y cava
seau à vin ou champagne

mit 2 seitlichen Eingriffen
with 2 handles on the side
con 2 asas
avec 2 poignées



	cm	↑ cm	ltr.	€
36048	35 x 27	25,5	6	28,00
36052	27 x 20	21	3	16,00

**Wein- / Sektkühler**

wine / champagne bowl
cubitera para vino y cava
seau à vin ou champagne

mit 2 seitlichen Eingriffen
with 2 handles on the side
con 2 asas
avec 2 poignées



	cm	↑ cm	ltr.	Farbe / Colour	€
36054	35 x 27	25,5	6	■	33,00
36053	27 x 20	21,0	3	■	20,00

**Wein- / Sektkühler**

wine / champagne bowl
cubitera para vino y cava
seau à vin ou champagne

glasklar, für zwei Flaschen
transparent, for two bottles
transparente, para 2 botellas
transparent, pour 2 bouteilles



	cm	↑ cm	ltr.	€
36056	30,5 x 21,5	26	4	19,50

**Flaschenkühler „COPPER“**

bottle cooler
enfriador de botella
rafraîchisseur de bouteille

Hammerschlagoptik, doppelwandig für beste Isolierung, für 0,7 - 1,5 Liter-Flaschen

double wall cooler keeps the temperature for a long time, hammered look, for 0,7 - 1,5 ltr. bottles
doble pared para mantener el frío largo tiempo, botellas de 0,7 - 1,5 ltr.
double paroi pour une meilleure conservation de la température, pour bouteilles de 0,7 à 1,5 l.

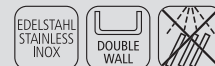

	Ø cm	↑ cm	Farbe / Colour	€
36074	12 / 10	20	■	23,00

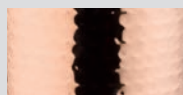

1:1 Oberflächenansicht
1:1 structural view

**Flaschenkühler**

bottle cooler
enfriador de botella
rafraîchisseur de bouteille

matt poliert, doppelwandig für beste Isolierung

satin polished finish, double wall cooler keeps the temperature for a long time
acero inoxidable mate con doble pared para mantener el frío largo tiempo
inox mat, double paroi pour une meilleure conservation de la température

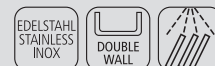

	Ø cm	↑ cm	€
36030	12,0 / 10	20	16,00
36038	12,5 / 10	19	21,00

**Flaschenkühler**

bottle cooler
enfriador de botella
rafraîchisseur de bouteille

transparent, doppelwandig für beste Isolierung, mit Chromrand

transparent, double wall cooler keeps the temperature for a long time, with chrome edge
transpar., doble pared mantiene la temperatura por largo tiempo, borde superior cromado
transparent, bord chromé brillant, double paroi pour maintien en température

	Ø cm	↑ cm	Farbe / Colour	€
36032	12 / 10	23		6,90
36034	12 / 10	23		6,90

**Flaschenkühler „PURE“**

bottle cooler
enfriador de botella
rafraîchisseur de bouteille



doppelwandig für beste Isolierung, glasklar / doublewall, clear / doble pared / double paroi

	Ø cm	↑ cm	€
36063	13,5 / 10,5	23	7,90

**Flaschenkühler „CRYSTAL“**

bottle cooler
enfriador de botella
rafraîchisseur de bouteille



doppelwandig für beste Isolierung, glasklar / doublewall, clear / doble pared / double paroi

	Ø cm	↑ cm	€
36062	13,5 / 10,5	23	7,90

**Flaschenkühler „CLASSIC“**

bottle cooler
enfriador de botella
rafraîchisseur de bouteille



edler Kunststoffmantel in matt-metall Optik, Rand hochglanzpoliert, speziell isolierter Kunststoffeinsatz sorgt für beste Kühlung, für 0,5 - 1,5 Liter-Flaschen, Material: Mylar

noble plastic jacket in satin metal look, mirror polished finish edge, special insulated plastic insert, for 0,5 - 1,5 ltr. bottles, material: mylar

plástico imitación metal aspecto satinado, borde brillante, aislado interior especial para botellas de 0,5 a 1,5 ltr., material: mylar

plastique aspect métal satiné, bord brillant, paroi intérieure spécialement isolante pour bouteilles de 0,5 à 1,5 l., matière: mylar

	Ø cm	↑ cm	€
36036	12,5 / 10	22	14,20

**Flaschenkühler**

bottle cooler
enfriador de botella
rafraîchisseur de bouteille



Rand matt poliert, doppelwandig für beste Isolierung, für 0,7 - 1,5 Liter Flaschen

satin polished finish edge, double wall cooler keeps the temperature for a long time, for 0,7 - 1,5 ltr. bottles

borde pulido satinado, con doble pared para mantener más tiempo la temperatura para botellas de 0,7 a 1,5 l.

bord métallique mat, double paroi pour excellente conservation de la température, pour bouteilles de 0,7 à 1,5 l.

	Ø cm	↑ cm	€
36050	11,5 / 9,5	23	18,90

**Flaschenkühler „ELEMENT BLACK“**

bottle cooler
enfriador de botella
rafraîchisseur de bouteille



Beton, mit möbelschonender Unterseite
concrete, with non-scratching undersurface
hormigón, con base anti rayaduras
béton, avec base revêtement antirayures

	Ø cm	↑ cm	€
36099	12 / 10	19	16,80

**Flaschenkühler „ELEMENT“**

bottle cooler
enfriador de botella
rafraîchisseur de bouteille



Beton, mit möbelschonender Unterseite
concrete, with non-scratching undersurface
el hornigón, con base antirrayaduras
le béton, avec base revêtue antirayures

	Ø cm	↑ cm	€
36090	12 / 10	19	16,80

**Kühlmanschette „WINE“**

cool collar
funda enfriadora
manchette rafraîchissante



für Mineralwasser- und Weinflaschen, Aktivkühler, ohne Eis, nach 5 Minuten gekühlt, Aufbewahrung im Gefrierfach

for soda- and winebottles, active chiller without ice, chilled in 5 minutes, keep in the freezer
para botellas de agua embotellada y vino, enfría sin hielo, en sólo 5 minutos, guardar en el congelador

refroidit en 5 minutes, sans glace, conserver au congélateur, pour l'eau embouteillée et les bouteilles de vin

	cm	↑ cm	Farbe / Colour	€
36083	14 x 2	17,5		9,00

**Kühlmanschette**

cool collar
funda de frío
housse isotherme



für Sekt- / Champagnerflaschen, einfach im Gefrierfach einfrieren, komplette Flasche wird in 5 Min. auf angenehme Trinktemperatur gekühlt, außen reißfestes Stoffgewebe, innen Kunststoff mit Kühlgel gefüllt, unbegrenzt wiederverwendbar

for bottles of champagne, simply to freeze in the freezer, complete bottles will be cooled down in only 5 minutes, tearproof cloth outside, plastic filled with gel inside, unlimited reusable
para botellas de cava o champán simplemente congelándola en el congelador, la botella entera se enfriará en 5 minutos, funda de plástico muy robusta, rellena con un gel congelante reutilizable ilimitadamente

pour bouteilles de vin ou champagne, la housse est préalablement stockée au congélateur, où elle accumule le froid, ensuite elle refroidit une bouteille en quelques minutes, plastique résistant, contient un liquide congelant, à réutiliser de façon illimitée

	Ø cm	↑ cm	€
36075	11	18	6,00

**Pitcher**pitcher
jarra
pichet

	Ø cm	↑ cm	ltr.	€
93105	13	21	1,5	8,40

**Weinflaschenhalter**winebottle-stand
soporte para botella de vino
porte-bouteille

	cm	↑ cm	€
30333	22 x 6	20,5	7,40

**Flaschenträger**bottle rack
porta botellas
porte-bouteilles

für 6 Flaschen, Ring Ø 9,5 cm

for 6 bottles, ring Ø 9,5 cm

para 6 botellas, Ø 9,5 cm

pour 6 bouteilles, Ø 9,5 cm

	cm	↑ cm	€
00630	32 x 21,5	32,5	12,00

**Bierglasträger**beer rack
porta vasos de cerveza
porte verres à bière

für Glasgrößen 0,2 - 0,3 Liter, für 10 Gläser, Ring Ø 6,5 cm

for glasses size 0,2 - 0,3 liter, for 10 glasses, ring Ø 6,5 cm

para vasos tamaño 0,2-0,3 l, para 10 vasos, Ø 9,5 cm

pour verres de 0,2 à 0,3 l, pour 10 verres, Ø 9,5 cm

	cm	↑ cm	€
00632	40 x 16,5	29	18,00

**Gläserchiene**glass rack
rack de copas
rack porte-verres

aus 6 mm verchromten Draht, Wand- und Deckenmontage möglich, bietet Platz für 20 Gläser

6 mm chrome plated wire, can be mounted under a shelf or on the wall, for 20 glasses

alambre cromado de 6 mm, puede instalarse bajo una estantería o en la pared para 20 copas

fil chromé de 6 mm, à installer sous une étagère ou contre un mur, pour 20 verres à pied

	cm	↑ cm	€
93400	45 x 32	6	30,00

CRYSTAL

0,15 - 0,30 - 0,50 ltr.



Trinkbecher „CRYSTAL“

drinking cups

vasos

gobelets



Kristallglas-Optik, vielseitig einsetzbar, robustes, unzerbrechliches Material, ideal in sensiblen Bereichen wie Pool, Spa, Beach und Wellness einzusetzen, BPA-frei
 crystal-glass-look, can be used in versatile ways, a solide and unbreakable material, ideal to be used at pool, spa, beach and wellness areas, bpa-free

look de vidrio, se pueden utilizar de muchas maneras diferentes, material sólido e irrompible, ideal para el uso en áreas como piscina, spa, playa y bienestar, libre de BPA

look de verre de cristal, peuvent être utilisés de différentes façons, matériau robuste et incassable, idéal pour une utilisation dans des zones comme la piscine, le spa, la plage et le bien-être, sans BPA

	Ø cm	↑ cm	ltr.	VE	Farbe / Colour	€/ pc.
10500	7	9,5	0,15	48	—	2,00
10501	8	12,5	0,30	48	—	2,80
10502	9	15,5	0,50	48	—	3,20

	Ø cm	↑ cm	ltr.	VE	Farbe / Colour	€/ pc.
10513	7	9,5	0,15	48	■	2,30
10514	8	12,5	0,30	48	■	3,10
10515	9	15,5	0,50	48	■	3,60



stapelbar
stackable

Trinkglas „BEACH“

drinking glass

vaso

verre



vielseitig einsetzbar, robustes, unzerbrechliches Material, ideal in sensiblen Bereichen wie Pool, Spa, Beach und Wellness einzusetzen, BPA-frei
 can be used in versatile ways, a solide and unbreakable material, ideal to be used at pool, spa, beach and wellness areas, bpa-free

se pueden utilizar de muchas maneras diferentes, material sólido e irrompible, ideal para el uso en áreas como piscina, spa, playa y bienestar, libre de BPA

peuvent être utilisés de différentes façons, matériau robuste et incassable, idéal pour une utilisation dans des zones comme la piscine, le spa, la plage et le bien-être, sans BPA

	Ø cm	↑ cm	ltr.	VE	€/ pc.
10505	8,5	13,5	0,30	48	3,40

MOSCOW MULE



Flaschenkühler „MOSCOW MULE“

bottle cooler
enfriador de botellas
rafraîchisseur de bouteilles



Edelstahl-Flaschenkühler, Antik-Kupfer-Look
stainless steel cooler, copper antique look
enfriador de acero inoxidable, cobre estilo antiguo
rafraîchisseur en acier inox, cuivre style antique

	Ø cm	↑ cm	ltr.	Farbe / Colour	€
93330	20	21	5	copper-antique-hammered	46,00



Becher „MOSCOW MULE“, 2er-Set

barrel copper mug, 2 pcs. set
taza, set de 2
gobelet, set de 2



Edelstahlbecher, Antik-Kupfer-Look
stainless steel cup, copper antique look
taza de acero inoxidable, cobre estilo antiguo
gobelet en acier inox, cuivre style antique

	Ø cm	↑ cm	ltr.	Farbe / Colour	€/Set
93367	9	10	0,5	copper-antique-hammered	22,00

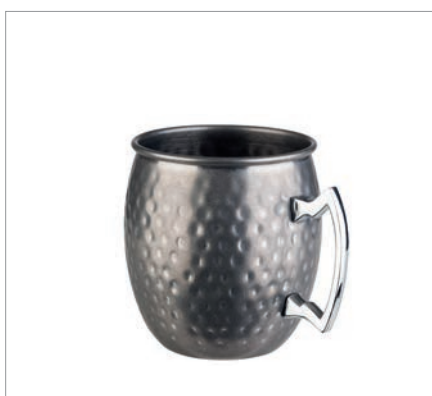

Becher „MOSCOW MULE“

barrel mug
taza
gobelet



Edelstahlbecher, Antik-Edelstahl-Look
stainless steel cup, stainless steel antique look
taza de acero inoxidable, acero estilo antiguo
gobelet en acier inox, acier style antique

	Ø cm	↑ cm	ltr.	Farbe / Colour	€
93346	9	10	0,5	stainless-antique-hammered	11,00

**Becher „MOSCOW MULE“**

barrel mug
taza
gobelet



Edelstahlbecher, Antik-Edelstahl-Look
stainless steel cup, stainless antique look
taza de acero inoxidable, acero estilo antiguo
gobelet en acier inox, acier style antique

	Ø cm	↑ cm	ltr.	Farbe / Colour	€
93345	9	9	0,45	 stainless-antique	11,00

**Becher „MOSCOW MULE“**

barrel copper mug
taza
gobelet



Edelstahlbecher, Antik-Kupfer-Look
stainless steel cup, copper antique look
taza de acero inoxidable, cobre estilo antiguo
gobelet en acier inox, cuivre style antique

	Ø cm	↑ cm	ltr.	Farbe / Colour	€
93322	9	9	0,45	 copper-antique	11,00

**Becher „MOSCOW MULE“**

barrel copper mug
taza
gobelet



Edelstahlbecher, Kupfer-Look, glänzend
stainless steel cup, copper look, highshine
taza de acero inoxidable, cobre, brillante
gobelet en acier inox, cuivre, brillant

	Ø cm	↑ cm	ltr.	Farbe / Colour	€
93310	9	9	0,45	 copper	11,00

**Becher „MOSCOW MULE“**

barrel copper mug
taza
gobelet



Edelstahlbecher, Kupfer-Look, glänzend
stainless steel cup, copper look, highshine
taza de acero inoxidable, cobre, brillante
gobelet en acier inox, cuivre, brillant

	Ø cm	↑ cm	ltr.	Farbe / Colour	€
93311	9	10	0,50	 copper-hammered	11,00

**Becher „MOSCOW MULE“**

barrel copper mug
taza
gobelet



Edelstahlbecher, Antik-Kupfer-Look
stainless steel cup, copper look
taza de acero inoxidable, cobre estilo antiguo
gobelet en acier inox, cuivre style antique

	Ø cm	↑ cm	ltr.	Farbe / Colour	€
93323	9	10	0,50	 copper-antique-hammered	11,00

**Becher „MOSCOW MULE“**

barrel mug
taza
gobelet



Edelstahlbecher, Antik-Edelstahl-Look
stainless steel cup, stainless antique look
taza de acero inoxidable, acero estilo antiguo
gobelet en acier inox, acier style antique

	Ø cm	↑ cm	ltr.	Farbe / Colour		€
93333	9,5	10	0,50		stainless-antique	11,00

**Becher „MOSCOW MULE“**

barrel copper mug
taza
gobelet



Edelstahlbecher, Antik-Kupfer-Look
stainless steel cup, copper antique look
taza de acero inoxidable, cobre estilo antiguo
gobelet en acier inox, cuivre style antique

	Ø cm	↑ cm	ltr.	Farbe / Colour		€
93331	9,5	10	0,50		copper-antique	11,00

**Becher „MOSCOW MULE“**

barrel copper mug
taza
gobelet



Edelstahlbecher, Kupfer-Look, glänzend
stainless steel cup, copper look, glossy
taza de acero inoxidable, cobre, brillante
gobelet en acier inox, cuivre, brillant

	Ø cm	↑ cm	ltr.	Farbe / Colour		€
93332	9,5	10	0,50		copper	11,00

**Becher „MINI SHOT“, 4er-Set**

barrel mug 4 pcs. set
taza, set de 4
gobelet, set de 4



	Ø cm	↑ cm	ltr.	Farbe / Colour		€/Set
93342	4,5	4,5	0,05		copper-antique	19,90
93343	4,5	4,5	0,05		copper	19,90
93344	4,5	4,5	0,05		stainless-antique	19,90

**Becher „COCKTAIL MUG“**

barrel
taza
gobelet



	Ø cm	↑ cm	ltr.	Farbe / Colour		€
93370	8,5	14	0,5		stainless	14,90

**Becher „COOL“**barrel mug
taza
gobeletEDELSTAHL
STAINLESS
INOX
18/8**Edelstahlbecher, Kupfer-Look, glänzend**
stainless steel cup, copper look, glossy
taza de acero inoxidable, estilo cobre, brillante
gobelet en acier inox, aspect cuivre, brillant

	Ø cm	↑ cm	ltr.	Farbe / Colour		€
93371	7,5	10,5	0,35		copper-look	9,00

**Becher „COOL“**barrel mug
taza
gobeletEDELSTAHL
STAINLESS
INOX
18/8**Edelstahlbecher, Gunmetal-Look, glänzend**
stainless steel cup, gunmetal look, glossy
taza de acero inoxidable, estilo gunmetal, brillante
gobelet en acier inox, aspect gunmetal, brillant

	Ø cm	↑ cm	ltr.	Farbe / Colour		€
93372	7,5	10,5	0,35		gunmetal-look	9,00

**Becher „COOL“**barrel mug
taza
gobeletEDELSTAHL
STAINLESS
INOX
18/8**Edelstahlbecher, Antik-Edelstahl-Look**
stainless steel cup, stainless antique look
taza de acero inoxidable, acero estilo antiguo
gobelet en acier inox, acier style antique

	Ø cm	↑ cm	ltr.	Farbe / Colour		€
93373	7,5	10,5	0,35		stainless-antique	9,00

**Becher „COOL“**barrel mug
taza
gobeletEDELSTAHL
STAINLESS
INOX
18/8**Edelstahlbecher, Regenbogen-Look**
stainless steel cup, rainbow look
taza de acero inoxidable, estilo arco iris
gobelet en acier inox, look arc-en-ciel

	Ø cm	↑ cm	ltr.	Farbe / Colour		€
93374	7,5	10,5	0,35		rainbow-look	9,00

**Becher „BEER MUG“**barrel mug
taza
gobeletEDELSTAHL
STAINLESS
INOX**Bierkrug, Antik-Look / beer mug, antique look / jarra de cerveza, estilo antiguo / chope, style antique**

	Ø cm	↑ cm	ltr.	Farbe / Colour		€
93364	8,5	13	0,50		copper-antique	14,00
93365	8,5	13	0,50		stainless-antique	14,00



Becher „PINEAPPLE“

barrel mug
taza
gobelet



Glasbecher mit Edelstahl Deckel
glass cup with stainless steel lid
taza de cristal con tapa en acero inoxidable
gobelet en verre avec couvercle en acier inox

	Ø cm	↑ cm	ltr.	€
93375	8,5	17,5	0,35	17,00



Becher „PINEAPPLE“

barrel mug
taza
gobelet



Edelstahlbecher, Kupfer-Look
stainless steel cup, copper look
taza de acero inoxidable, cobre
gobelet en acier inox, cuivre

	Ø cm	↑ cm	ltr.	Farbe / Colour	€
93334	9	19	0,5	copper-look	21,00



Becher „PINEAPPLE“

barrel mug
taza
gobelet



Edelstahlbecher, Gold-Look
stainless steel cup, gold look
taza de acero inoxidable, dorada
gobelet en acier inox, doré

	Ø cm	↑ cm	ltr.	Farbe / Colour	€
93335	9	19	0,5	gold-look	21,00



Becher „MINI SHOT“ 4er-Set

barrel mug, 4 pcs. set
taza, set de 4
gobelet, set de 4



	Ø cm	↑ cm	ltr.	Farbe / Colour	€/Set
93339	4,5	5,5	0,06	copper-antique-hammered	19,90
93340	4,5	5,5	0,06	copper-hammered	19,90
93341	4,5	5,5	0,06	stainless-antique-hammered	19,90



Becher „JULEP MUG“
barrel mug
taza
gobelet



	Ø cm	↑ cm	ltr.	Farbe / Colour	€
93336	8	11,5	0,40	copper-antique-hammered	12,00
93337	8	11,5	0,40	copper hammered	12,00
93338	8	11,5	0,40	stainless-antique-hammered	12,00



Becher „JULEP MUG“
barrel mug
taza
gobelet



	Ø cm	↑ cm	ltr.	Farbe / Colour	€
93327	8,5	10	0,35	copper-antique	12,00
93328	8,5	10	0,35	copper	12,00
93329	8,5	10	0,35	stainless	12,00



Shaker „CLASSIC“

shaker
coctelera
shaker



Edelstahlbecher, hochglanzpoliert
stainless steel cup, mirror polished finish
taza de acero, acabado pulido brillante
gobelet en acier, brillant

	Ø cm	↑ cm	ltr.	€
36010	8,5	20	0,5	13,50
36011	9,0	23	0,7	17,50



Shaker „CLASSIC“

shaker
coctelera
shaker



Edelstahlbecher, Kupfer-Look, glänzend
stainless steel cup, copper look, highshine
taza de acero inoxidable, cobre, brillante
gobelet en acier inox, cuivre, brillant

	Ø cm	↑ cm	ltr.	Farbe / Colour	€
93211	8,5	20	0,5	copper	15,50
93212	9,0	23	0,7	copper	19,90



Shaker „CLASSIC“

shaker
coctelera
shaker



Edelstahlbecher
stainless steel cup
taza de acero inoxidable
gobelet en acier inox

	Ø cm	↑ cm	ltr.	Farbe / Colour	€
93366	9,0	23	0,7	stainless-antique	19,90
93326	9,0	23	0,7	copper-antique	19,90



Parisian Shaker

shaker
coctelera
shaker



Edelstahlbecher, mattiert
stainless steel cup, satin polished finish
taza de acero, acabado efecto satinado
gobelet en acier, fini mat effet satin

	Ø cm	↑ cm	ltr.	€
93179	9,5	24	0,7	16,00

**Boston Shaker**

boston shaker
coctelera boston
shaker boston



2-teilig: Becher, 700 ml + Glas, 400 ml

2 pcs. set: beaker, 700 ml + glass, 400 ml

set de 2 piezas: vaso coctelero, 700 ml+ vaso vidrio 400 ml

2 pièces: bol mélangeur, 700 ml + bol en verre 400 ml

	Ø cm	↑ cm	ltr.	Farbe / Colour		€
93140	9	30	0,70 / 0,40		stainless-steel	13,00
93350	9	30	0,70 / 0,40		stainless-antique	14,00

	Ø cm	↑ cm	ltr.	Farbe / Colour		€
93325	9	30	0,70 / 0,40		copper-antique	14,00
93201	9	30	0,70 / 0,40		copper	14,00

Ersatzglas / spare glass / vaso de recambio / verre de rechange

	Ø cm	↑ cm	ltr.		€
93138	8,5	14,5	0,4		8,40

**Boston Shaker**

boston shaker
coctelera boston
shaker boston



2-teilig: Becher, 700 ml, gummiert, rutschfest + Glas, 400 ml

2 pcs. set: beaker, 700 ml, rubberized, anti-slip + glass, 400 ml

conjunto de 2 piezas: vaso coctelero con goma exterior 700 ml + vaso de vidrio 400 ml

2 pièces: bol mélangeur inox extérieur plastifié couleur 700 ml + bol en verre 400 ml

	Ø cm	↑ cm	ltr.	Farbe / Colour		€
93139	9	30	0,7			13,60

Ersatzglas / spare glass / vaso de recambio / verre de rechange

	Ø cm	↑ cm	ltr.		€
93138	8,5	14,5	0,4		8,40



Barmaß
jigger
medidor jigger
measure double jigger



	Ø cm	↑ cm	cl.	Farbe / Colour	€
93351	4,5	9	2 / 4	stainless-steel-polished	7,00



Barmaß
jigger
medidor jigger
measure double jigger



	Ø cm	↑ cm	cl.	Farbe / Colour	€
93354	4,5	9	2 / 4	stainless-antique	8,00



Barmaß
jigger
medidor jigger
measure double jigger



	Ø cm	↑ cm	cl.	Farbe / Colour	€
93353	4,5	9	2 / 4	copper	10,00



Barmaß
jigger
medidor jigger
measure double jigger



	Ø cm	↑ cm	cl.	Farbe / Colour	€
93352	4,5	9	2 / 4	copper-antique	10,00



Barmaß
jigger
medidor
measure double jigger



	Ø cm	↑ cm	cl.	Farbe / Colour	€
93164	4,5	9	2,5 / 5	stainless-steel-polished	8,00



Barmaß
jigger
medidor jigger
measure double jigger



	Ø cm	↑ cm	cl.	Farbe / Colour	€
93355	4,0	11	1,5 / 2,5 / 3,5 / 5	stainless-antique	9,00



Barmaß
jigger
medidor jigger
measure double jigger



	Ø cm	↑ cm	cl.	Farbe / Colour	€
93324	4	11	2,5 / 5	copper-antique	12,00



Barmaß
jigger
medidor jigger
measure double jigger



	Ø cm	↑ cm	cl.	Farbe / Colour	€
93165	4	11	2,5 / 5	copper	12,00



Barmaß
jigger
medidor jigger
measure double jigger



hochglanzpoliert, schnelles und genaues Abmessen von Spirituosen
mirror polished finish, quick and exact measuring of spirits
pulido brillante, medida rápida y exacta de licores
poli miroir, mesure exact et rapide des spiritueux

	Ø cm	↑ cm	cl	€
93116	6 / 5	6	2 / 4	4,20



Barmaß
jigger
medidor jigger
measure double jigger



	Ø cm	↑ cm	cl	€
93120	4,5 / 3,5	7,0	2 / 4	4,60



Barmaß
jigger
medidor jigger
measure double jigger



	Ø cm	↑ cm	cl	€
93121	4,0 / 3,5	8,5	2 / 4	5,00
93112	4,5 / 4,0	8,5	2,5 / 5	5,40



Barmaß
jigger
medidor jigger
measure double jigger



hochglanzpoliert, schnelles und genaues Abmessen von Spirituosen
mirror polished finish, quick and exact measuring of spirits
pulido brillante, medida rápida y exacta de licores
poli miroir, mesure exact et rapide des spiritueux

	Ø cm	↑ cm	cl.	€
93357	3,5	7,5	3 / 5	5,00



Barmaß
jigger
medidor jigger
measure double jigger



hochglanzpoliert, schnelles und genaues Abmessen von Spirituosen
mirror polished finish, quick and exact measuring of spirits
pulido brillante, medida rápida y exacta de licores
poli miroir, mesure exact et rapide des spiritueux

	Ø cm	↑ cm	cl.	€
93356	5	9	1 / 1,5 / 2 / 3 / 4 / 6	12,00

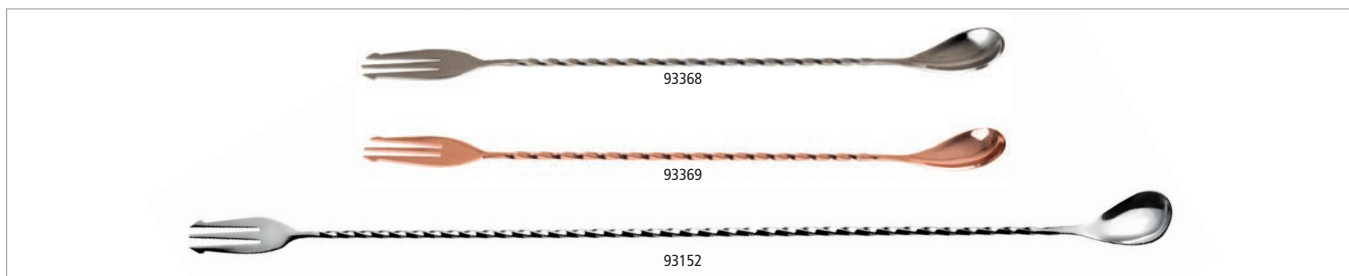
**Barlöffel / -gabel**

bar spoon

cucharilla de cóctel trident

cuillère de bar trident

EDELSTAHL
STAINLESS
INOX

	→ cm	Farbe / Colour		€
93368	30		stainless steel	6,00
93369	30		copper	9,00
93152	50		stainless steel	7,20

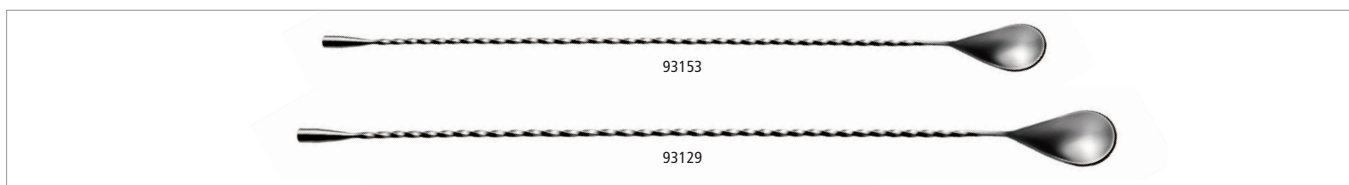
**Barlöffel**

bar spoon

cucharilla de cóctel

cuillère à cocktail

EDELSTAHL
STAINLESS
INOX

	→ cm		€
93153	40		5,40
93129	44		8,80

**Barlöffel**

bar spoon

cucharilla de cóctel

cuillère à cocktail

EDELSTAHL
STAINLESS
INOX

	→ cm		€
93134	27		5,20

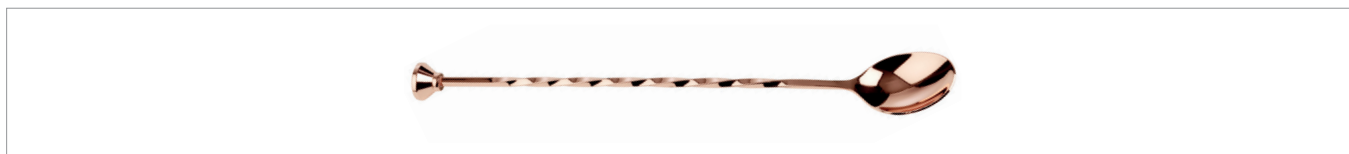
**Barlöffel**

bar spoon

cucharilla de cóctel

cuillère à cocktail

EDELSTAHL
STAINLESS
INOX

	→ cm	Farbe / Colour		€
93034	27		copper	8,00



Barsieb
bar strainer
colador de cóctel
tamis cocktail



hochglanzpoliert, Spiralfeder hält Eiswürfel beim Abseihen zurück, Feder kann zur Reinigung entnommen werden, passend für alle Gläser und Shaker
mirror polished finish, coil spring keeps ice cubes in shaker, spring can be taken off for cleaning, suitable for all glasses and shakers
con muelle para mantener los cubitos en la coctelera, el muelle se desmonta para limpiar, se adapta a todos los tipos de vasos y cocteleras
brillant, avec ressort pour garder les glaçons dans le shaker, ressort démontable pour lavage, s'adapte à tous types de verres mélangeurs et shakers

	∅ cm	→ cm	→ ∅ cm	€
93300	8	Griff / handle 6	mit Auflage-Örchen 12	5,00



Julep Barsieb „PRO“
julep strainer
colador de cóctel
tamis cocktail



hochglanzpoliert
mirror polished finish
acabado pulido brillante
fini poli brillant

	∅ cm	→ cm	€
93313	7,5	Griff / handle 9	9,00



Barsieb
bar strainer
colador de cóctel
tamis cocktail



Spiralfeder hält Eiswürfel beim Abseihen zurück, Feder kann zur Reinigung entnommen werden, passend für alle Gläser und Shaker
coil spring keeps ice cubes in shaker, spring can be taken off for cleaning, suitable for all glasses and shakers
con muelle para mantener los cubitos en la coctelera, el muelle se desmonta para limpiar, se adapta a todos los tipos de vasos y cocteleras
avec ressort pour garder les glaçons dans le shaker, ressort démontable pour lavage, s'adapte à tous types de verres mélangeurs et shakers

	∅ cm	→ cm	Farbe / Colour	€
93347	9	Griff / handle 9	copper-antique	12,00
93348	9	Griff / handle 9	copper	12,00
93349	9	Griff / handle 9	stainless-antique	12,00
93312	9	Griff / handle 9	stainless	10,50



Einhandgebrauch
single-handed use



Stößel
muddler
mortero
pilon muddler



zum Auspressen von Früchten und Zerstoßen von Würfelzucker

to press fruits or pound lump sugar

para exprimir frutas y machacar azucarillos

pour presser les fruits ou le sucre en morceaux

	Ø cm	→ cm	€
93188	4	28	11,00



Stößel
muddler
mortero
pilon muddler



mit griffigem Ende, zum Auspressen von Früchten und Zerstoßen von Würfelzucker

with handy end, to press fruits or pound lump sugar

acabado relieve para prensar frutas o azucar

avec relief grillagé pour presser les fruits ou le sucre en morceaux

	Ø cm	→ cm	Farbe / Colour	€
93180	2,5	21		3,50



Stößel
muddler
mortero
pilon muddler



mit griffigem Ende, zum Auspressen von Früchten und Zerstoßen von Würfelzucker

with handy end, to press fruits or pound lump sugar

con un acabado en relieve para exprimir frutas y machacar azucarillos

avec relief grillagé pour presser les fruits ou le sucre en morceaux

	Ø cm	→ cm	Farbe / Colour	€
93358	3,5	20,5		6,90
93360	3,5	20,5		9,00
93361	3,5	20,5		9,00



Stößel
muddler
mortero
pilon muddler



grober Stößel, zum Auspressen von Früchten und Zerstoßen von Würfelzucker

coarse notched, to press fruits or pound lump sugar

mortero grueso con muescas para exprimir frutas y machacar azucarillos

muddler grand format avec bout relief étoilé pour presser les fruits ou le sucre en morceaux

	Ø cm	→ cm	Farbe / Colour	€
93181	2,5	21		3,50
93182	4	24		7,00





Barsieb
bar strainer
colador de cóctel
tamis cocktail



	Ø cm	→ cm	€
93318	8,5	11,5	3,90



Schneidebrett „BAR“
cutting board
table de corte
planche à découper



HDPE, mit Safrinne, mit Antirutsch-Füßchen
HDPE, with juice groove and non-slip feet
HDPE, con ranura para líquidos y pies antideslizantes
HDPE, avec rigole et pieds antidérapants

	cm	↑ cm	€
93306	30 x 20	2	24,00
93307	50 x 30	2	32,00



Zitruspresse
citrus squeezer
exprimidor cítricos
presse-citron



hochglanzpoliert, 2-teilig
mirror polished finish, 2 pcs.
pulido brillante, 2 piezas
brillant, 2 pièces

	Ø cm	↑ cm	ltr.	€
71431	12 / 17	10,5	0,35	12,90



Cocktailmesser „ORANGE“
bar knife
cuchillo para cóctel
couteau cocktail



mit 2 Zinken zum Aufspießen von Zitrusseiben
with 2 prongs to pick up slices of lemon
con 2 dientes para pinchar las rodajas de limón, etc.
avec 2 dents pour les rondelles de citron et autres décorations

	→ cm	€
88846	21	3,80



Dekoriermesser „ORANGE“
decorating knife „canalé“
cuchillo acanalador
couteau cannelé



gezahnte Klinge aus geschärftem Edeltahl
serrated sharpened blade, stainless steel
hoja de sierra afilada, acero inoxidable
lame inox microdentée

	→ cm	€
88843	19	4,90



2 Pressringe für Zitrone und Limette

Limetten- / Zitronenpresselime- / lemonpress
exprimidor de limón / lima
presse citron

	cm	↑ cm	€
93214	21 x 7	5	13,00

**Limettenpresse**lime press
prensa de limón
presse citron

	cm	↑ cm	€
93189	21 x 7	5	10,00

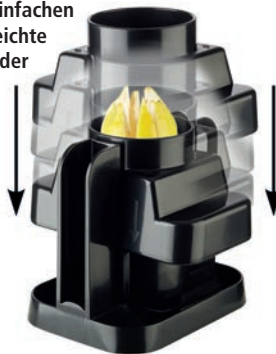

Durch einfachen
Druck leichte
Teilung der
Zitrus!

**Zitrusteiler**citrus wedge
cortador de cítricos
coupe-agrumes

mit Antirutsch-Füßchen, 2-teilig, Griffelement zur sicheren Bedienung mit innenliegendem Schneidmesser, teilt Zitrusfrüchte in Achtel, leicht unter fließendem Wasser zu reinigen

with non-slip feet, 2 pieces, handle for safe use and with internal cutting knife, cut citrus fruits in eight pieces, easy to clean with water
con pies antideslizantes, 2 piezas, asas para un uso seguro y con cuchillas internas, divide los cítricos en ocho partes, fácil de limpiar con agua
pieds antiglisses, 2 pièces, anses pour une usage sûr avec des lames internes, divise les agrumes en huit pièces, facile à nettoyer avec de l'eau

	cm	↑ cm	€
93317	20 x 15	19	60,00

**Eiseimer-Set mit Eiszange**

ice bucket set with tong
cubitera clásica con pinza
seau à glaçons classique avec pince



mit Abtropfgitter, isolierter Kunststoffeinsatz, Zange lässt sich im Deckel verstauen,
für max. 50 Eiswürfel, hält die Eiswürfel bis zu 5 Stunden in ihrer Form

with drainer, insulated plastic insert, tongs can be stored in the lid,
for max. 50 ice cubes, keeps the ice cubes in shape for up to 5 hours

con escurridor, inserto de plástico aislado, la pinza se puede guardar en la tapa, para un
máximo de 50 cubitos de hielo, mantiene los cubitos de hielo en forma hasta 5 horas
avec égouttoir, insert en plastique isolé, la pince peut être rangée dans le couvercle, pour
max. 50 glaçons, maintient les glaçons dans leur forme jusqu'à 5 heures

	Ø cm	↑ cm	ltr.	€
36015	14	22	1,3	24,00

**Eiseimer-Set mit Eiszange**

ice bucket set with tong
cubitera clásica con pinza
seau à glaçons classique avec pince

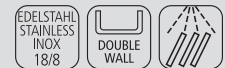

für max. 45 Eiswürfel, hält die Eiswürfel bis zu 5 Stunden in ihrer Form

max. 45 ice cubes, keeps the ice cubes in shape for up to 5 hours

para un máximo de 45 cubitos de hielo, mantiene los cubitos de hielo en forma hasta 5 horas
pour max. 45 glaçons, maintient les glaçons dans leur forme jusqu'à 5 heures

	Ø cm	↑ cm	ltr.	€
36013	12	14	1	29,00

**Eiseimer-Set mit Eiszange**

ice bucket set with tong
cubitera clásica con pinza
seau à glaçons classique avec pince



isolierter Kunststoffeinsatz, hält die Eiswürfel bis zu 5 Stunden in ihrer Form

insulated plastic insert, keeps the ice cubes in shape for up to 5 hours

inserto de plástico aislado, mantiene los cubitos de hielo en forma hasta 5 horas

insert en plastique isolé, maintient les glaçons dans leur forme jusqu'à 5 heures

	Ø cm	↑ cm	ltr.	€
36027	15	15	1,5	16,90
36029	20	18	3	23,00

**Eiseimer-Set mit Eiszange**

ice bucket set with tong
cubitera clásica con pinza
seau à glaçons classique avec pince



edler Kunststoffmantel in matter Optik, Rand hochglanzpoliert, isolierter
Kunststoffeinsatz, hält die Eiswürfel bis zu 5 Stunden in ihrer Form

noble plastic coat in satin metal look, with mirror polished edge, insulated plastic insert,
keeps the ice cubes in shape for up to 5 hours

capa de plástico elegante con óptica de metal mate, borde pulido de alto brillo, inserto de
plástico aislado, mantiene los cubitos de hielo en forma hasta 5 horas

manteau en plastique élégant en optique métal mat, bord poli brillant, insert en plastique
isolé, maintient les glaçons dans leur forme jusqu'à 5 heures

	Ø cm	↑ cm	ltr.	€
36022	15	15	1,5	20,00
36024	20	18	3	23,50



Kühlbox „FROSTY“

bottle cooler
enfriador de botellas
rafraichisseur de bouteilles

mit herausnehmbarem Einsatz für 4 Flaschen

with removable insert for 4 bottles
con inserto extraíble para 4 botellas
avec insert amovible pour 4 bouteilles



Abb. ohne Einsatz
illustration without insert

	cm	↑ cm	ltr.	Ø holes cm	€
93230	27 x 27	15	7,5	11	32,00



Eisbox

icebox
cubitera
seau à glaçons

herausnehmbarer Innenbehälter dient als Tropfeinsatz, für max. 150 Eiswürfel, hält bis zu 5 Stunden die Eiswürfel in ihrer Form

removable inner container serves as drainer, for max. 150 ice cubes, keeps the ice cubes in shape for up to 5 hours

contenedor interior extraíble sirve como inserto de goteo, para un máximo de 150 cubitos de hielo, mantiene los cubitos de hielo en forma hasta 5 horas

réceptier intérieur amovible sert d'égouttoir, pour max. 150 glaçons, maintient les glaçons dans leur forme jusqu'à 5 heures



	cm	↑ cm	ltr.		€
93200	20 x 20	17	3,4	max. 150 ice cubes	28,00
93220	27 x 27	15	5	max. 300 ice cubes	41,00



Eisbox

icebox
cubitera
seau à glaçons

herausnehmbarer Innenbehälter dient als Tropfeinsatz, für max. 150 Eiswürfel, hält die Eiswürfel bis zu 5 Stunden in ihrer Form

removable inner container serves as drainer, for max. 150 ice cubes, ice bucket keeps the ice cubes in shape for up to 5 hours

contenedor interior extraíble sirve como inserto de goteo, para un máximo de 150 cubitos de hielo, mantiene los cubitos de hielo en forma hasta 5 horas

réceptier intérieur amovible sert d'égouttoir, pour max. 150 glaçons, maintient les glaçons dans leur forme jusqu'à 5 heures



	Ø cm	↑ cm	ltr.		€
36033	18,5	20	3	max. 150 ice cubes	38,00



Eisbox

icebox
cubitera
seau à glaçons

herausnehmbarer Innenbehälter dient als Tropfeinsatz, für max. 300 Eiswürfel, hält bis zu 5 Stunden die Eiswürfel in ihrer Form

removable inner container serves as drainer, for max. 300 ice cubes, keeps the ice cubes in shape for up to 5 hours

contenedor interior extraíble sirve como inserto de goteo, para un máximo de 300 cubitos de hielo, mantiene los cubitos de hielo en forma hasta 5 horas

réceptier intérieur amovible sert d'égouttoir, pour max. 300 glaçons, maintient les glaçons dans leur forme jusqu'à 5 heures



	Ø cm	↑ cm	ltr.		€
36037	27	20	6	max. 300 ice cubes	49,00



Eisschaufel
ice scoop
pala de hielo
pelle à glaçons



	cm	→ cm	ltr.	€
93192	10 x 6	29	0,7	7,80



Eisschaufel
ice scoop
pala de hielo
pelle à glaçons



gelocht, ideal zum Befüllen von schlanken Gläsern
perforated, ideal to fill narrow glasses
perforada, ideal para llenar vasos estrechos
perforée, idéale pour verser les glaçons dans des verres étroits

	Ø cm	→ cm	€
93191	5	19	6,50



Glasumrander
glass rimmer
ribeteador de vasos
bordeur à verres „rimmer“



Schwamm für Limettensaft, 2 Fächer für Zucker und Salz
with sponge for lime juice, 2 cases for sugar and salt
con esponja para zumo de lima, 2 compartimentos para azucar y sal
avec éponge et 2 compartiments pour sucre et sel

	cm	Farbe / Colour	€
93175	20 x 7,5	■	9,00



Eis-Kugel-Former
ice ball former
molde de cubitos de hielo esféricos
moule à glaçons en boules



2 tlg., 3 Kugeln à 100 ml, einfach mit Wasser füllen und gefrieren lassen
3 bowls à 100 ml, simply fill with water and allow to freeze
3 bolas de 100 ml, simplemente llenar con agua y dejar congelar
3 boules à 100 ml, simplement remplir avec de l'eau et mettre à congeler

	cm	↑ cm	€
12990	23,5 x 8,5	6,5	9,90



Eiszerkleinerer
Ice crusher
picadora de hielo
broyeur à glaçons



glasklar, mit Edelstahl-Messer
clear, stainless steel cutters
cuchillas de acero inoxidable
couteaux inox

	cm	↑ cm	€
36017	12 x 12	24	15,00

**Pinzettenzange**

fine tong / tweezer
pinza de emplatat
pince à dresser



hochglanzpoliert, geriffelte Grifffläche, schwere Qualität
mirror polished finish, ribbed handle, heavy gauge
acabado brillante, mango cómodo ranurado, alta calidad
brillant, manche rainuré antiglisse, qualité extra

→ cm

€

75820

16

6,00

**Pinzettenzange**

fine tong / tweezer
pinza de emplatat
pince à dresser



hochglanzpoliert, geriffelte Grifffläche, schwere Qualität
mirror polished finish, ribbed handle, heavy gauge
acabado brillante, mango cómodo ranurado, alta calidad
brillant, manche rainuré antiglisse, qualité extra

→ cm

€

75821

30

9,00

**Eiszange**

ice cube tong
pinza para cubitos de hielo
pince à glaçons



hochglanzpoliert, fugenlos
mirror polished finish, seamless
pulido acabado brillante, de una sola pieza
brillant, d'une seule pièce

cm

→ cm

€

75805

5 x 2

17,5

2,00

**Eiszange**

ice tong
pinza para cubitos de hielo
pince à glaçons



matt poliert, mit griffigem Ende, ideal für Eiswürfel und Obstscheiben
satin polished finish, with handy end, ideal for ice cubes and fruit slices
pulido satinado, forma ergonómica ideal para cubitos de hielo y láminas de fruta
poli mat satiné, forme ergonomique idéale pour glaçons et fruits tranchés

cm

→ cm

€

93190

2 x 1,5

20

5,80

Abbildung in Originalgröße
illustration original size

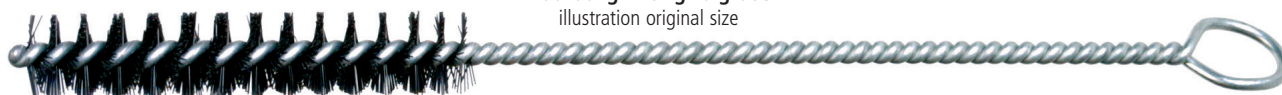
**Reinigungsbürste für Ausgießer**

pourer cleaning brush
cepillo de limpieza para picos vertedores
brosse lave-bouchons doseurs



→ cm

€

93102

16,5

2,50

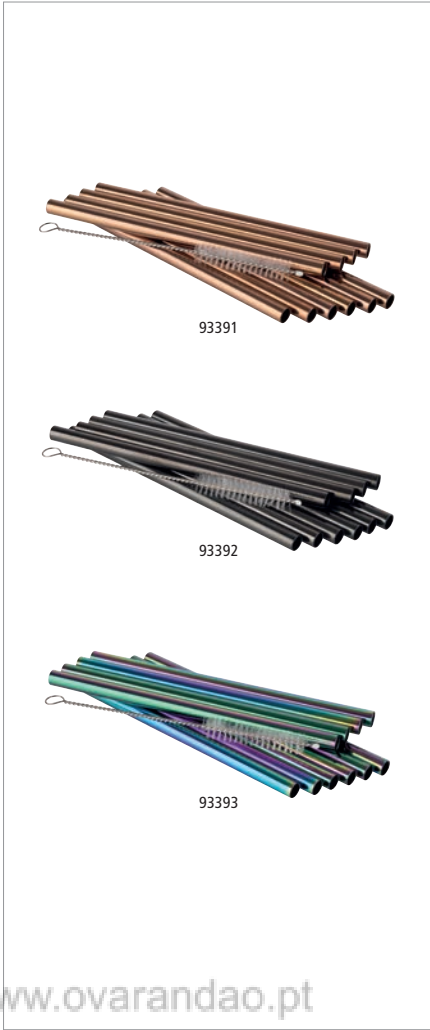

Trinkhalme 11er Set

straws, 11 pcs. set
pajas, set de 11 pz.
pailles, set de 11 pc.



11-teiliges Set: 10 Trinkhalme aus Edelstahl + Reinigungsbürste

11 pcs. set: 10 drinking straws made of stainless steel + cleaning brush
set de 11: 10 pajas de acero inoxidable + cepillo de limpieza
set de 11: 10 pailles en acier inox + brosse de nettoyage

	Ø mm	→ cm	Farbe / Colour	€/Set
93391	8	15,0		copper-look 11,00
93392	8	15,0		gunmetal-look 11,00
93393	8	15,0		rainbow-look 11,00
93380	6	21,5		copper-look 12,00
93381	6	21,5		gunmetal-look 12,00
93382	6	21,5		rainbow-look 12,00
93383	8	21,5		copper-look 13,00
93384	8	21,5		gunmetal-look 13,00
93385	8	21,5		rainbow-look 13,00

Ersatzbürste / replacement brush / cepillo de recambio / brosse de rechange

	Ø mm	→ cm	€
93395	8	15	1,20
93386	8	20	2,40



Trinkhalme 7er Set

straws, 7 pcs. set
pajas, set de 7 pz.
pailles, set de 7 pc.



	Ø mm	→ cm	pcs.	€/Set
93394	10	15	7	7,00
93390	10	21	7	8,00

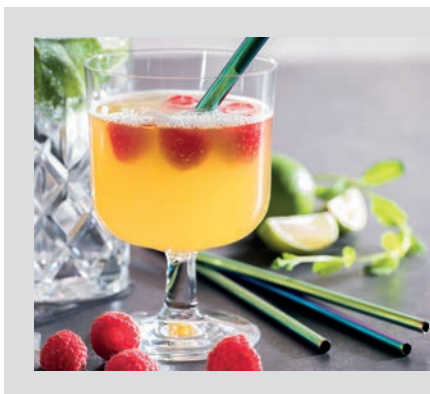



Barmatte

drip mat
tapete escurridor
tapis de bar

aus weichem Kunststoff, zum Abtropfen von Gläsern etc.
soft plastic, to store and drain glasses
plástico blando para escurrir vasos
plastique souple, pour l'égouttage des verres



	cm	↑ cm	Farbe / Colour		€
93166	30 x 15	1	■	ohne Vertiefung	6,50
93167	45 x 31	1	■	ohne Vertiefung	18,00
93173	52 x 8	1	■	ohne Vertiefung	7,80
93168	60 x 8	1	■	mit Vertiefung	8,50
93169	60 x 8	1	■	ohne Vertiefung	8,50



Abtropfmatte

drip mat
esterilla escurridora
tapis égouttoir
gerollt
rolled
enrollada
roulée



	cm	↑ cm	Farbe / Colour	€
93314	60 x 300	0,3	■	16,00
93315	60 x 300	0,3	■	16,00

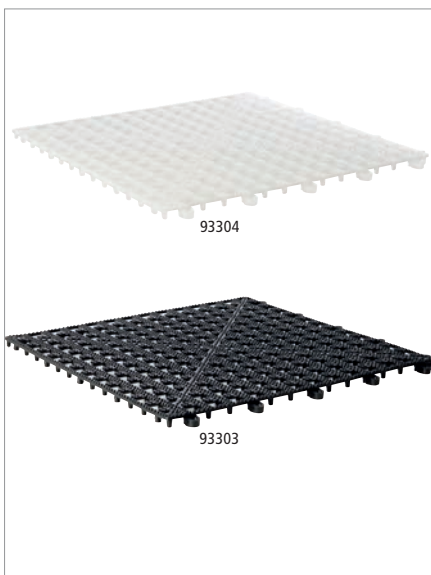

Abtropfmatte

drip mat
esterilla escurridora
tapis égouttoir

erweiterbar durch Klick-Verbindung
expandable
las placas de fijan con clips
avec clips de fixation



	cm	↑ cm	Farbe / Colour	€
93304	33 x 33	1,5	■	5,20
93303	33 x 33	1,5	■	5,20

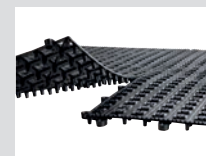



Zutatenbehälter

condiment holder
dispensador de especias
boîte à fruits et ingrédients



500 ml Inhalt pro Fach, 6 Fächer, inkl. Deckel (gefrostet) zur Lagerung
6 chambers á 500 ml, incl. lid for storing
6 compartimentos de 500 ml., incluye tapa para el almacenaje
6 compartiments de 500 ml chacun, avec couvercle pour le stockage

	cm	↑ cm	€
93171	50 x 16	10	19,00



Bar-Caddy

bar caddy
organizador de bar
organisateur „bar caddy“



Ordnungshilfe für Trinkhalme, Rührer, Servietten, Streichhölzer, etc.
to organize straws, stirrers, napkins, matches, etc.
para organizar pajitas, cucharillas, servilletas, cerillas, etc.
pour bien organiser les pailles, agitateurs, cuillers, serviettes et autres accessoires

	cm	↑ cm	€
93174	24 x 15	11	7,00



7 ltr.

Getränkspender „OLD FASHIONED“

beverage dispenser
dispensador de bebidas
distributeur de boissons



dicke, stabile Wände, weite Öffnung für große Zutaten, Gestell schwarz
thick, stable walls, a wide opening for large ingredients, black stand
tiene paredes gruesas y estables, amplia abertura para ingredientes grandes, soporte negro
des murs épais et stables, large ouverture pour de grands ingrédients, support noir

	Ø cm	↑ cm	ltr.	€
10409	24,5	50,5	7	inkl. Gestell / incl. stand 54,00



10,5 ltr.

Getränkspender „FRUITS“

beverage dispenser
dispensador de bebidas
distributeur de boissons



dicke, stabile Wände, weite Öffnung für große Zutaten, Gestell schwarz
thick, stable walls, a wide opening for large ingredients, black stand
tiene paredes gruesas y estables, amplia abertura para ingredientes grandes, soporte negro
des murs épais et stables, large ouverture pour de grands ingrédients, support noir

	Ø cm	↑ cm	ltr.	€
10415	25	58	10,5	inkl. Gestell / incl. stand 69,00

CONFERENCE



Flaschenkühler „CONFERENCE“

conference bottle cooler
enfriador múltiple
rafraîchisseur

inkl. Kühlakku, Flaschenöffner, Kronkorkenschale,
mit 6 Öffnungen Ø 6,7 cm für 0,25 - 0,5 Liter-Flaschen

incl. bottle cooler, bottle opener, small cap bowl,
with 6 holes Ø 6,7 cm for 0,25 to 0,5 liter bottles

con acumulador de frío, abridor, recuperador de chapas,
6 plazas Ø 6,7 cm, para botellas de 25 a 50 cl

avec accumulateur de froid, décapsuleur, bol récupérateur
de capsules, 6 places Ø 6,7 cm, pour bouteilles de 25 à 50 cl



	Ø cm	→ cm	Farbe / Colour	€
00620	23	15	White	46,00
00621	23	15	Black	46,00



Kühlakku

cooler
acumulador de frío
accumulateur de froid

	Ø cm	→ cm	Farbe / Colour	€
00616	7,5	11,5	White	10,00
00615	7,5	11,5	Black	10,00



Flaschenöffner

bottle opener
abridor
décapsuleur



	Ø cm	→ cm	€
00617	1	13,5	5,60



Kronkorkenschale

cap bowl
cuenco para chapas
bol récupérateur de capsules



	Ø cm	↑ cm	Farbe / Colour	€
00618	6,5	3	White	2,10
00619	6,5	3	Black	2,10

**Spritzflasche inklusive Ausgießer**

squeeze bottle with nozzle
botella exprimible con dosificador
flacon pulvérisateur avec bec verseur



ideal für Bitter-Liköre, Essig, Öl

perfect for bitter liqueur, vinegar, oil
perfecto para amargo licor, vinagre, aceite
pour amaro liquore, vinaigre, huile

	cm	↑ cm	ltr.	€
93308	6 x 5	20	0,2	9,00

Ausgießer passend für Spritzflasche / nozzle suitable for squeeze bottle / dosificador apto para botella exprimible / bec verseur approprié pour flacon pulvérisateur

	Ø cm	↑ cm	€
93309	2,5	5,5	2,60

**Rührglas mit Lippe**

mixing glass with lip
vaso mezclador vertedor con pico
verre mélangeur avec bec verseur



schwere Qualität

heavy quality
alta calidad
qualité renforcée

	Ø cm	↑ cm	ltr.	VE	€
93101	11,5	19	1	12	10,00



1:1 Oberflächenansicht
1:1 structural view

Rührglas mit Lippe

mixing glass with lip
vaso mezclador vertedor con pico
verre mélangeur avec bec verseur



	Ø cm	↑ cm	ltr.	€
93141	9	16	0,50	10,00

**Dosier- & Vorratsflasche**

pouring container
botella „store & pour“
bouteille „store & pour“



4-teilig: Behälter + Flaschenhals + Schraubdeckel + Ausgießer Ø 11 mm mit Luftzufuhr für gezieltes Ausgießen, zum Dosieren und Aufbewahren

4 pcs. set: for storage, mixing and serving drinks, nozzle Ø 11 mm

set de 4 piezas: para almacenar y servir mezclas y bebidas, agujero de Ø 11 mm

se compose de 4 pièces: idéal pour servir et pour conserver les boissons, embout Ø 11 mm

	Ø cm	↑ cm	ltr.	Farbe / Colour	€
93144	9	33	0,85		4,60
93145	9	33	0,85		4,60
93146	9	33	0,85		4,60
93147	9	33	0,85		4,60
93148	9	33	0,85		4,60



abnehmbarer Boden dient als Deckel
removable bottom serves as a lid

**Permanent-Ausgießer, 6er Set**

free flow pourer, 6 pcs. set
vertedor contínuos set 6 piezas
set de 6 bouchons verseurs continus

à 2 Stück: blau, rot, gelb

2 pcs of each colour: blue, red, yellow

2 piezas de cada color: azul, rojo, amarillo

2 par couleur: bleu, rouge, jaune



	Ø cm	↑ cm	pcs.	€
93111	3	7,5	6	4,50

**Permanent-Ausgießer, 6er Set**

free flow pourer, 6 pcs. set
vertedor contínuos set 6 piezas
set de 6 bouchons verseurs continus



	↑ cm	pcs.	€
93110	11	6	11,90

**Ausgießer, 2er Set**

pourers, 2 pcs. set
vertedores set 2 piezas
set de 2 bouchons verseurs



Portionierer 2 cl, schnelles und genaues Abmessen

2 cl, quick and exact measuring

2 cl. medición rápida exacta

2 cl mesure exacte et rapide

	↑ cm	pcs.	€
93115	10	2	13,00

**Permanent-Ausgießer, 6er Set**

free flow pourer, 6 pcs. set
vertedor contínuos set 6 piezas
set de 6 bouchons verseurs continus



	↑ cm	pcs.	€
93114	8	6	11,00

**Sekt-Verschluss, 2er Set**

stopper, 2 pcs. set
set de 2 tapones
set de 2 bouchons



matt poliert, innen Gummi Arabicum

satin polished finish, inside rubber arabicum, with inscription

acabado pulido mate, interior goma arábica con inscripción

poli mat satiné, intérieur gomme arabique

	Ø cm	↑ cm	pcs.	€
93160	4	5,5	2	8,20

**Champagner- / Sektkonservator**

champagne conservator
tapón conservador
bouchon de conservation



2-teilig: Überdruckpumpe + luftdichter Bügelverschluss mit Entlüftungsventil, Champagner und Sekt lassen sich nach dem Öffnen für längere Zeit frisch halten

2 pcs. set: overpressure pump + airtight swing-top with air valve, opened champagne and sparkling wine can be kept fresh for a longer time

set de 2 piezas: bomba a presión + tapón swing hermético con válvula de aire acero inox y plástico, el cava y las bebidas espumosas pueden conservarse y mantenerse por más tiempo.

set de 2 pièces: bombe à pression + bouchon swing hermétique avec valve - inox et plastique - enfin un moyen de conserver plus longtemps le champagne et autres vins mousseux

	Ø cm	↑ cm	Farbe / Colour	€
93126	4,5	12	■	24,00

Verschluss einzeln / stopper single / tapón individual / bouchon seul

	€
93127	13,00

**Wein-Vakuumpumpe**

vacuum wine pump
bomba de vacío para vino
pompe à vide pour le vin



inkl. 2 Stopfen, um offene Flaschen erneut zu versiegeln und den Wein zu konservieren

incl. 2 stoppers, to reseal open wine bottles and conserve the wine

incluye 2 tapones para cerrar perfectamente las botellas abiertas y conservar el vino

livrée avec 2 bouchons pour refermer les bouteilles tout en conservant le vin parfaitement

	Ø cm	↑ cm	€
93123	3,5	15	17,90

Weinpumpe-Ersatzstopfen, 2er Set / wine pump stopper, 2 pcs. set / tapones al vacío para el vino / set de 2 bouchons à vide pour le vin

	Ø cm	↑ cm	pcs.	€
93162	3	4,5	2	4,60

**Staubkappen, 2er Set**

dust & fly cap, 2 pcs. set
tapón antipolvo
bouchon anti-poussières et anti-insectes



schützt vor Staub und Insekten

protects for dust and insects

para proteger de la suciedad e insectos

pour protéger de la poussière et des insectes

	Ø cm	↑ cm	pcs.	Farbe / Colour	€
93161	4	8	2	■	4,20

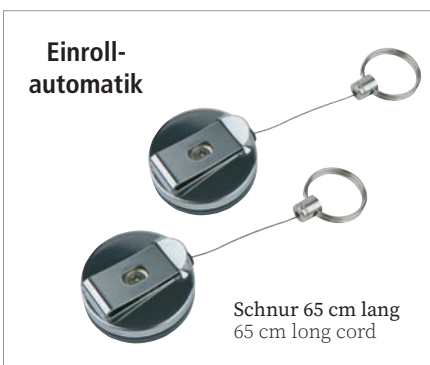
**Einroll-automatik**

Schnur 65 cm lang
65 cm long cord

Schlüsselschnur, 2er Set

key cord, 2 pcs. set
llavero enrollable
porte-clés avec cable à enroulement



Befestigung mit Klammer am Gürtel, starke Rückzugfeder

to fix at waistbelt, strong pull-back spring

se fija en el cinturón, cable retrocede automáticamente

à fixer à la ceinture, enroulage automatique

	Ø cm	↑ cm	€
93170	4	2	7,00

**Kellnermesser „PROFI“**

waiter's corkscrew
sacacorchos de camarero
tire-bouchons



leichtgängige Teflon-Spirale, mehrstufige Klapphebelfunktion, am Fuß angebrachtes Messer
easy moving teflon coil, 2-stage opening system, knife at the bottom end
mecha de teflón, sistema de apertura en 2 golpes, con cuchillo en la parte superior
mèche téflon, ouverture en 2 étapes, couteau dans la partie supérieure

	→ cm	€
93302	11,5	9,90

**Kellnermesser**

waiter's corkscrew
sacacorchos de camarero
tire-bouchons



leichtgängige Teflon-Spirale, mehrstufige Klapphebelfunktion, am Kopf angebrachtes Messer
easy moving teflon coil, 2-stage opening system, knife at the top end
mecha de teflón, sistema de apertura en 2 golpes, con cuchilla en la parte superior
mèche téflon, ouverture en 2 étapes, couteau dans la partie supérieure

	→ cm	€
93301	12	4,80

**Kellner-Flaschenöffner**

waiter's barblade
abridor camarero
décapsuleur
matt poliert



satin polished finish
pulido acabado mate
poli mat

	cm	€
93122	18 x 4	3,40



mit Gummierung

Kellner-Flaschenöffner

waiter's barblade
abridor camarero
décapsuleur



mit Gummierung
with rubber coating
con revestimiento de goma
avec revêtement en caoutchouc

	cm	€
93125	11 x 4	3,90

**Kronkorkenöffner**

bottle cap opener
abridor de chapas de pared
décapsuleur mural



für die Wandmontage, aus massivem Metall
for wall fastening, massive metal
para fijación en la pared, metal macizo
massif, à fixer au mur

	cm	↑ cm	€
93124	7 x 8	3	9,90

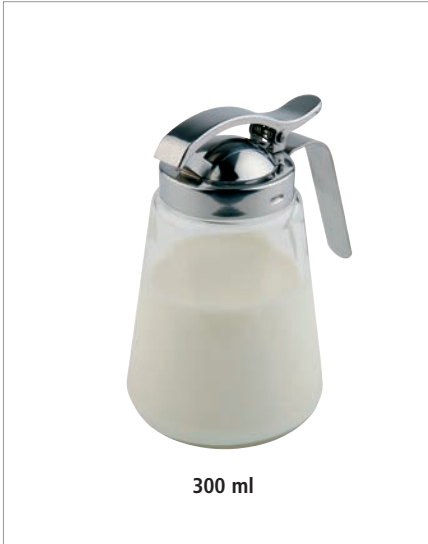

300 ml

Allzweckgießer

pourer
bote vertedor universal
pot verseur universel



für Honig, Kaffeesahne, etc., Schraubdeckel aus Edelstahl
for honey, cream, etc., cover stainless steel
para miel, crema, etc., tapa inoxidable
pour le miel, le lait, la crème, etc., couvercle inox

	Ø cm	↑ cm	ltr.	€
00765	8,5	13,5	0,3	6,60

Ersatzglasbehälter / spare glass-container / contenedor de repuesto / récipient verre de rechange

	€
00768	1,80



300 ml

Zuckerdosierer

sugar dispenser
azucarero
sucrier



Schraubdeckel aus Edelstahl
cover stainless steel
tapa inoxidable
couvercle inox

	Ø cm	↑ cm	ltr.	€
00766	8,5	15	0,3	3,50

Ersatzglasbehälter / spare glass-container / contenedor de repuesto / récipient verre de rechange

	€
00768	1,80

40490
150 ml40494
250 ml**Zuckerdosierer**

sugar dispenser
azucarero
sucrier



Schraubdeckel aus Edelstahl, mit Dosierrohr
cover stainless steel with dosingtube
tapa inoxidable y tubo dosificador
couvercle inox et tube doseur

	Ø cm	↑ cm	ltr.	€
40490	8,5	12	0,15	2,90
40494	8,0	15	0,25	2,90

Ersatzglasbehälter / spare glass-container / contenedor de repuesto / récipient verre de rechange

	fits to	€
40498	40490	1,60
40499	40494	1,60

**Zuckerdosierer**sugar dispenser
azucarero
sucrier**Schraubdeckel aus Edelstahl, mit Dosierrohr**cover stainless steel, with dosing tube
tapa inoxidable y tubo, con cierre dosificador
couvercle inox et tube doseur

	Ø cm	↑ cm	ltr.	€
40509	6	14,5	0,2	10,40

**Allzweckgießer**pouer
dosificador
doseur**Schraubdeckel aus Edelstahl und Kunststoff, mit Dosierklappe**cover stainless steel and plastic, with dosing flap
acero inoxidable y tapa plástico, con cierre dosificador
couvercle en inox et plastique, avec couvercle doseure

	Ø cm	↑ cm	ltr.	€
40488	8	12,5	0,25	5,60

**Zuckerdosierer**sugar dispenser
azucarero
sucrier**Schraubdeckel aus Edelstahl, mit Dosierrohr**cover stainless steel, with dosing tube
tapa inoxidable y tubo, con cierre dosificador
couvercle inox et tube doseur

	Ø cm	↑ cm	ltr.	€
40486	8	15	0,25	2,90

**Zuckerdosierer**sugar dispenser
azucarero
sucrier**Schraubdeckel aus Edelstahl, mit Dosier-Rohr**cover stainless steel, with dosing tube
tapa inoxidable y tubo dosificador
couvercle inoxydable et tube doseur

	Ø cm	↑ cm	ltr.	€
40506	7,5	17,0	0,32	4,20

**Zuckerdosierer**sugar dispenser
azucarero
sucrier**Schraubdeckel mit Klappe aus Edelstahl, mit Dosierklappe**cover stainless steel, with dosing flap
tapa acero inoxidable, con cierre dosificador
couvercle inox, avec couvercle doseure

	Ø cm	↑ cm	ltr.	€
40487	7,5	13,5	0,32	3,60

**Zuckerdosierer „OLD FASHIONED“**

sugar dispenser
azucarero
sucrier



Schraubdeckel mit Klappe aus Edelstahl, mit Dosierklappe

cover stainless steel, with dosing flap
tapa acero inoxidable, con cierre dosificador
couvercle inox, avec couvercle doseuse

	Ø cm	↑ cm	ltr.	€
40510	7,5	14	0,35	3,60

**Zuckerdosierer**

sugar dispenser
azucarero
sucrier



mit Schraubverschluss, Dosier-Rohr Ø 15 mm

cover and dosingtube Ø 15 mm
con tapa y tubo dosificador Ø 15 mm
couvercle avec tube doseur Ø 15 mm

	Ø cm	↑ cm	ltr.	€
40508	6,5	14,5	0,20	9,90

**Zuckerspender / Milchkännchen**

sugar pourer / milk jug
dispensador de azúcar
sucrier doseur



matt poliert

satin polished finish
pulido efecto satinado
intérieur et extérieur poli mat

	Ø cm	↑ cm	ltr.	€
10316	5	15	0,17	8,60

**Teekanne „ASIA“**

teapot
tetera
théière



aus Gusseisen, innen emailliert, hält den Tee lange warm,
kein nachbittern, ideal für zwei Tassen

made of cast iron, keeps the tea warm for
a long time, no bitterness, ideal for two cups

hecho de hierro fundido, mantiene el té caliente durante
mucho tiempo, sin amargar, ideal para dos tazas

en fonte, maintient le thé chaud pendant longtemps,
pas d'amertume, idéal pour deux tasses

	Ø cm	↑ cm	ltr.	€
10990	12,5 x 11	12,5	0,3	19,00



mit abnehmbarem Deckel
with removable lid

**Milch-/Universalkanne „ANTIHAFT“**

non stick jug
jarra antiadherente
pichet antiadhésif



PTFE-antihaftbeschichtet, perfekt für die Herstellung von Milchschaum

PTFE coated, for baristas frothing hot milk
revestimiento PTFE, ideal para espume de leche
revêtement PTFE, idéal pour faire mousser le lait

	Ø cm	↑ cm	ltr.	€
10334	8,0	10,0	0,35	13,80
10335	9,0	11,5	0,6	16,90
10336	10,5	13,0	0,8	22,40

**Milch- / Universalkanne**

milk / water jug
jarra leche / agua
pichet à eau / lait



außen hochglanzpoliert, innen matt poliert

outside mirror polished finish, inside satin polished finish
exterior brillante, interior satinado
extérieur brillant, intérieur mat satiné

	Ø cm	↑ cm	ltr.	€
10328	8,0	10,0	0,35	6,80
10329	9,0	11,5	0,6	10,00
10330	10,5	13,0	0,8	13,50
10331	12,0	16,5	1,3	18,50
10332	13,5	18,0	2,0	24,00

**Kaffeekanne**

coffee pot
cafetera
pichet à café



hochglanzpoliert, mit Klappdeckel

mirror polished finish, with hinged cover
acabado brillante, tapa con bisagra
poli brillant, couvercle à charnière

	Ø cm	↑ cm	ltr.	€
10323	8,0	11,5	0,35	8,80
10322	9,0	14,0	0,6	12,00
10325	10,5	15,5	0,9	16,50
10326	12,0	18,5	1,5	22,50
10327	13,5	20,0	2,0	28,00

**Milchkännchen / Sahnegießer**

milk / cream jug
jarra de leche/ crema
pichet à eau ou lait



	Ø cm	↑ cm	ltr.	€
10318	4	4	0,05	2,00
10319	5	5	0,09	2,40
10320	6	6	0,15	3,00

**Milchkännchen, 4er Set**

milk/cream jugs, 4 pcs. set
pack de 4 jarritas para leche o crema
pack de 4 crémiers



hochglanzpoliert, für Kaffeesahne, mit Griff, Inhalt à 25 ml
mirror polished finish, for coffee-cream, with handle, capacity à 25 ml
pulido brillante, para crema de café, con asa, capacidad 25 ml
brillant, avec anse, 25 ml

	Ø cm	↑ cm	pcs.	ltr.	€
10321	3,5	3,5	4	0,025	12,90

**Milch- und Zucker-Set**

milk and sugar set
set de leche y azúcar
set sucrier et crémier



Set bestehend aus: Tablett 21 x 14 cm, H: 1,5 cm; Zuckerdose Ø 8cm, H: 7 cm;
Milchkännchen Ø 6 cm, H: 8 cm, 0,2 Liter, Löffel

set consisting of: tray 21 x 14 cm, h: 1,5 cm; sugar bowl Ø 8cm, h: 7 cm;
milk jug Ø 6 cm, h: 8 cm, 0,2 ltr., spoon

set compuesto por: bandeja 21 x 14 cm, a: 1,5 cm; azucarero Ø 8cm, a: 7 cm;
jara de leche Ø 6 cm, a: 8 cm, 0,2 L., cuchara

ensemble composé de: plateau 21 x 14 cm, h: 1,5 cm; sucrier Ø 8cm, h: 7 cm;
crémier Ø 6 cm, h: 8 cm, 0,2 l, cuillère

	cm	↑ cm	€
00638	21 x 14	7	25,00

Ersatzlöffel / replacement spoon / cuchara de recambio / cuillère de rechange

	→ cm	€
00639	12	2,00



00638

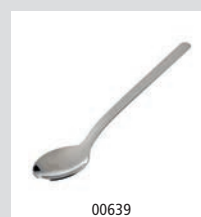

00639

**Zuckertüten-Box**

sugar pocket holder
azucarero para bolsitas
porte-sachetsw de sucre



matt poliert, für ca. 15 Zuckertüten
satin polished finish, for ca. 15 sugar packets
acabado pulido efecto satinado, capacidad 15 sobrecillos
poli mat, pour 15 sachets

	cm	↑ cm	€
11579	9 x 7,5	5	8,00

**Zuckerkugel**

sugar pot
azucarero
sucrier



hochglanzpoliert, mit Rolldecke
mirror polished finish, rolltop cover
pulido acabado brillante, tapa abatible
brillant, couvercle abattant

	∅ cm	↑ cm	€
00033	13,5	15	10,90

**Teebrühsieb**

snap mesh tea ball
infusor de té, pinza con malla
boule à thé avec pince



matt poliert, mit feinem Sieb, aufklappbar
satin polished finish, with fine mesh, hinged
acabado pulido efecto satinado, con malla fina, con bisagra
inox mat, maille fine, avec charnière

	∅ cm	→ cm	€
74750	4,5	15,5	2,10

**Zitronenschnitzelpresse**

lemon slice squeezer
pinza exprimelimon
pinze presse citron



hochglanzpoliert, zum Auspressen von Zitronenscheiben
mirror polished finish, to press lemon slices
pulido brillante, para rodajas de limón
brillant, pour citrons en rondelle

	cm	€
71430	8 x 7	1,20

**Schale, 2-geteilt**

bowl, 2-section
cuenco, 2 secciones
bol 2 compartiments



	cm	↑ cm	€
83538	17,5 x 7,5	4,5	5,00

**Flambierbrenner**

chefs blow torch
soplete de cocina para flambeare
chalumeau de cuisine



mit handelsüblichem Feuerzeuggas auffüllbar, Flamme einstellbar
bis ca. 1300° C, Brenndauer von min. 60 Minuten

to be filled with commercial lighter gas, flame adjustable up to
approx. 1300° C, burning time of at least 60 minutes

rellenable con gas de mechero comercial, llama ajustable
hasta 1300° C, tiempo de combustión de al menos 60 minutos

rempli avec gaz pour briquet commercial, flamme réglable
jusqu'à 1300° C, temps de combustion d'au moins 60 minutes

	∅ cm	↑ cm	€
77315	4,5	16,5	29,00



Tablett „VINTAGE“

tray
bandeja
plateau

Edelstahl-Look vintage
stainless steel vintage look
acero inoxidable look vintage
acier inox look vintage

	cm	↑ cm	€
30130	26,0 x 13,5	1,5	7,00
30131	34,0 x 18,0	1,5	12,00
30132	38,0 x 26,5	1,5	19,00
30133	25,5 x 16,0	3,0	14,00



passende Schälchen / fitting bowls / cuencos adecuados / bols apropiés

	Ø cm	↑ cm	ltr.	€
40655	7,5	5,5	0,17	2,60
40656	7,5	10	0,35	3,20



Servierbeispiel
presentation example



Servierkelle „BOB“

serving trowel
paleta para servir
truelle de service

Edelstahl Servierkelle mit schwarzem Holzgriff
stainless steel serving trowel with black wooden handl
paleta para servir de acero inoxidable con mango de madera negra
truelle de service en acier inox avec manche en bois noir



	cm	↑ cm	Griff	€
40680	23,5 x 15,5	12,5	13,5 stainless steel	16,00
40681	23,5 x 15,5	12,5	13,5	16,00



hot price

Serviertablett „KAFFEEHAUS“

tray
bandeja
plateau

Innenfläche ziseliert, Rand eingerollt

rolled edge

borde redondeado, superficie decor relieve

bord rond, surface entièrement ciselée

	cm	pcs.	€
30114	30 x 22	48	2,80



84251

Serviertablett „KAFFEEHAUS“

tray
bandeja
plateau

	cm	↑ cm	Farbe / Colour	€
84251	26,0 x 20,0	1,5	■	4,20
84253	28,5 x 21,5	1,5	■	4,80



Serviertablett „KAFFEEHAUS“

tray
bandeja
plateau

matt poliert, Rand eingerollt

satin polished finish, rolled edge

acabado pulido efecto satinado, borde redondeado

effet satin, bord rond

	cm	↑ cm	€
30118	21,5 x 13	1,5	7,20



Serviertablett „KAFFEEHAUS“

tray
bandeja
plateau

matt poliert, Rand eingerollt

satin polished finish, rolled edge

acabado pulido satinado, borde redondeado

effet satin mat, bord rond

	cm	↑ cm	€
30119	23 x 23	1,5	10,50

**Serviertablett „KAFFEEHAUS“**

tray
bandeja
plateau

matt poliert, oval, Rand eingerollt

satin polished finish, oval, rolled edge

pulido acabado efecto satinado, oval, borde redondeado

effet satin, ovale, bord rond



30111

matt poliert
satin polished finish

	cm	↑ cm		€
30111	19,0 x 15,0	1	für Zucker und Sahne / for sugar and cream para azúcar y crema / pour le sucre et la crème	4,30
30112	26,5 x 19,0	1	für eine Tasse / for one cup para una taza / pour une tasse	6,50
30113	29,0 x 22,0	1	für zwei Tassen / for two cups para dos tazas / pour deux tasses	6,90
30123	23,0 x 17,5	1	Eisdielen-Größe / icecream pralor size tamaño especial para heladerías / taille spéciale pour glaciers	6,10

Serviertablett „KAFFEEHAUS“

tray
bandeja
plateau

hochglanzpoliert, oval, Rand eingerollt

mirror polished finish, oval, rolled edge

pulido efecto espejo, ovalado, borde redondeado

effet brillant, ovale, bord rond



30116

hochglanzpoliert
mirror polished finish

	cm	↑ cm		€
30115	19,0 x 15,0	1	für Zucker und Sahne / for sugar and cream para azúcar y crema / pour le sucre et la crème	4,30
30116	26,5 x 19,0	1	für eine Tasse / for one cup para una taza / pour une tasse	6,50
30117	29,0 x 22,0	1	für zwei Tassen / for two cups para dos tazas / pour deux tasses	6,90

Serviertablett „KAFFEEHAUS“

tray
bandeja
plateau

mattiert

satin polished finish

acabado efecto satinado / fini mat effet satin



mattiert
satin polished finish

	cm	↑ cm		€
30126	25,5 x 19,5	2	mattiert / satin polished finish acabado efecto satinado / fini mat effet satin	6,30



Serviertablett „HAPPY HOUR“

tray
bandeja
plateau



rutschfeste Oberfläche
non-slip surface
superfície anti-deslizante
surface antidérapante

	Ø cm	↑ cm	Farbe / Colour	€
00510	32	1,5	■	20,60
00511	38	1,5	■	25,00
00515	43	1,5	■	28,90



00548

Tablett „GASTRO“

tray
bandeja
plateau



rutschfeste Oberfläche
non-slip surface
superfície anti-deslizante
surface antidérapante

	Ø cm	↑ cm	Farbe / Colour	€
00547	27,5	2	■	6,90
00548	35,5	2	■	8,70
00549	40,5	2	■	10,50



Tablett „BISTRO“

tray
bandeja
plateau



rutschfest, mit 2 Griffmulden und Stapelrand
non-slip, two open handles, stackable edge
anti-deslizante, 2 asas
antidérapant, 2 anses

	Ø cm	↑ cm	Farbe / Colour	€
84045	35,5	4,5	■	22,00



00500

00507

Bierglasträger „NON-SLIP“

beer rack
bandeja para cerveza
porte verre à bière



rutschfeste Oberfläche
non-slip surface
superfície anti-deslizante
surface antidérapante

	Ø cm	↑ cm	Farbe / Colour	€
00500	36	3,5	■	19,00
00501	36	3,5	■	19,00

	cm	↑ cm	Farbe / Colour	€
00506	28 x 20	1,5	■	8,50
00507	28 x 20	1,5	■	8,50

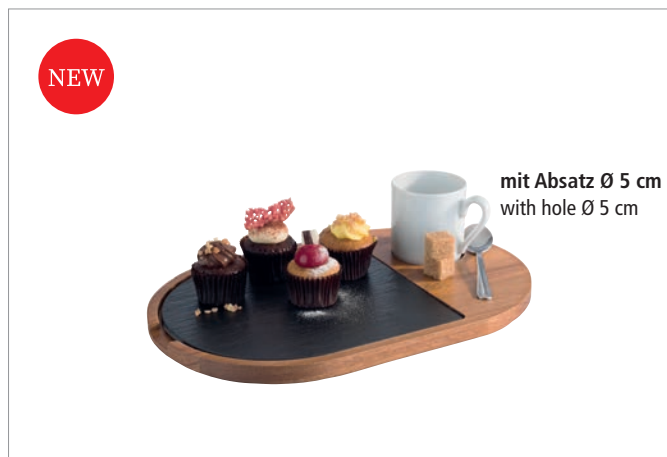
**Servierbrett, 2-tlg.**

serving board, 2 pcs. set
tabla de servir, set de 2
planche de service, set de 2

**2-teilig:**

1 Holzbrett aus Akazienholz + 1 Naturschieferplatte

1 wood board made of acacia wood + 1 natural slate tray

1 tabla de madera de acacia + 1 pizarra natural

1 planche en bois d'acacia + 1 ardoise naturelle

	cm	↑ cm	€
00814	28 x 17,5	2,0	14,00

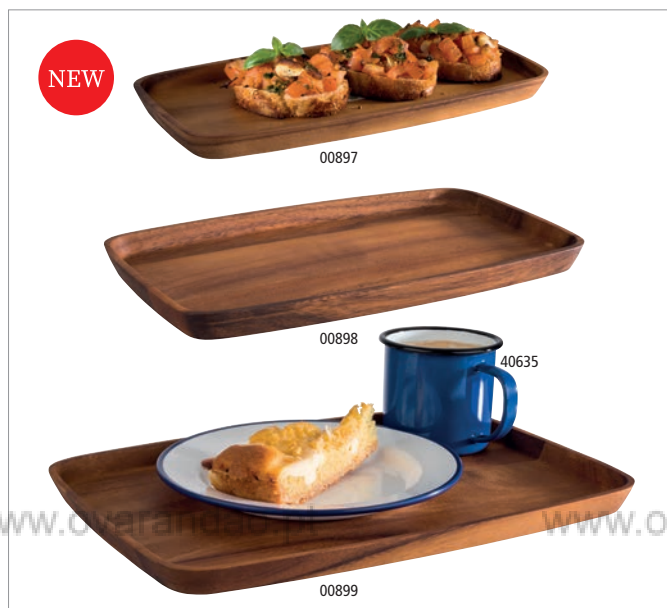
**Servierbrett**

serving board
tabla de servir
planche de service



Servierbrett aus geöltem Akazienholz

serving board made of oiled acacia wood

tabla de servir de madera de acacia aceitada

planche en bois avec plateau en bois d'acacia huilé

	cm	↑ cm	€
00897	30 x 15	2,0	12,00
00898	30 x 18	2,0	14,00
00899	35 x 25	2,0	20,00

**Serviertablett „NON-SLIP“**

tray non-slip
bandeja antideslizante
plateau antiglisse

rutschfeste Oberfläche

non-slip surface

superficie antideslizante

surface antidérapante



	cm	↑ cm	GN	€
00502	53 x 32,5	1,5	1/1	21,90
00508	46 x 36,0	2		20,80
00505	53 x 32,5	1,5	1/1	21,90
00503	53 x 37,0	1,5		25,00

**Tablett**

tray
bandeja
plateau



rutschfest, Holzdekor-Laminat

non-slip, coated wood

antideslizante

antidérapant

	cm	↑ cm	€
00524	43,5 x 31,5	1,5	17,20
00525	52,0 x 39,0	1,5	21,80
00526	60,5 x 42,5	1,5	27,50

**Fast Food-Tablett**

snack tray

bandeja autoservicio y snacks

plateau self-service et snacks



	cm	↑ cm	GN	Farbe / Colour	€
00530	35 x 27,0	2			3,10
00535	41 x 30,5	2			4,10
00540	45 x 35,5	2			5,10
00552	53 x 32,5	2	1/1		6,20

	cm	↑ cm	GN	Farbe / Colour	€
00531	35 x 27,0	2			3,10
00536	41 x 30,5	2			4,10
00541	45 x 35,5	2			5,10
00553	53 x 32,5	2	1/1		6,20

	cm	↑ cm	GN	Farbe / Colour	€
00532	35 x 27,0	2			3,10
00537	41 x 30,5	2			4,10
00542	45 x 35,5	2			5,10
00554	53 x 32,5	2	1/1		6,20

	cm	↑ cm	GN	Farbe / Colour	€
00533	35 x 27,0	2			3,10
00538	41 x 30,5	2			4,10
00543	45 x 35,5	2			5,10
00555	53 x 32,5	2	1/1		6,20



00528

Tablett

tray

bandeja

plateau

**rutschfest, Mahagonifurnier**

non-slip, woodform, mahogany

antideslizante

antidérapant

	Ø cm	↑ cm	€
00528	31,0	3,5	17,20
00529	35,5	3,5	21,90



rutschfest / non-slip



00522

Tablett

tray

bandeja

plateau

**rutschfest, Holzdekor-Laminat**

non-slip, coated wood

antideslizante

antidérapant

	cm	↑ cm	€
00521	26 x 20	1	7,60
00522	29 x 21	1	9,90

**Rechnungstablett**

bill presenter
porta cuenta
porte-addition



mit Klemme für Rechnung
with clip for bill
con clip para la nota
avec clip pour la note

	cm	↑ cm	€
30108	20 x 12	0,5	1,70

**Rechnungstablett**

bill presenter
porta cuenta
porte-addition



mit Klemme für Rechnung
with clip for bill
con clip para la nota
avec clip pour la note

	cm	↑ cm	€
30110	17 x 11	1	5,80

**Rechnungstablett, 2er Set**

bill presenter, 2 pcs. set
porta cuenta, set de 2
porte-addition, set de 2



1 Edelstahl-Tablett hochglanzpoliert + 1 klappbare Ledermappe
mit Stiftflasche, mit Magnethalterung

1 stainless tray mirror polished finish + 1 leather presenter, with magnetic system

1 bandeja de acero inoxidable pulido brillante + 1 presentador de cuero con sistema magnético

1 plateau inox poli brillant + 1 pochette cuir aimantée

	cm	↑ cm	€
30109	20 x 16	2	24,40

**Tischkrümelentferner**

crumber
recogemigas
ramasse-miettes



matt poliert

satin polished finish

acabado mate, fácil de usar, mango hueco

mat satiné, manche creux, simple à utiliser

	Ø cm	↑ cm	€
00058	6,5 x 2,5	22	14,80
00581	19,5 x 4,5	1	7,20

Hohlgriff / hollow handles

geschliffene Edelstahlkante

flat grinded stainless steel edge



Windaschenbecher „DIAMOND“

ashtray
cenicero
cendrier



Metall verchromt, mit Bajonettverschluss

metal chrome plated, bayonet lock

metal cromado, cierre de bayoneta

metal chrome, verrouillage par baïonnette

	Ø cm	↑ cm	Farbe / Colour		€
00565	12	8,0		Glas gefrostet / glass frosted	9,90
00566	12	8,0		Glas glänzend / glass shiny	9,90
00567	12	8,0		Glas glänzend / glass shiny	9,90



Windaschenbecher

ashtray
cenicero
cendrier



Metall verchromt, Glas gefrostet, mit Bajonettverschluss

metal chrome plated, glass frosted, bayonet lock

metal cromado, opaco mate, cierre de bayoneta

métal chromé, mat, verrouillage par baïonnette

	Ø cm	↑ cm	Farbe / Colour		€
00560	9,5	8			8,40
00561	9,5	8			8,40
00562	9,5	8			8,40
00563	9,5	8			8,40
00564	9,5	8			8,40





Drehaschenbecher „PUSH“

ashtray
cenicero
cendrier



Deckel mit Drehmechanismus, mit Bajonettverschluss
with rotary button, bayonet lock
con botón giratorio, cierre de bayoneta
tourne par pression sur le bouton, verrouillage par baïonnette



Drehmechanismus
rotary button

	Ø cm	↑ cm	€
00568	9,5	11	9,90



00583

00584

Windaschenbecher

ashtray
cenicero
cendrier



Metall verchromt, Glas gefrostet, mit Bajonettverschluss
metal chrome plated, glass frosted, bayonet lock
metal cromado, opaco mate, cierre de bayoneta
métal chromé, mat, verrouillage par baïonnette

	Ø cm	↑ cm	Farbe / Colour	€
00582	9,5	8	Black	8,40
00583	9,5	8	Yellow	8,40
00584	9,5	8	Teal	8,40
00585	9,5	8	White	8,40



00582

00585



00054

00056

Drehaschenbecher „KLASSIKER“

ashtray
cenicero
cendrier giratoire



Deckel mit Drehmechanismus
with rotary button
con botón giratorio
tourne par pression sur le bouton

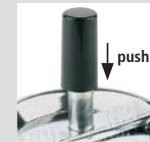

Drehmechanismus
rotary button

	Ø cm	↑ cm	Farbe / Colour	€
00054	13,0	10,5	Silver	7,90
00056	10,5	11	Black	6,40



Aschenbecher

ashtray
cenicero
cendrier



Deckel hochglanzpoliert, Behälter matt poliert, mit Windschutzdeckel
lid mirror polished finish, container satin polished finish, with windcover
con tapa antiviento pulida brillante y contenedor pulido efecto satinado
couvrele anti-vent brillant, corps poli mat satiné

	Ø cm	↑ cm	€
00052	12	5,5	8,60

**Windaschenbecher**ashtray
cenicero
cendrier

	Ø cm	↑ cm	Farbe / Colour	€
83488	11,5	5	■	5,40
83489	11,5	5	■	5,40

**Windaschenbecher**ashtray
cenicero
cendrier

	Ø cm	↑ cm	Farbe / Colour	€
83610	10	4,0	■	4,40
83612	12	4,5	■	4,80
83611	10	4,0	■	4,40
83613	12	4,5	■	4,80

**Aschenbecher**ashtray
cenicero
cendrier

	Ø cm	↑ cm	Farbe / Colour	€
83614	9,5	4,5	■	2,50
83616	9,5	4,5	■	2,50

**Aschenbecher**ashtray
cenicero
cendrier**matt poliert, mit Windschutzdeckel**

satin polished finish, with windcover

acabado pulido satinado apilable, tapa para el viento

poli mat, empilable, couvercle anti-vent

	Ø cm	↑ cm	€
00090	10	4,5	7,50
00091	12	4,5	8,00

**Aschenbecher**ashtray
cenicero
cendrier**matt poliert, hochwertige schwere Ausführung**

satin polished finish, high quality, heavy gauge

pulido satinado, alta calidad, apilable

poli mat, empilable, belle qualité

	Ø cm	↑ cm	€
00048	8	3	7,40
00050	10	3	8,50



NEW

Windaschenbecher „SMOKY“

ashtray
cenicero
cendrier

Metall schwarz, mit abnehmbarem Deckel
metal black, with removable lid
metal negro, con tapa extraíble
métal noir, avec couvercle amovible

	Ø cm	↑ cm	Farbe / Colour	€
00586	8,5	11,5	■	5,00



Windaschenbecher „SMOKY“

ashtray
cenicero
cendrier

Metall verzinkt, mit abnehmbarem Deckel
metal galvanized, with removable lid
metal galvanizado, con tapa extraíble
métal galvanisé, avec couvercle amovible

	Ø cm	↑ cm		€
00578	8,5	11,5		5,00



NEW

Windaschenbecher 4er Set „MINI“

ashtray
cenicero
cendrier

	Ø cm	↑ cm	pcs.	Farbe / Colour	€ / set
83620	6,5	5,5	4	■	9,00
83621	6,5	5,5	4	■	9,00



83621



83620

stapelbar
stackable

Windaschenbecher „ELEMENT“

ashtray
cenicero
cendrier

Beton, mit möbelschonender Unterseite
concrete, with non-scratching undersurface
hormigón, con base anti rayaduras
béton, avec revêtement antirayures

	Ø cm	↑ cm	pcs.	€ / pc.
00570	10,5	5,0	3	6,90



hot price

Aschenbecher, 3er Set

ashtray, 3 pcs. set
set de cenicero 3 piezas
set de 3 mini cendriers

	Ø cm	↑ cm	pcs.	Farbe / Colour	€ / pc.
00576	8	3	3	■	2,20

**Standascher „DIABOLO“**

standing ashtray
cenicero de pie
cendrier sur pied



für den Innen- und Außenbereich, inkl. 1,5 kg Sand, eine Ascheschale für die Sandbefüllung und ein Metallsieb

for in,- outdoor use, included a bag of sand and a metal sieve

uso en interior o exterior, incluye una bolsa de arena y embudo de metal

usage en intérieur ou extérieur, livré avec un sac de sable et entonnoir métal

	Ø cm	↑ cm	€
00574	40	60	64,00



vielseitig nutzbar
versatile

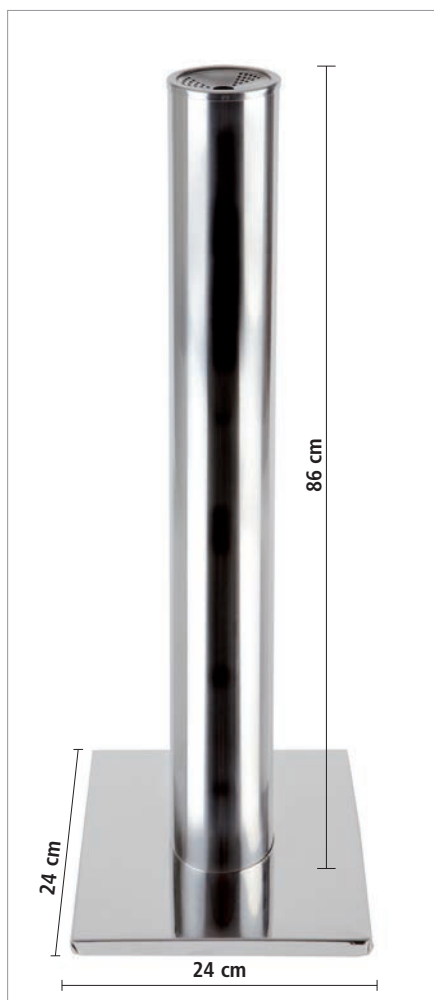

zerlegbar und stapelbar
dismountable and stackable

**Standascher / Abfalleimer „SMOKERS POINT“**

floor standing ashtray
cenicero de pie
cendrier sur pied



glanz poliert, mit herausnehmbaren Aschereinsatz

mirror polished finish, with ashtray insert and with litter bin

pulido acabado con cenicero y papelera

poli brillant inséré, extractible pour vidage facile

	Ø cm	↑ cm	ltr.	€
00579	9 / 24 x 24	86	3	114,00



3 Liter Einsatz
3 litre ashtray insert





71400

Rezeptionsglocke

ring bell
timbre
sonnette



	Ø cm	↑ cm	Farbe / Colour	€
71400	8,5	6,0	■	4,90
71433	10,0	6,5	■	7,20



30 cm

60 cm

Standascher / Abfalleimer

litter bin / ashtray
papelera con cenicero superior
poubelle avec cendrier supérieur



mit herausnehmbaren Aschereinsatz und herausnehmbaren verzinkten Innenbehälter / Eimer
with ashtray insert and litter bin
con cenicero y papelera metálica
cendrier et corbeille à détritrus

	Ø cm	↑ cm	€
00575	30	60	52,00



55 cm

82 cm

Gummilippe 55 cm breit,
Abstand zwischen Gummilippe
und Bodenblech 82 cm

Tretbeutelhalter

pedal bin
soporte a pedal
poubelle à pédale



geeignet für Müllbeutel bis 120 ltr., 110 x 70 cm
suitable for bags up to 120 ltr., 110 x 70 cm
apto para bolsas hasta 120 l., medidas sin bolsa 110 x 70 cm
apte pour sacs de 120 l., dim. sans sac 110 x 70 cm

	cm	↑ cm	€
00580	59 x 43	96	114,00



leichte Bedienung, Trittmehanismus
easy handling, step on bin



2 Lenkrollen mit Feststellern
2 wheels with brakes



www.ovarandao.pt

www.ovarandao.pt

www.ovarandao.pt

www.ovarandao.pt

www.ovarandao.pt

www.ovarandao.pt

www.ovarandao.pt

www.ovarandao.pt

www.ovarandao.pt

Servier- & Küchenhelfer

serving items & kitchentools
herramientas de cocina
outils de cuisine

Kellen
Schnitzer
Wender
Zangen
Löffel

ladles
carvers
turners
tongs
spoons

cucharones
talladores
espátulas
pinzas
cucharas

louches
bourdes
spatules
pincés
cuillères



220°C
POLYAMID
BEST TECHNOLOGY

Das Profimaterial Polyamid besteht aus Nylon und Fiberglas. Hitzebeständig bis 220°C, extra hochwertige Profi-Qualität, gut geeignet für antihafbeschichtete Pfannen, ergonomischer Griff.

Polyamide is made of nylon and fiberglass. Heat-resistant up to 220°C, extra high quality, perfect for non-stick-coated pots and pans, ergonomic handle.

Poliamide de nylon y fibra de vidrio. Brevemente al calor hasta 220°, calta calidad profesional, ideal para sartenes antiadherentes, mango ergonómico.

Polyamide de nylon et fibre de verre, haute résistance brièvement à la chaleur jusque 220°C, qualité professionnelle, idéal pour les poêles antiadhérentes, manche ergonomique.



Bratenwender

turner
espátula
spatule



	cm	→ cm	€
00603	11 x 9,5	Griff / handle 23	5,30



Pfannenwender

turner
espátula
spatule



	cm	→ cm	€
00600	11,5 x 9,5	Griff / handle 23	5,20



Pfannenwender

turner
espátula
spatule



	cm	→ cm	€
00604	15 x 7,5	Griff / handle 15	3,70



Pfannenwender

turner
espátula
spatule



	cm	→ cm	€
88642	13,5 x 9	Griff / handle 18	3,80



Pfannenwender

turner
espátula
spatule



	cm	→ cm	€
88640	13 x 6,5	Griff / handle 15	3,70

**Servierlöffel**

serving spoon
cuchara de servicio
cuillère de service



	cm	→ cm		€
88608	12 x 7	Griff / handle 23		5,20
00607	12 x 7	Griff / handle 23	perforiert	5,00

**Schaumlöffel**

skimmer
espumadera
écumoire



	Ø cm	→ cm		€
00602	11,5	Griff / handle 23		5,30

**Schöpflöffel**

ladle
cucharón
louche



	Ø cm	→ cm	ltr.	€
00606	9	Griff / handle 23	0,1	5,50

**Toastzange**

sandwich tong
pinza para sandwich
pince à toasts



	cm	→ cm		€
00601	11 x 8	Griff / handle 18		6,80

**Spaghettizange**

spoon
pinza espaguetis
pince universelle ou à spaghettis



	cm	→ cm		€
88637	9 x 9	Griff / handle 15		5,30

**Salatzange**

salad tong
pinza ensalada
pince à salade



	cm	→ cm		€
00605	10 x 6	Griff / handle 23		5,50

STOP-TOOLS

Die STOP-Funktion verhindert, dass Gabel oder Löffel in das Gefäß rutschen.

The smart STOP-function prevent forks and spoon not to slip into the vessel.

La función STOP evita que los cubiertos se caigan dentro del recipiente. Antideslizante.

La fonction STOP empêche les couverts de glisser dans le récipient.



Servierlöffel

serving spoon
cuchara de servicio
cuillère de service



Materialdicke 2,5 mm, ergonomischer, rutschfester Griff
ergonomic antislip handle
mango ergonómico antideslizante
manche ergonomique antidérapante

	cm	→ cm	€
00834	10 x 7,5	Griff / handle 17	9,90



Servierlöffel geschlitzt

slotted spoon
cuchara de servicio
cuillère de service



Materialdicke 2,5 mm, ergonomischer, rutschfester Griff
ergonomic antislip handle
cuchara de servicio ranurada
cuillère de service rainurée

	cm	→ cm	€
00833	10 x 7,5	Griff / handle 17	9,90



Schöpflöffel

ladle
cucharón
louche



Materialdicke 2,5 mm, ergonomischer, rutschfester Griff
ergonomic antislip handle
mango ergonómico antideslizante
manche ergonomique antidérapante

	Ø cm	→ cm	€
00832	9	Griff / handle 17	10,40



Fleischgabel

meat fork
tenedor de carne
fourchette à viande



Materialdicke 2,5 mm, ergonomischer, rutschfester Griff
ergonomic antislip handle
mango ergonómico antideslizante
manche ergonomique antidérapante

	cm	→ cm	€
00831	10,5 x 4	Griff / handle 17	9,90



Servierlöffel geschlitzt
 serving spoon
 cuchara de servicio ranurada
 cuillère de service rainurée



ergonomischer, rutschfester Griff
 ergonomic antislip handle
 mango ergonómico antideslizante
 manche ergonomique antidérapante

	cm	→ cm	€
00664	11 x 7	Griff / handle 25	6,00



Servierlöffel
 serving spoon
 cuchara de servicio
 cuillère de service



ergonomischer, rutschfester Griff
 ergonomic antislip handle
 mango ergonómico antideslizante
 manche ergonomique antidérapante

	cm	→ cm	€
00662	11 x 7	Griff / handle 25	6,00



Schöpföffel
 ladle
 cucharón
 louche



ergonomischer, rutschfester Griff
 ergonomic antislip handle
 mango ergonómico antideslizante
 manche ergonomique antidérapante

	cm	→ cm	ltr.	€
00670	9 x 8	Griff / handle 25	0,10	6,60



Wender
 slotted turner
 espátula para plancha
 spatule pour le grill



ergonomischer, rutschfester Griff
 ergonomic antislip handle
 mango ergonómico antideslizante
 manche ergonomique antidérapante

	cm	→ cm	€
00668	10 x 8	Griff / handle 25	6,60



Fleischgabel
 meat fork
 tenedor de carne
 fourchette à viande



ergonomischer, rutschfester Griff
 ergonomic antislip handle
 mango ergonómico antideslizante
 manche ergonomique antidérapante

	cm	→ cm	€
00666	10 x 3,5	Griff / handle 25	6,00



Schöpflöffel „PROFI“

ladle
cacillo
louche



	∅ cm	→ cm	ltr.	€
00711	6	Griff / handle 28	0,050	11,40
00712	7	Griff / handle 30	0,080	11,80
00713	8	Griff / handle 32	0,125	12,80
00714	9	Griff / handle 33	0,150	14,60
00715	10	Griff / handle 35	0,250	15,40
00716	11	Griff / handle 36	0,300	16,00



Schaumlöffel „PROFI“

skimmer
espumadera
écumoire



	∅ cm	→ cm	€
00721	10	Griff / handle 34	12,40
00722	12	Griff / handle 37	13,30
00723	14	Griff / handle 40	14,40



Wender „PROFI“

turner
espátula
spatule



	cm	→ cm	€
00730	10 x 11,5	Griff / handle 38	14,40



Servierlöffel „PROFI“

serving spoon
cuchara de servicio
cuillère de service



	cm	→ cm	€
00671	11 x 7	Griff / handle 29	geschlitzt / slotted 8,60
00672	11 x 7	Griff / handle 29	8,60



Spaghettilöffel „PROFI“

spaghetti spoon
cuchara de espaguetis
cuillère à spaghettis



	cm	→ cm	€
00673	10 x 7	Griff / handle 29	9,30

**Servierlöffel „CLASSIC“**

serving spoon
cuchara de servicio
cuillère de service



hochglanzpoliert, perforiert, Löcher Ø 4 mm, ergonomisch profilierter Hohl-Griff
mirror polished finish, perforated, holes Ø 4 mm, ergonomic designed handle
pulido brillante agujeros de Ø 4 mm, asa ergonómica
brillant, trous Ø 4 mm, manche ergonomique

	cm	→ cm	€
75903	9,5 x 7	Griff / handle 23,5	8,50

**Servierlöffel „CLASSIC“**

serving spoon
cuchara de servicio
cuillère de service



hochglanzpoliert, ergonomisch profilierter Hohl-Griff
mirror polished finish, ergonomic designed handle
pulido brillante, asa ergonómica
brillant, manche ergonomique

	cm	→ cm	€
75904	9,5 x 7	Griff / handle 23,5	8,20

**Schaumlöffel „CLASSIC“**

skimmer
espumadera
écumoire



hochglanzpoliert, ergonomisch profilierter Hohl-Griff
mirror polished finish, ergonomic designed handle
pulido acabado brillante, mango ergonómico
brillant, manche ergonomique

	Ø cm	→ cm	€
75911	11	Griff / handle 26	8,50

**Pfannenwender geschlitzt „CLASSIC“**

turner
espátula ranurada
spatule rainurée



	cm	→ cm	€
75910	9 x 8	Griff / handle 21	8,50

**Tranchiergabel „CLASSIC“**

fork
tenedor para carne
fouchette à viande



hochglanzpoliert, ergonomisch profilierter Hohl-Griff, Zinkenlänge 8 cm
mirror polished finish, ergonomic designed handle, length of prongs 8 cm
pulido brillante, asa ergonómica, largo de las puas 8 cm
brillant, manche ergonomique, dents long. 8 cm

	cm	→ cm	€
75905	8,5 x 2,5	Griff / handle 20,5	7,60



Salatlöffel „CLASSIC“

salad spoon
cuchara para ensalada
cuillère à salade



hochglanzpoliert, ergonomisch profilierter Hohl-Griff
mirror polished finish, ergonomic designed handle
inox brillante, asa ergonómica
brillant, manche ergonomique

	cm	→ cm	€
75902	8 x 6	Griff / handle 21,5	8,50



Salatgabel „CLASSIC“

salad fork
tenedor de servicio para ensalada
fourchette de service pour la salade



hochglanzpoliert, ergonomisch profilierter Hohl-Griff
mirror polished finish, ergonomic designed handle
pulido brillante, asa ergonómica
brillant, manche ergonomique

	cm	→ cm	€
75901	8 x 6	Griff / handle 21,5	8,70



60 ml

Suppenkelle „CLASSIC“

soup ladle
cucharón de sopa
louche de service



hochglanzpoliert, ergonomisch profilierter Hohl-Griff
mirror polished finish, ergonomic designed handle
pulido brillante, asa ergonómica
brillant, manche ergonomique

	Ø cm	→ cm	ltr.	€
75907	7	Griff / handle 23	0,06	9,30



100 ml

Suppenkelle „CLASSIC“

soup ladle
cucharón de sopa
louche de service



hochglanzpoliert, ergonomisch profilierter Hohl-Griff
mirror polished finish, ergonomic designed handle
pulido brillante, asa ergonómica
brillant, manche ergonomique

	Ø cm	→ cm	ltr.	€
75908	9	Griff / handle 24	0,1	9,60

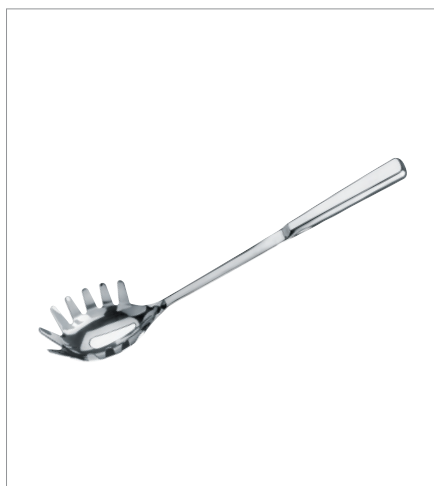

Spaghettiheber „CLASSIC“

spaghetti server
tenedor espaguetis
cuillère à spagettis



hochglanzpoliert, ergonomisch profilierter Hohl-Griff
mirror polished finish, ergonomic designed handle
acabado brillante, asa ergonómica
brillant, manche ergonomique

	cm	→ cm	€
75909	8 x 6,5	Griff / handle 22,5	9,10

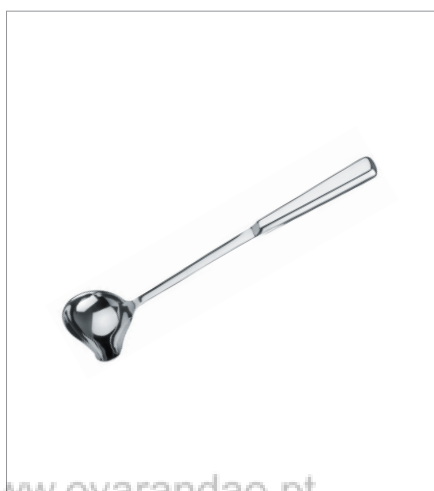

Saucengießlöffel „CLASSIC“

sauce / gravy ladle
cucharón de salsa
cuillère à sauce



hochglanzpoliert, ergonomisch profilierter Hohl-Griff, fugenlos
mirror polished finish, ergonomic designed handle, seamless
pulido brillante, asa ergonómica, sin soldadura
brillant, manche ergonomique, monobloc (sans soudure)

	cm	→ cm	ltr.	€
75906	7 x 5,5	Griff / handle 22	0,02	8,00



Tortenmesser „CLASSIC“

cake knife
porcionador de pastel
couteau à tarte



eine Kante gezahnt 15,5 cm
one edge serrated 15,5 cm
un borde serrado de 15,5 cm
denté sur un côté à 15,5 cm

	cm	→ cm	€
75912	5 x 1	Griff / handle 12	9,30



Tortenheber „CLASSIC“

cake lifter
pala de tartas
pelle à gâteau



hochglanzpoliert, mit einer gezahnten Kante, ergonomisch profilierter Hohl-Griff
mirror polished finish, one edge serrated, ergonomic designed handle
pulido brillante, canto dentado, mango ergonómico
brillant, bord microdenté, manche ergonomique

	cm	→ cm	€
75900	8 x 5	Griff / handle 10,5	7,60

BANQUET



Die Vorlegeserie BANQUET ist die passende Ergänzung zum Servieren am Buffet. Durch die mattierte Oberfläche und das gebogene Griffende wird BANQUET praktischen und optischen Ansprüchen gerecht.

The series BANQUET is the perfect addition for serving at the buffet. Due to the matt surface and the curved handle, BANQUET meets practical and optical requirements.

La serie BANQUET es la adición perfecta para servir en el buffet. Debido a la superficie mate y al mango curvado, BANQUET cumple con requisitos prácticos y ópticos.

La série BANQUET est l'ajout parfait pour servir au buffet. Grâce à la surface mate et la poignée incurvée, BANQUET répond aux exigences pratiques et optiques.

www.ovarandao.pt



www.ovarandao.pt

Salat- / Servierlöffel „BANQUET“

salad spoon / serving spoon
cuchara para ensalade / cuchara de servicio
cuillère à salade / cuillère de service



	cm	→ cm	€
00588	6 x 5	Griff / handle 17	4,80
00590	7,5 x 6	Griff / handle 21	7,00

www.ovarandao.pt

www.ovarandao.pt



www.ovarandao.pt

Salatgabel „BANQUET“

salad fork
tenedor de servicio para ensalada
fourchette de service pour la salade



	cm	→ cm	€
00589	6 x 5	Griff / handle 17	4,80
00591	7,5 x 6	Griff / handle 21	7,00

www.ovarandao.pt

www.ovarandao.pt



www.ovarandao.pt

Pfannenwender „BANQUET“

turner
espátula
spatule



	cm	→ cm	€
00587	10 x 7,5	Griff / handle 21	7,90

www.ovarandao.pt

**Chafing Dish Löffel „BANQUET“**

serving spoon
cuchara para servir
cuillère de service



	cm	→ cm	€
00592	11 x 6,5	Griff / handle 24	8,20
00593	11 x 6,5	Griff / handle 24 geschlitzt / slotted	7,90

**Dressinglöffel „BANQUET“**

dressing spoon
cuchara de aliño
cuillère à vinaigrette



	cm	→ cm	€
00594	6 x 4	Griff / handle 30	9,90

**Schöpflöffel „BANQUET“**

ladle
cucharón
louche



	cm	→ cm	€
00595	8,5 x 7,5	Griff / handle 24	12,90

**Fleischgabel „BANQUET“**

meat fork
tenedor de carne
fourchette à viande



	cm	→ cm	€
00596	8 x 2,5	Griff / handle 13	4,20

**Serviergabel „BANQUET“**

fork
tenedor de servicio
fourchette de service



	cm	→ cm	€
00597	9 x 4	Griff / handle 21	7,20

**Tortenheber „BANQUET“**

cake lifter
pala de tartas
pelle à gâteau



eine Kante gezahnt
one edge serrated
un borde serrado
denté sur un côté

	cm	→ cm	€
00598	14 x 6	Griff / handle 13	6,20



NEW

Universalzange

all - purpose tong
pinza universal
pince universelle

hochglanzpoliert
mirror polished finish
acabado brillante
brillant



	cm	→ cm		€
75830	7 x 5	25		10,00



NEW

Universalzange

all - purpose tong
pinza universal
pince universelle

hochglanzpoliert, Gold-Look
mirror polished finish, gold-look
pulido brillante, dorado
poli brillant, doré



	cm	→ cm	Farbe / Colour	€
75831	7 x 5	25	gold-look	12,00



NEW

Universalzange

all - purpose tong
pinza universal
pince universelle

hochglanzpoliert, Kupfer-Look
mirror polished finish, copper-look
pulido brillante, cobre
poli brillant, cuivre



	cm	→ cm	Farbe / Colour	€
75832	7 x 5	25	copper-look	12,00



Salatzange

salad tong
pinza ensalada
pince à salade

hochglanzpoliert, beidseitig geschlitzt
mirror polished finish, slotted on both side
acabado brillante, agujereada en 2 lados
brillant, perforéedes 2 côtés



	cm	→ cm		€
75801	5 x 2	24		5,80



Spaghettizange

spaghetti tong
pinza espaguetis
pince à spaghettis

hochglanzpoliert, fugenlos
mirror polished finish, seamless
acabado brillante, sin soldaduras
brillant, monobloc



	cm	→ cm		€
75810	6 x 3	19		4,30

**Pinzettenzange**

fine tong / tweezer
pinza de emplatar
pince à dresser



hochglanzpoliert, geriffelte Grifffläche, schwere Qualität
mirror polished finish, ribbed handle, heavy gauge
acabado brillante, mango cómodo ranurado, alta calidad
brillant, manche rainuré antiglisse, qualité extra

..... → cm €
75820 16 6,00

**Pinzettenzange**

fine tong / tweezer
pinza de emplatar
pince à dresser



hochglanzpoliert, geriffelte Grifffläche, schwere Qualität
mirror polished finish, ribbed handle, heavy gauge
acabado brillante, mango cómodo ranurado, alta calidad
brillant, manche rainuré antiglisse, qualité extra

..... → cm €
75821 30 9,00

**Pinzettenzange**

fine tong / tweezer
pinza de emplatar
pince à dresser



hochglanzpoliert, geriffelte Grifffläche, schwere Qualität
mirror polished finish, ribbed handle, heavy gauge
acabado brillante, mango cómodo ranurado, alta calidad
brillant, manche rainuré antiglisse, qualité extra

..... → cm €
75809 30 7,80

**Pinzettenzange**

fine tong / tweezer
pinza de emplatar
pince à dresser



hochglanzpoliert, geriffelte Grifffläche, abgerundete Spitzen vorne, schwere Qualität
mirror polished finish, ribbed handle, rounded on the tops, heavy gauge
acabado brillante, mango cómodo ranurado, alta calidad, puntas redondeadas
brillant, manche rainuré antiglisse, qualité extra, pointes arrondies

..... → cm €
75808 14,5 5,00



Salatzange
 salad serving tong
 pinza de ensalada
 pince à servir la salade



hochglanzpoliert, einfache Handhabung
 mirror polished finish, convenient handling
 pulido brillante, manejo cómodo
 brillant, manipulation aisée

	cm	→ cm	€
00685	7,0 x 4,5	25	15,00



Universalzange
 all - purpose tong
 pinzas multiusos
 pince multi-usages



hochglanzpoliert, einfache Handhabung
 mirror polished finish, convenient handling
 pulido brillante, manejo cómodo
 brillant, manipulation aisée

	cm	→ cm	€
00688	7,0 x 4,5	25	15,00



Brot- und Gebäckzange
 bread and pastry tong
 pinza para pan y bollería
 pince à pain ou viennoiseries



hochglanzpoliert, einfache Handhabung
 mirror polished finish, convenient handling
 pulido brillante, manejo cómodo
 brillant, manipulation aisée

	cm	→ cm	€
00686	7,0 x 4,5	25	15,00



Brot- und Gebäckzange
 bread and pastry tong
 pinza para pan y bollería
 pince à pain ou viennoiseries



hochglanzpoliert, einfache Handhabung
 mirror polished finish, convenient handling
 pulido brillante, manejo cómodo
 brillant, manipulation aisée

	cm	→ cm	€
00687	7,0 x 4,5	25	15,00

**Allzweckzange**

multipurpose tong
pinza multi-usos
pince universelle multi-usages



hochglänzend, mit Feder und Verschlusschieber, dekorative Greiferform
high-gloss finish, with spring and retaining clip, decorative gripper form
pulido brillante, con muelle y cierre deslizante, gancho con forma decorativa
finition brillante, avec mécanisme de verrouillage, forme de pince décorative

	cm	→ cm	€
88643	4 x 3	24	2,90
88644	4 x 3	30	3,60
88645	4 x 3	40	3,90

**Aufschnitt- / Allzweckzange**

sausage tong
pinza salchichas
pince à saucisses



hochglanzpoliert, fugenlos
mirror polished finish, seamless
pulido brillante, sin soldadura
brillant, monobloc

	cm	→ cm	€
75806	3 x 2,5	16	3,60

**Gebäckzange**

pastry tong
pinza para pasteles
pince à gâteaux



hochglanzpoliert, fugenlos, extra schwere Qualität
mirror polished finish, seamless, extra heavy gauge
pulido brillante, sin soldadura, alta calidad, resistente
brillant, monobloc, qualité extra, robuste

	cm	→ cm	€
75807	8,5 x 4	27,5	8,90

**Universalzange**

all - purpose tong
pinza universal
pince universelle



hochglanzpoliert, einseitig geschlitzt
mirror polished finish, slotted on one side
acabado brillante, agujereada en un lado
brillant, perforée d'un seul côté

	cm	→ cm	€
75800	5 x 2	24	4,50

**Gebäckzange**

pastry tong
pinza para pasteles
pince à gâteaux

hochglanzpoliert, perforiert
mirror polished finish, perforated
pulido brillante, perforado
brillant, perforée



	cm	→ cm	€
75804	6,5 x 3	19,5	7,80

**Gebäck- / Tortenzange**

pastry tong
pinza para pasteles
pince à gâteaux

hochglanzpoliert, fugenlos
mirror polished finish, seamless
acabado brillante, sin soldadura
brillant, monobloc



	cm	→ cm	€
75803	7 x 3,5	17,5	4,90

**Eisportionierer**

ice cream scoop
cuchara para helado
cuillère à glace

hochglanzpoliert, mit Edelstahlfeder (physikalisch bedingt nicht korrosionsbeständig)
mirror polished finish, spring steel, spring is not stainless
pulido brillante, muelle de acero especial, no resistente al óxido
poli brillant, ressort acier spécial, non résistant à l'oxydation



	Ø cm	→ cm	ltr.	€
71006	6,5	23,5	1/12	11,00
71005	6,0	22,5	1/16	11,00
71004	5,5	22,0	1/20	11,00
71003	5,0	22,0	1/24	11,00
71002	5,0	21,5	1/30	11,00
71001	4,5	21,0	1/36	11,00

**Messlöffelsatz**

set measuring spoon
juego de cucharas medidoras
jeu de cuillère à mesure

Löffel hochglanzpoliert, Stiele matt poliert, Skalierung:
1 Esslöffel, 1 Teelöffel, 1/2 Teelöffel, 1/4 Teelöffel

bowl mirror polished finish, handles satin polished finish, measures:
table spoon, tea spoon, 1/2 tea spoon, 1/4 tea spoon

bol medidor brillante, mango mate medidas:

1 cuchara de sopa, 1 cuchara de té, 1/2 cuchara de té, 1/4 cuchara de té

corps brillant, manche mat, mesures:

1 cuillerée à soupe, 1 cuillerée à thé, 1/2 cuillère à thé, 1/4 de cuillère à thé



	cm	€
75600	14 x 4,5	6,00



Feinkostlöffel, 6er Set
 delicatessen spoon, 6 pcs. set
 cuchara gourmet, set de 6
 cuillère gourmet, set de 6



	∅ cm	→ cm	pcs.	Farbe / Colour	€
88627	6	23	6	White	8,50



Feinkostlöffel, 6er Set
 delicatessen spoon, 6 pcs. set
 cuchara gourmet, set de 6
 cuillère gourmet, set de 6



	∅ cm	→ cm	pcs.	Farbe / Colour	€
88628	6	23	6	Black	8,50



Feinkostlöffel, 6er Set
 delicatessen spoon, 6 pcs. set
 cuchara gourmet, set de 6
 cuillère gourmet, set de 6



	∅ cm	→ cm	pcs.	Farbe / Colour	€
88626	6	23	6	Light Blue	8,20



Feinkost- / Olivenlöffel, 6er Set
 delicatessen / olives spoon, 6 pcs. set
 cuchara gourmet / para aceitunas, set de 6
 cuillère gourmet / à olives, set de 6



geloct
 perforated
 perforadas
 perforées

	cm	→ cm	pcs.	Farbe / Colour	€
88598	6 x 9	27	6	Black	10,00



Dressinglöffel
 dressing spoon
 cuchara de aliño
 cuillère à sauce



aus Kunststoff
 plastic
 plástico
 plastique

	∅ cm	→ cm	ltr.	Farbe / Colour	€
88636	6	34	0,05	White	3,30
88609	6	34	0,05	Black	3,30

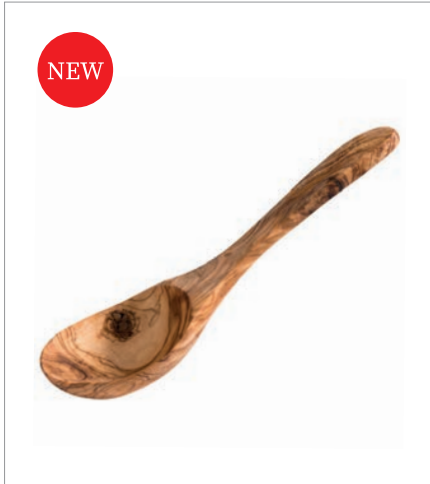

Löffel

spoon
cuchara
cuillère



aus Olivenholz, ideal für Reis, Gemüse...
olive wood, ideal for rice, vegetables...
madera de olivo, ideal para arroz, verduras...
en bois d'olivier, idéal pour le riz, les legumes...

	cm	→ cm	€
00840	9,5 x 8,5	17,0	14,90



Salatbesteck, 2er Set

spoon, 2 pcs. set
cuchara, set de 2
cuillère, set de 2



aus Olivenholz
olive wood
madera de olivo
en bois d'olivier

	cm	→ cm	€
00841	9,5 x 8,5	17,0	10,00

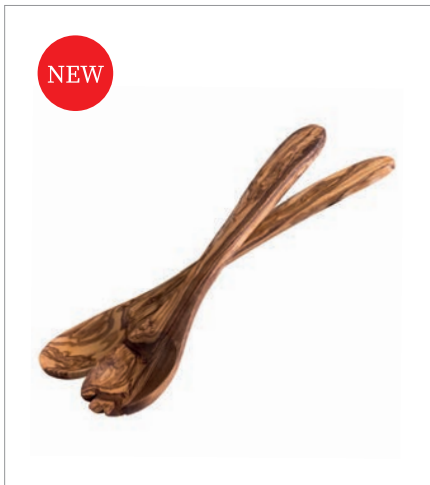

Salatbesteck, 2er Set

spoon, 2 pcs. set
cuchara, set de 2
cuillère, set de 2



aus Olivenholz
olive wood
madera de olivo
en bois d'olivier

	cm	→ cm	€
00842	7,5 x 6,0	22,5	16,00



Löffel

spoon
cuchara
cuillère



aus Akazienholz, ideal für Reis, Gemüse...
acacia wood, ideal for rice, vegetables...
madera de acacia, ideal para arroz, verduras...
bois d'acacia, idéal pour le riz, les legumes...

	cm	→ cm	€
00599	9 x 6,5	23,5	4,90

**Kugelausstecher - doppelt „ORANGE“**

melon baller - double
vaciador doble de bola
moule à boule double



zum Formen von Kugeln aus Obst, Gemüse oder Butter, Edelstahl mit geschärften Rändern
to form balls out of fruits, vegetables, butter, etc., stainless steel with sharpened edge
para hacer bolas con frutas, verduras, mantequilla, etc. acero inoxidable con borde afilado
pour faire des boules de fruits, légumes, beurre, etc. inox, bord affûté

	∅ cm	→ cm	€
88810	2,2 + 2,5	16,5	6,20
88811	2,2 + 3,0	17	6,30

**Fadenschneider / Zester „ORANGE“**

decorator / zester
cuchillo de decoración cincelador
couteau zesteur



zum Abziehen von feinsten Schalenstreifen, ideal zum Dekorieren von Torten und Desserts
to peel off very fine stripes of paring, these stripes are ideal to decorate desserts, cakes, etc.
para pelar tiras muy finas, ideal para decorar postres, tartas, etc.
pour couper en lanières fines, idéal pour la décoration de gâteaux et desserts, etc.

	∅ cm	→ cm	€
88823	0,2 + 0,5	14,5	3,50

**Ziseliermesser „ORANGE“**

canele / decorating knife
cuchillo de decoración cincelador acanalado
couteau zesteur cannelé



zum Einritzen von Linien und Mustern in hartschaliges Obst und Gemüse, Edelstahl mit geschärften Rändern
to score lines or design in hard fruits and vegetables, stainless steel with sharpened edge
para dibujar líneas en frutas o verduras de piel dura, acero inoxidable con borde afilado
pour découper des lignes et motifs sur fruits et légumes à peau dure ou pour peler les zestes des citrons ou oranges, inox, bord affûté

	→ cm	€
88826	15	3,50

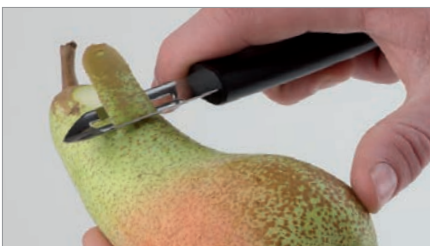
**Sparschäler „ORANGE“**

peeler
pelador
peleur



für Links- und Rechtshänder geeignet, mit zwei starren Klingen aus extra geschärftem + gehärtetem Edelstahl

useable left- and right handed, with 2 inflexible blades made out off sharpened, extra hardened stainless steel

para diestros y zurdos, con 2 cuchillas rígidas inox afiladas y muy resistentes

pour gauchers ou droitiers, 2 lames rigides affûtées en inox extra-résistant

	→ cm	€
88827	17	2,30

**Pendelschäler „ORANGE“**

swivel peeler
pelador reversible
éplucheur droitier/gaucher



für Links- und Rechtshänder, ideal für das Schälen von Tomaten, mit 2 beweglichen Klingen
suitable for right and left handed, ideal to peel tomatoes, with 2 flexibles blades
apto para diestros y zurdos, ideal para pelar tomates, con 2 hojas flexibles
pour gauchers ou droitiers, idéal pour peler les tomates, 2 lames flexibles

	→ cm	€
88850	16,5	3,70

**Cocktailmesser**

bar knife
cuchillo para cóctel
couteau cocktail



mit 2 Zinken zum Aufspießen von Zitrusseiben
with 2 prongs to pick up slices of lemon
con 2 dientes para pinchar las rodajas de limón, etc.
avec 2 dents pour les rondelles de citron et autres décorations

	→ cm	€
88846	21	3,80

**Pizzateigschneider „ORANGE“**

pizza cutter
cortador de pizza
roulette à pizza



zum einfachen Zerteilen von Pizza
to cut pizza easily
para cortar pizza fácilmente
pour une coupe facile de la pizza

	∅ cm	→ cm	€
88829	6	18,5	4,10

**Pendelschäler „ORANGE“**

swivel peeler
pelador lama pivotante
peleur lame pivotante



zum schnellen und sparsamen Schälen von Obst und Gemüse, mit beweglicher Klinge
to peel fruits and vegetables with flexible blade
para pelar frutas y verduras con hoja flexible
pour couper des fruits et légumes avec lame flexible

	→ cm	€
88834	17	4,30

**Apfelentkerner „ORANGE“**

apple corer
descorazonador de manzana
vide-pomme



durch leichtes Drehen kann das Kerngehäuse von Äpfeln, Birnen und anderen Früchten sorgsam herausgeholt werden, Edelstahl mit geschärften Rändern
with a light turn cores of apples, pears and other fruits can be cut off easily, stainless steel with sharpened edge
para descorazonar muy fácilmente manzanas, peras y otras frutas
pour évider facilement les pommes, poires ou autres fruits

	∅ cm	→ cm	€
88836	2,2	21	2,70



Austernöffner „ORANGE“

oyster knife
abre ostras
couteau à huîtres



zum einfachen Aufbrechen von Austern, mit Fingerschutz, Edelstahl mit geschärften Rändern
to open oysters easily, with guard, stainless steel with sharpened edge
para abrir ostras fácilmente con protección para los dedos, acero inoxidable con punta afilada
pour ouvrir facilement les huîtres avec protection pour les doigts, inox, pointe affûtée

→ cm €
88839 14,5 6,00



Austernmesser „ORANGE“

oyster knife
abre ostras
couteau à huîtres



Edelstahl-Klinge zum Einstechen in die Schale, mit Fingerschutz
to open oysters easily, with guard
para abrir ostras fácilmente con protección para los dedos
pour ouvrir facilement les huîtres avec protection pour les doigts

→ cm €
88840 15 3,40



Dekoriermesser „ORANGE“

decorating knife „canalé“
cuchillo acanalador
couteau cannelé



gezahnte Klinge aus geschärftem Edelstahl
serrated sharpened blade, stainless steel
hoja de sierra afilada, acero inoxidable
lame inox microdentée

→ cm €
88843 19 4,90



Käsehobel „ORANGE“

cheese slicer
rebanador de queso
couteau tranche-fromage



zum Schneiden von dünnen Käsescheiben
to cut thin slices of cheese
para cortar lonchas finas de queso
pour couper de fines tranches de fromage

→ cm €
88853 21,5 4,90



Streichpalette „BLUE“

spatula
espátula
spatule



flexible Edelstahl-Klinge, rutschfester Griff, hitzebeständig
flexible blade stainless steel, non-slip handle, heat-resistant
hoja flexible acero inoxidable mango polipropileno termoresistente anti-deslizante
lame inox flexible, manche antiglisse en polypropilène thermorésistant

	cm	→ cm	€
88920	35 x 5	48,5	8,20
88921	30,5 x 4,5	43,5	7,20
88922	25 x 4	38,0	6,60
88923	20 x 3	33,5	5,60



Winkelpalette „BLUE“

spatula
espátula
spatule



flexible Edelstahl-Klinge
flexible blade stainless steel
hoja flexible acero inoxidable
lame inox flexible

	cm	→ cm	€
88928	17 x 5	30	5,90



Gebäckpalette „BLUE“

pastry spatula
paleta pastelera
spatule pâtissière



flexible Edelstahl-Klinge
flexible blade stainless steel
hoja flexible acero inoxidable
lame inox flexible

	cm	→ cm	€
88932	17 x 7,5	29,5	6,40



Wender „BLUE“

turner
espátula
spatule



flexible Edelstahl-Klinge
flexible blade stainless steel
hoja flexible acero inoxidable
lame inox flexible

	cm	→ cm	€
88933	15 x 6	27,5	5,20



Winkelpalette „BLUE“

turner
espátula
spatule



flexible Edelstahl-Klinge
flexible blade stainless steel
hoja flexible acero inoxidable
lame inox flexible

	cm	→ cm	€
88935	34 x 5	47,5	8,40
88937	24 x 4	36	6,20
88938	18,5 x 3	32	5,50



Wender „BLUE“

turner
espátula
spatule



flexible Edelstahl-Klinge
flexible blade stainless steel
hoja flexible acero inoxidable
lame inox flexible

	cm	→ cm	€
88939	24 x 7,5	37,5	7,90



Wender „BLUE“

turner
espátula
spatule



perforiert, flexible Edelstahl-Klinge
perforated, flexible blade stainless steel
hoja flexible inox agujereada
lame ajourée inox flexible

	cm	→ cm	€
88940	24,5 x 7,5	37,5	8,20



Wender „BLUE“

turner
espátula para plancha
spatule



flexible Edelstahl-Klinge
flexible blade stainless steel
hoja flexible acero inoxidable
lame inox flexible

	cm	→ cm	€
88941	20 x 7,5	33	7,00
88942	15 x 9	28	6,90



Spachtel / Schaber „BLUE“

scraper
espátula plancha
spatule coudée spéciale grill

starre Edelstahl-Klinge
rigid blade stainless steel
hoja rígida acero inoxidable
lame inox rigide



	cm	→ cm	€
88929	11 x 10	25	6,50



Spachtel / Fettabstecher „BLUE“

scraper
espátula plancha
spatule coudée spéciale grill

starre Edelstahl-Klinge
rigid blade stainless steel
hoja rígida de acero inoxidable
lame rigide inox



	cm	→ cm	€
88946	17 x 10	30	7,90
88947	15 x 7,5	28	6,50

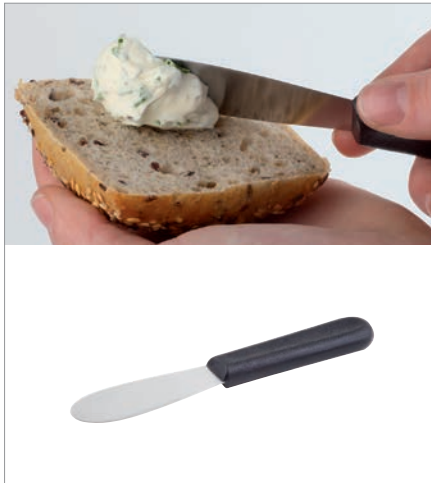

Aufstrichmesser „BLUE“

sandwich knife
cuchillo para untar
couteau à tartiner

flexible Edelstahl-Klinge
flexible blade stainless steel
hoja flexible acero inoxidable
lame inox flexible



	cm	→ cm	€
88948	8,5 x 3	18,5	2,40



Teigschaber / Abstecher „BLUE“

dough scraper
corta pasta
coupe-pâte

starre Edelstahl-Klinge
rigid blade stainless steel
hoja rígida de acero inoxidable
lame rigide inox



	cm	€
88930	15,5 x 8	4,40

**Wender „PRO“**

turner
espátula
spatule

flexible Edelstahl-Klinge
flexible blade stainless steel
hoja inox flexible
lame inox flexible



	cm	→ cm	€
88701	12 x 8,7	29	12,00

**Pizzaschneider „BLUE“**

pizza cutter
cortador de pizza
coupe-pizza

ergonomischer Griff
ergonomic handle
mango ergonómico
manche ergonomique



	Ø cm	→ cm	€
88949	10	20	5,80

**Pizzaschneider „PRO“**

pizza cutter
cortador de pizza
coupe-pizza

ergonomischer Griff
ergonomic handle
mango ergonómico
manche ergonomique



	Ø cm	→ cm	€
88727	10	25	9,60

**Pizzaschaufel**

pizza peel
pala de pizza
pelle à pizza



	cm	→ cm	€
88080	35 x 30,5	90	34,00
88081	35 x 30,5	130	41,00



Eierschneider

egg cutter
corta huevos
coupe-oeufs



zum Längs- und Querteilen von hart gekochten Eiern

to cut hard-boiled eggs
corta a rodajas un huevo duro
en rondelles

	cm	↑ cm	€
88099	14,5 x 8	2,5	2,20



Hummerbrecher

lobster cracker
pinza bogavante
pince à homard



	cm	€
74201	14 x 5,5	7,00

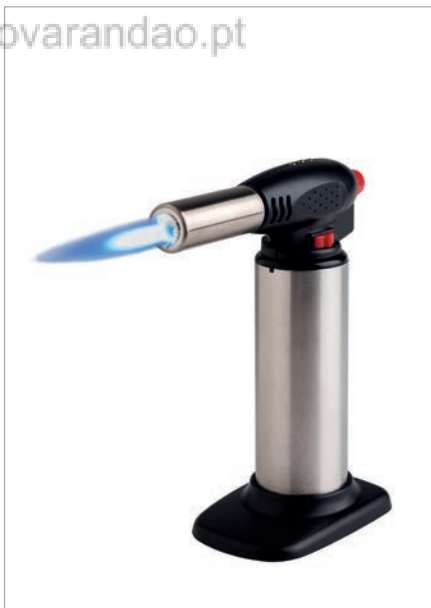

Flambierbrenner

chefs blow torch
soplete de cocina para flambear
chalumeau de cuisine



mit handelsüblichem Feuerzeuggas auffüllbar, Flamme einstellbar bis ca. 1300° C, Brenndauer von min. 60 Minuten

to be filled with commercial lighter gas, flame adjustable up to approx. 1300° C, burning time of at least 60 minutes

rellenable con gas de mechero comercial, llama ajustable hasta 1300° C, tiempo de combustión de al menos 60 minutos

rempli avec gaz pour briquet commercial, flamme réglable jusqu'à 1300° C, temps de combustion d'au moins 60 minutes

	Ø cm	↑ cm	€
77315	4,5	16,5	29,00



Rezeptionsglocke

ring bell
timbre
sonnette



	Ø cm	↑ cm	Farbe / Colour	€
71400	8,5	6,0	■	4,90
71433	10,0	6,5	■	7,20

71400

**Schneebesens**whisk
batidor
fouet

	Drähte / wires	→ cm	€
00744	8	28	6,60
00745	8	33	6,60
00746	8	38	8,50
00747	8	43	9,70
00740	8	48	10,00

**Passiersieb**strainer
colador
passoirefeines Siebgewebe mit ca. 6 Löchern pro 1 cm²fine mesh with 6 holes per 1 cm²malla fina con 6 agujeros por 1 cm²toile fine avec 6 trous pour 1 cm²

	Ø cm	↑ cm	Stiellänge → cm	€
88617	26	12	28	44,00
88618	30	17	28	54,00

**Passiersieb**strainer
colador
passoirefeines Siebgewebe mit ca. 6 Löchern pro 1 cm²fine mesh with 6 holes per 1 cm²malla fina con 6 agujeros por 1 cm²toile fine avec 6 trous pour 1 cm²

	Ø cm	↑ cm	Stiellänge → cm	€
74700	14	5,0	16	7,60
74701	16	6,0	16	9,80
74702	18	7,5	16	13,20
74703	20	8,5	16	14,40
74705	24	11,0	17	16,50
74706	26	11,0	17	19,60

**Passiersieb**strainer
colador
passoire

mit Doppelnetz, Netz außen: ca. 2 Löcher pro 1 cm, Netz innen: ca. 5 Löcher pro 1 cm

with double mesh, outer mesh about 2 holes per cm, inner mesh about 5 holes per cm

con malla doble, malla exterior aprox. 2 agujeros /cm, interior aprox. 5 agujeros /cm

avec double étamine, extérieure env. 2 trous/cm, intérieure environ 5 trous/cm

	Ø cm	↑ cm	Stiellänge → cm	€
74721	20	8	18	13,00
74722	24	10	28	20,00

**Back- / Frittierlöffel**

skimmer / spider
espumadera para fritos
écumoire à friture

elektropoliert, sehr stabile Ausführung

electro polished, heavy gauge

electro pulido, alta calidad

poli électrolythique, qualité extra



	Ø cm	→ cm	€
74402	16	33,5	17,00
74404	20	33,5	21,00

**Pommes-Frites-Seiher**

fry dripping tray
escurridor de fritos
égouttoir à friture

herausnehmbarer Locheinsatz, mit Handgriff

removable drainer, with handle

fondo de colador desmontable, con asa

fond démontable, avec poignée



	Ø cm	↑ cm	€
00785	39	19	28,00

**Salzstreuer**

salt shaker
salero
salière

Pommes-Frites Streuer mit Schraubkappe

for french fries, cover to screw

para patatas fritas, tapa de rosca

pour les frites, couvercle à visser



	Ø cm	↑ cm		€
00772	8	17	stainless steel	11,40
00779	8	17	aluminium	8,90

**Gazespitzsieb**

conical strainer with wire gauze
colador chino de malla
chinois renforcé avec maille fine

hochglanzpoliert, mit rundem Hohlgriff, ca. 9 Löcher pro 1 cm²

mirror polished finish, 9 holes per 1 cm²

pulido acabado brillante, mango hueco, 9 agujeros por 1 cm²

brillant, manche creux, 9 trous pour 1 cm²



	Ø cm	↑ cm	→ cm	€
88718	20	15	24	35,30
88717	24	19	24	42,60



Spitzsieb

conical strainer
colador cónico
chinois



mit Lochung Ø 1,5 mm, auch in der Kegelspitze, mit Flachstiel, mit Stützstiel zum Einhängen in den Topfrand

with Ø 1,5 mm holes (including the tip), with flat handle, with supporting hook
con agujeros finos de Ø 1,5 mm (incluida la punta), con mango plano y gancho
perforations fines 1,5 y compris à la pointe, manche plat et crochet

	Ø cm	↑ cm	→ cm	€
00771	23	18	16,5	23,00



Likör- und Fondantrichter

confectionery funnel
embudo dosificador
entonnoir à piston



ergonomischer Griff aus Kunststoff, mit 3 Düsen 2, 4, 6 mm, inkl. Ständer u. Auffangschale
ergonomic plastic handle, with 3 different nozzles 2, 4, 6 mm, incl. wire rack a. dripping dash
mango ergonómico con 3 boquillas, 2, 4, 6 mm, incl. pie de alambre y bandeja recoge gotas
manche plastique ergonomique, 3 douilles de 2, 4 et 6 mm, inclut pied avec ramasse-gouttes

	Ø cm	↑ cm	ltr.	€
77338	20	34	1,5	88,00



Gemüsehobel, Mandoline

mandolin
mandolina
mandoline



mit 7 verschiedenen Klingen (Breite 10 cm), Anti-Rutsch-Gestell, Schutzabdeckung
with 7 interchangeable blades (width 10 cm), non-slip folding stand, safety guard
con 7 cuchillas intercambiables (corte 10 cm), pie plegable anti-deslizante, carro de seguridad
7 peignes interchangeables (largeur 10 cm), pied repliable anti-glisse, chariot

	cm	↑ cm	€
88688	40,5 x 12	5 / 25	72,00



- A** 7 verschiedene Klingen
7 interchangeable blades
B Praktische Transportbox
Practical transport box



Wasserbadschüssel

bain marie bailing bowl
cazo para baño maría
réceptier bain-marie



hochglanzpoliert, mit Drahtgriff Ø 5 mm
mirror polished finish, with wire handle Ø 5 mm
inox pulido brillante, mango varilla Ø 5 mm
inox brillant, manche fil épaisseur Ø 5 mm

	Ø cm	↑ cm	→ cm	ltr.	€
74731	18	9	15	1,5	12,40

**Mess- / Universalkanne**

graduated jug
jarra medidora universal
pichet mesureur universel



matt poliert, mit Maßskalierung innen

satin polished finish, with stamped liter scale inner
acabado satinado, con graduación en el interior
mat, graduations à l'intérieur

	Ø cm	↑ cm	ltr.	€
30054	12	13	1	18,40
30055	14	17	2	32,00

**Messbecher**

graduated jug
jarra graduada
pichet gradué



außen hochglanzpoliert, innen matt poliert, mit Maßskalierung außen

outside mirror polished finish, inside satin polished finish, with stamped liter scale
exterior pulido brillante, interior satinado con escalado en litros
extérieur brillant, intérieur satiné, graduation en litres

	Ø cm	↑ cm	ltr.	€
30045	10	14	1	12,00

**Messbecher**

measuring cup
jarra graduada
pichet gradué



mit geschlossenem Griff, mit geprägter Maßskalierung außen, l- und ml-Liter-Einteilung
with handle, with stamped printed liter and ml scale
con asa, graduación ml.
avec anse, graduation en ml.

	Ø cm	↑ cm	ltr.	€
30046	9,5	14	0,5	2,90
30047	12	17	1	3,90
30048	15,5	21	2	6,90
30049	17,5	23,5	3	8,90
30057	20,5	27,5	5	10,50

**Schaumpeiseringe, 5er Set**

mousse ring, 5 pcs. set
juego aros para emplatar o para semifríos
jeu de cercles à mousse inox, ronds



5-teilig: 4 Formen + 1 Verdichter, matt poliert, fugenlos

5 pcs. set: 4 shapes and 1 pusher, satin polished finish, seamless
juego de 5 piezas: 4 aros redondos y 1 pulsador, para dar forma, satinado sin soldadura
jeu de 5 pièces: 4 cercles et 1 poussoir. Idéal pour dressage sur assiette ou mousse, mat satiné, sans soudure

	Ø cm	↑ cm	€
00110	6	4,5	16,00
00113	8	4,5	17,00



Schaumspeisering

mousse ring
aro redondo para semifríos
cercle à mousse rond

matt poliert, fugenlos
satin polished finish, seamless
acabado satinado sin soldadura
mat satiné, sans soudure



	Ø cm	↑ cm	€
00098	6	4,5	2,90
00099	7	4,5	3,20
00092	8	4,5	3,40
00093	10	4,5	4,70
00094	12	4,5	6,20



Dariolformen, 2er Set

daiquiri moulds, 2 pcs. set
juego 2 flaneras
jeu de 2 moules à flan

hochglanzpoliert
mirror polished finish
acabado brillante
brillant



	Ø cm	↑ cm	ltr.	€
00106	6,5	4,5	0,1	5,00



Tortenring

cake setting ring
aro de tarta
cercle à gâteaux

stufenlos verstellbar
adjustable
ajustables
ajustables



	Ø cm	↑ cm		€
00040	16,5 - 32	7	ohne Griff / without handle	7,80



Backform

baking pan
marco pastelero
forme à gateaux

stufenlos verstellbar, aus flexiblem Edelstahl
adjustable
ajustable
ajustable



	cm	↑ cm	€
00042	19 x 28 - 34 x 54	5	16,40



Tablett „VINTAGE“

tray
bandeja
plateau



Edelstahl-Look vintage
stainless steel vintage look
acero inoxidable look vintage
acier inox look vintage

	cm	↑ cm	€
30130	26,0 x 13,5	1,5	7,00
30131	34,0 x 18,0	1,5	12,00
30132	38,0 x 26,5	1,5	19,00
30133	25,5 x 16,0	3,0	14,00



Ausstellblech / Thekenblech

display tray
bandeja pastelera
plaque pâtissière



hitzebeständig bis 230°C
heat-resistant up to 230°C
resistente al calor hasta 230 °C
résistant à la chaleur jusqu'à 230°C

	cm	↑ cm	€
13377	40 x 25	2	7,60
13378	48 x 32	2	9,40
13379	60 x 40	2	12,00



Tablett „TREND“

baking sheet
bandeja
plateau



ein Backblech wird zum Serviertablett
a baking sheet which becomes a serving tray
una bandeja de hornear que se convierte en una bandeja de servir
un moule qui devient un plateau de service

	cm	↑ cm	€
13380	32,0 x 21,5	2	9,00



Rechteckschalen

container
cubeta
bac



	cm	↑ cm	ltr.	€
11941	30 x 21,0	6,5	2	4,00
11942	34 x 23,5	7,0	3	5,20
11943	48 x 33,0	8,0	8	11,00

**Mehlschaufel**

scoop
pala
pelle à farine



stehende Schaufel, auch für Flüssigkeiten geeignet

standing scoop, also applicable for liquids

pala, ápto también para líquidos

adaptée pour poudres et liquides

	cm	↑ cm	ltr.	Farbe / Colour	€
00610	25 x 9	4,5	0,25		2,30
00611	31 x 12	5,5	0,5		2,80
00612	35 x 13	6	0,7		4,10

**Seiher**

strainer
colador
passoire



mit 2 Muschelgriffen

with 2 shell shaped grips

con dos asas

à 2 anses moulées

	Ø cm	↑ cm	€
00780	36	19	9,40

**Backhandschuhe**

baking mittens
manoplas de panadero
gants de boulanger

Leder, gefüttert, Einheitsgröße, mit Stulpen, extrem hitzebeständig bis 250°C

leather, inner lining, one size, with cuffs, extremely heat resistant up to 250°C

cuero interior forrado, talla única, resiste a temperaturas hasta 250°C

cuir intérieur doublé, taille unique, résiste à maxi 250°C

	→ cm	€
88090	45	29,00

**Pizzaschaufel**

pizza peel
pala de pizza
pelle à pizza



	cm	→ cm	€
88080	35 x 30,5	90	34,00
88081	35 x 30,5	130	41,00



2 Pressringe für Zitrone und Limette

Limetten- / Zitronenpresse
lime- / lemonpress
exprimidor de limón / lima
presse citron



	cm	↑ cm	€
93214	21 x 7	5	13,00



Limettenpresse
lime press
prensa de limón
presse citron



	cm	↑ cm	€
93189	21 x 7	5	10,00



Zitruspresse
citrus squeezer
exprimidor cítricos
presse-citron



hochglanzpoliert, 2-teilig
mirror polished finish, 2 pcs.
pulido brillante, 2 piezas
brillant, 2 pièces

	Ø cm	↑ cm	ltr.	€
71431	12 / 17	10,5	0,35	12,90

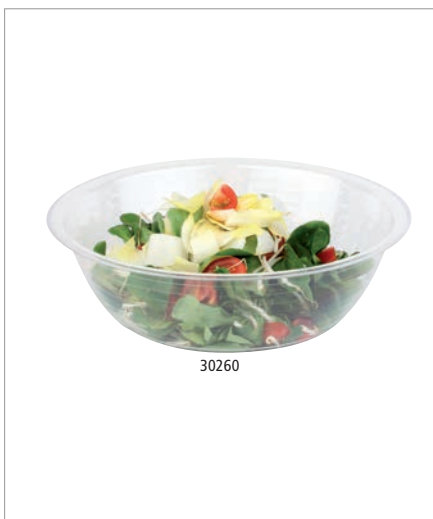

30260

Schüssel
bowl
ensaladera
saladier



	Ø cm	↑ cm	ltr.	Farbe / Colour	€
30260	32,5	10	4	White	4,70
30263	40	12	8	White	9,40
30266	47	14,5	14	White	14,70



77350

77352

Pinsel
brush
brocha
pinceau pâtissier



weißgebleichte, naphtalinfreie Borsten, temperaturbeständig von -40°C bis +95°C
bleached bristles, heat-resistant from -40°C to +95°C
cerdas blanqueadas, resistencia térmica -40°C hasta +95°C
soies blanchies sans naphtaline, résistance de - 40°C à + 95°C

	cm	→ cm	€
77350	4 x 1	23,5	6,20
77352	6 x 1	24	9,00



Vorratsglas „WOODY“

canister with lid
bote con tapa
pot en verre avec couvercle



Holzdeckel mit Silikondichtung
wooden lid with silicone gasket

GLAS GLASS
HOLZ WOOD
SILIKON SILICON

Glasbehälter mit Holzdeckel, aromadichter Verschluss

glass container, aroma-tight screw cap
recipiente de cristal, tapa con cierre hermético para conservar el aroma
récipient en verre, couvercle avec fermeture hermétique pour conserver l'arôme

	Ø cm	↑ cm	ltr.	€
82255	14 x 14	11,0	1,0	8,20
82256	14 x 14	17,0	2,0	8,60
82257	14 x 14	21,5	2,5	9,40



Vorratsglas „CLASSIC“

canister with lid
bote con tapa
pot en verre avec couvercle

GLAS GLASS
PE POLYETHYL

inkl. Glasdeckel mit Dichtung. Somit bleibt Ihre Ware frisch

incl. glass lid with seal. Thus, your goods remain fresh
incl. tapa de vidrio con junta. Por lo tanto, sus productos permanecen frescos
y compris couvercle en verre avec joint. Ainsi, vos marchandises restent fraîches.

	Ø cm	↑ cm	ltr.	€
82250	11,5	16,0	0,9	5,20
82251	14,0	21,5	2,0	9,40
82252	18,0	26,0	4,0	14,80
82253	20,0	30,0	6,0	17,20



2 ltr.

Vorratsglas mit luftdichtem Klappdeckel

glass with airtight cover
bote con cierre hermético
pot en verre avec fermeture hermétique



	cm	↑ cm	ltr.	€
82328	12 x 12	22	2	6,20



inkl. Löffel

3 ltr.

Vorratsglas

canister with lid
bote con tapa
pot en verre avec couvercle



Glaskugel mit Löffel, Schraubdeckel mit aromadichtem Verschluss, Edelstahl-Löffel mit magnetischem Silikongriff, 1 Stck.

tight cover, stainless steel spoon with magnetic silicone handle, 1 pc.
tapa a rosca con cierre hermético, cuchara de acero inoxidable con mango de silicona magnético, 1 pza
couvercle à vis avec fermeture hermétique, cuillère en acier inox avec manche de silicone aimanté, 1 pc.

	Ø cm	↑ cm	ltr.	€
00636	20	18	3	10,80



1 ltr.

Vorratsglas

canister with lid
bote con tapa
pot en verre avec couvercle



Glaskugel mit Schraubdeckel, aromadichtem Verschluss, 1 Stck.

glass ball, aroma-tight screw cap, 1 pc.
bote de cristal, tapa a rosca para conservar el aroma, 1 pza
pot en verre, couvercle à vis pour conserver l'arôme, 1 pc.

	cm	↑ cm	ltr.	€
00637	12,5 x 19	18	1	7,20



Bonspieß

bill spike
pinchanotas
pique-bons



Spieße aus flexiblen Kunststoff, mit stumpfen Enden zur Unfallverhütung
spikes made of flexible plastic, with blunt ends to prevent accidents
pinchos de plástico flexible
piques en plastique flexible

	cm	↑ cm	€
88855	9 x 5,5	10,5	3,20



Bonleiste

bill rail
portafichas
barre porte-bons



matt poliert, mit Kugel-Greifsystem, zur Wandmontage geeignet, auch mit Magneten nutzbar
satin polished finish, small balls hold the bills, suited for wall fastening, can also be used with magnets
acabado satinado, con sistema de bolas para colgar las notas para fijar en la pared, puede usarse con imán
mat satiné, avec billes pour fixer sans effort tous types de fiches et papiers, peut se fixer sur plaque aimantée

	cm	↑ cm	€
88900	40 x 8	2	16,00
88901	50 x 8	2	17,40
88902	60 x 8	2	18,90



Magnet-Messerhalter

magnetic knife rack
barra magnética para cuchillos
barre aimantée pour couteaux



mit 2 Magnetschienen und Haken, aus massivem Kunststoff, zur Wandmontage geeignet, Lieferung ohne Deko
with 2 magnet racks and hooks, strong plastic, suited for wall fastening
con 2 railes magnéticos y ganchos, plástico macizo, fijación en pared
avec 2 rails aimantés et crochets, plastique robuste, fixation murale

	→ cm	€
88911	45	10,20
88912	60	12,40



Folien-Abreißvorrichtung, mit Abreißkante / Säge

clingfilm tear-off-dispenser
dispensador de film
dérouleur de film



mit Abreißkante / Säge-Messer, für Endlosfolie, als Tischgerät oder Wandgerät verwendbar
with saw, for endless rolls, can be fixed on the wall
con sierra para rollo de film continuo, se puede fijar en la pared
avec lame dentée pour rouleau de film, peut être fixé au mur

	cm	↑ cm	€
88288	34 x 16	9	für Folienbreite 30 cm / for film width 30 cm para film ancho 30 cm / pour film largeur 30 cm 38,00
88287	49 x 16	9	für Folienbreite 45 cm / for film width 45 cm para film ancho 45 cm / pour film largeur 45 cm 42,00

**Schneidbrettständer**

cutting board rack
soporte para tablas
rack pour planches à découper



für 6 Schneidbretter bis 25 mm Stärke, Lieferung ohne Deko
for 6 chopping boards up to 25 mm thickness
para 6 tablas de corte de 25 mm
pour 6 planches de 25 mm

	cm	↑ cm	€
88903	27 x 31	28	30,00

**Eiswaffel-Ständer**

cornet stand
soporte cucuruchos
support à cornets



matt poliert, mit 4 Löchern, 2 x Ø 31 mm + 2 x Ø 26 mm
satin polished finish, with 4 holes, 2 x Ø 31 mm + 2 x Ø 26 mm
acero inoxidable con 4 agujeros 2 x Ø 31 mm + 2 x Ø 26 mm
inox, 4 trous - 2 x Ø 31 mm + 2 x Ø 26 mm

	cm	↑ cm	€
11881	9,5 x 27,5	9	18,50

**Eiswaffel-Ständer**

cornet stand
soporte cucuruchos
support à cornets



mit 4 Löchern, 2 x Ø 31 mm + 2 x Ø 26 mm
with 4 holes, 2 x Ø 31 mm + 2 x Ø 26 mm
con 4 agujeros, 2 x Ø 31 mm + 2 x Ø 26 mm
4 trous, 2 x Ø 31 mm + 2 x Ø 26 mm

	cm	↑ cm	€
11894	24,5 x 9,5	9	17,60

**Eisportionierer**

ice cream scoop
cuchara para helado
cuillère à glace



hochglanzpoliert, mit Edelstahlfeder (physikalisch bedingt nicht korrosionsbeständig)
mirror polished finish, spring steel, spring is not stainless
pulido brillante, muelle de acero especial, no resistente al óxido
poli brillante, ressort acier spécial, non résistant à l'oxydation

	Ø cm	→ cm	ltr.	€
71006	6,5	23,5	1/12	11,00



Quetschflasche „MINI“, 4er Set

squeeze bottle, 4 pcs.
bote dosificador flexible, 4 pz.
bouteille verseuse souple, 4 pc.



mit Schraubdeckel und Verschlusskappe, ideal zum Servieren von Dressing und Saucen
with tight-screw and cap, ideal for serving dressing and sauces
tapa de rosca, con tapón, ideal para servir aliño y salsas
bouchon à vis de étanche, avec bouchon, idéal pour servir de vinaigrette et sauces

	Ø cm	↑ cm	ltr.	pcs.	€
93225	3,0	8,5	0,03	4	4,80
93226	3,5	9,5	0,05	4	5,20



Quetschflasche

squeeze bottle
bote dosificador flexible
bouteille verseuse souple



ideale Größe, um Speiseteller mit Saucen zu verzieren, mit Verschlusskappe
ideal size to garnish plates with sauces, with cap
tamaño ideal para decorar los platos con salsas o culis, con tapón
taille idéale pour la décoration sur assiette avec sauces ou coulis, avec bouchon

	Ø cm	↑ cm	ltr.	€
93154	5	18	0,2	1,30
93163	5,5	19	0,35	2,10



Quetschflasche

squeeze bottle
bote dosificador flexible
bouteille verseuse souple



mit Verschlusskappe
with cap
con tapón
avec bouchon

	Ø cm	↑ cm	ltr.	Farbe / Colour	€
93155	6,5	25	0,65		1,70
93156	6,5	25	0,65		1,70
93157	6,5	25	0,65		1,70



Quetschflasche

squeeze bottle
bote dosificador flexible
bouteille verseuse souple

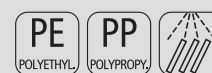

	Ø cm	↑ cm	ltr.	Farbe / Colour	€
93222	9,5	25,5	1,1		5,10
93223	9,5	25,5	1,1		5,10
93224	9,5	25,5	1,1		5,10



Dosierspender
dispenser
dispensador de salsa
doseur à sauce

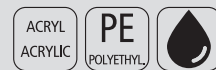

	cm	↑ cm	ltr.	€
93151	13 x 7,5	27	1,25	34,70
93150	11 x 11	27	1,35	34,70

Dosierpumpe
dosing pump / riser tube
bomba de salsa, sola
pompe à sauce



Hubvolumen 30 ml
swept volume 30 ml
cada dosis 30 ml
30 ml par dose

	Ø cm	↑ cm	€
88271	4,5	40	10,50



Gewürzkasten
condiment container
especiero
boîte à épices ou ingrédients



matt poliert, 4 herausnehmbare Einsatzschalen je 0,5 l, Scharnierdeckel aus Acryl
satin polished finish, 4 removable inserts each 0,5 ltr., acrylic lid
acabado mate, 4 contenedores extraíbles de 0,5 L cada uno, tapa con bisagras de acrílico
poli mat, 4 compartiments amovibles de 0,5 l chacun, couvercle rabattable en acrylique

	cm	↑ cm	ltr.	€
71700	31 x 15,5	9,5	4 x 0,5	23,00

Einsatzschale / insert / contenedor 0,5 L / récipient 0,5 L

	cm	↑ cm	ltr.	€
71701	14,2 x 7,5	7	0,5	3,90



Universalbox
universal box
caja dispensadora
boît distributrice



ideal für Zucker, Milch und Gebäck, 3 Fächer
best for sugar, milk and biscuits, 3 compartments
la perfecta solución para a zúcar, leche y galletas, 3 compartimentos
la solution idéale pour sucre, lait et biscuits, 3 compartiments

	cm	↑ cm	€
11886	41,5 x 20,5	16	29,00



Die Servierpfännchen aus emailiertem Gußeisen dienen dem portionsweisen Servieren und halten die Speisen warm.

The serving pans made of enamelled cast iron are used for serving in portions and for keeping the food warm.

Las fuentes de hierro fundido esmaltado se utilizan para servir en porciones y mantener la comida caliente.

Les plateaux de service en fonte émaillée sont utilisés pour servir en portions et garder les aliments au chaud.



Servierpfännchen „CAST IRON“
serving pan
fuente para servir
plat de service



Gusseisen emailiert
enamelled cast iron
hierro fundido esmaltado
fonte émaillée

	Ø cm	↑ cm	Farbe / Colour	€
88220	10	2		14,00
88225	10	2		14,00
88221	13	2		16,00
88226	13	2		16,00
	cm	↑ cm		€
88222	13 x 13	2		16,00
88227	13 x 13	2		16,00
88223	16 x 13	2		18,00
88228	16 x 13	2		18,00
88224	20 x 13	2		20,00
88229	20 x 13	2		20,00

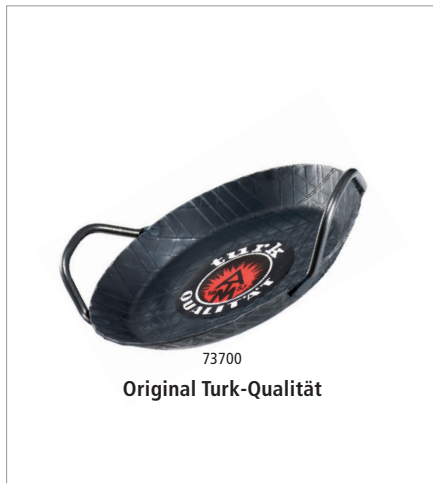

**schmiedeeiserne Servierpfanne**

pan wrought-iron
sartén forjada
poêle à frire forgée



mit zwei Griffen, hervorragende Brateigenschaft, Griffe und Stiele angeschweißt

with two welded handles, best bake properties, professional quality
con dos asas, excelentes propiedades de cocción, calidad profesional
2 anses, qualité professionnelle, excellente diffusion de chaleur, idéale pour la cuisson

	Ø cm	↑ cm	kg	€
73700	14 - 20	3	0,87	16,80
73701	17 - 24	3	1,15	19,30
73702	21 - 28	3,5	1,49	27,30
73703	24 - 32	3,5	1,85	41,90

**Korkuntersetzer**

cork mat
salvamanteles
dessous-de-plat liège



ideal für Servier- und Eisenpfannen

ideal for iron pan
ideal para servir en sartenes de chapa
idéal pour présenter les poêles forgées sur table

	Ø cm	↑ cm	€
73750	24	2	11,00

**schmiedeeiserne Servierpfanne**

wrought-iron pan
sartén forjada
poêle à frire forgée



mit geschmiedetem, angeschweißtem Hakenstiel, hervorragende Brateigenschaft

welded handle with hook, best bake properties, professional quality
mango soldado, con gancho al final, excelentes propiedades culinarias, calidad profesional
manche soudé à accrocher, qualité professionnelle, excellente diffusion de chaleur, idéale pour la cuisson sur tous feux, pour le four ou pour la table

	Ø cm	↑ cm	kg	€
73711	14 - 20	3	0,85	15,10
73712	17 - 24	3	1,17	17,90
73713	21 - 28	3	1,53	25,20
73714	24 - 32	3	1,99	37,80

**Eisenpfanne**

iron pan
sartén de chapa
poêle à frire lyonnaise



schwere Ausführung, mit angeschweißtem Hakenstiel, extra hoher Rand, für den professionellen Einsatz

heavy version, with flat welded handle with eye, extra high seam, professional quality
pesada, con mango plano, borde alto, para uso profesional
qualité lourde, manche plat, bord haut, pour usage professionnel

	Ø cm	↑ cm	kg	€
73740	17 - 24	4	1,45	17,60
73741	20,5 - 28	4,5	1,87	24,20
73742	23 - 32	5	2,41	29,10
73743	27 - 36	6	3,11	37,80



73502

hitzebeständig bis 600°C

Original Turk-Qualität

Pizzaform
 pizza dish
 molde de pizza
 moule à pizza



Blaublech, nicht beschichtet, lange Lebensdauer, zum professionellen Pizzabacken
 metal sheet, without coating, long endurance, baking pizza professional
 chapa azul, sin revestimiento, muy resistente, para uso profesional, larga duración
 métal, sans revêtement, très résistant, pour usage professionnel, très durable

	Ø cm	↑ cm	€
73502	18 - 16,2	2,5	2,60
73503	20 - 18,2	2,5	2,80
73504	22 - 20,2	2,5	3,10
73505	24 - 22,3	2,5	3,40
73506	26 - 24,3	2,5	3,60
73507	28 - 26,3	2,5	4,00
73508	30 - 28,3	2,5	4,60
73509	32 - 30,3	2,5	5,00
73510	36 - 34,3	2,5	5,90
73511	40 - 38,3	2,5	8,30
73513	50 - 48,4	2,5	12,70



Pizzaform
 pizza dish
 molde de pizza
 moule à pizza



Blaublech, rechteckig, Rand umgelegt, hitzebeständig bis 260°C
 blue steel baking sheet, rectangular
 chapa azul rectangular, borde plgado
 métal, rectangulaire, bord plié

	cm	↑ cm	€
88256	60 x 40	2,5	19,80



63 cm

30 cm

klappbar
folding

Aufsteller „ACHTUNG RUTSCHGEFAHR“
 stand
 letrero
 panneau



	cm	↑ cm	Farbe / Colour	€
71421	30 x 63	63	Yellow	6,60





www.ovarandao.pt

www.ovarandao.pt

www.ovarandao.pt

Hauben & Zubehör

covers & accessories
campanas & accesorios
cloches & accessoires

www.ovarandao.pt

www.ovarandao.pt

www.ovarandao.pt

www.ovarandao.pt

www.ovarandao.pt

www.ovarandao.pt



QUALITÄTSHAUBEN

11042
GN 1/1

11041
GN 1/2



11043
GN 1/3

11044
GN 2/4

11041
GN 1/2

11042
GN 1/1

GN Abdeckhaube

GN cover
GN cubierta
GN cloche



passend für GN Tablett, glasklarer Kunststoff, nahezu unzerbrechlich
suitable for GN trays, clear plastic, nearly unbreakable
apto para bandejas GN, plástico transparente, muy resistente a la rotura
pour bacs et plateaux GN, plastique transparent, très résistant à la casse

	cm	↑ cm	✂ mm	GN	€
11043	32,5 x 17,6	10,5	3	1/3	15,00
11044	53,0 x 16,2	10,5	3	2/4	20,00

	cm	↑ cm	✂ mm	GN	€
11041	32,5 x 26,5	9,5	3	1/2	20,00
11042	53,0 x 32,5	9,5	3	1/1	28,00



stapelbar
stackable



GN 1/1 Haube „HOCHSTAPLER“

GN 1/1 cover
GN 1/1 campana
GN 1/1 cloche



glasklarer Kunststoff, Tablett fixiert sich auf der Haube - kein Rutschen möglich, nahezu bruchfest
clear plastic, tray fixes itself on the cover and can not slip off, nearly unbreakable
plástico transparente, la bandeja se fija a la tapa para que no se deslice, muy resistente a la rotura
en plastique transparen, le plat se fixe sur le dessous de la cloche pour ne pas glisser, très résistant à la casse

	cm	↑ cm	GN	fits to	€
11305	53 x 32,5	9	1/1	11300, 11290, 11295	30,00



GN Kuppelhaube

GN cover
GN cúpula
GN cloche bombée

glasklarer Kunststoff, Griff verchromt
clear, chrome knob
transparente, asa cromada
transparente, anse chromée



	cm	↑ cm	GN		€
11021	33 x 28	17	1/2	geschlossen / totally closed cerrada / toalemt fermée	24,20
11022	33 x 28	17	1/2	mit Front-Ausschnitt / one long side cut out gran apertura frontal grande ouverture frontale	26,40
11026	54 x 33	20	1/1	geschlossen / totally closed cerrada / toalemt fermée	47,00
11027	54 x 33	20	1/1	mit Front-Ausschnitt / one long side cut out gran apertura frontal grande ouverture frontale	49,00
11028	54 x 33	20	1/1	mit seitlichem Ausschnitt one small side cut out pequeña apertura lateral petite ouverture latérale	49,00



stapelbar
stackable



GN Rolltophaube

GN rolltop cover
GN campana rolltop
GN cloche rolltop



patentiert, passend für GN-Behälter, -Tablets, etc., leichtgängig auf- und zuklappbar 90°
patented, suitable for GN trays, solid quality, 90° opening
patentada, para bandejas GN, apertura 90°
brevetée, pour plateaux GN, ouverture 90°

	cm	↑ cm	GN		€
11008	53,0 x 32,5	19	1/1	vergoldeter Griff / gold plated handle pomo dorado / bouton doré	59,90
11010	53,0 x 32,5	19	1/1	verchromter Griff / chrome plated handle pomo cromado / bouton chromé	59,90
12008	32,5 x 26,5	15	1/2	vergoldeter Griff / gold plated handle pomo dorado / bouton doré	54,20
12010	32,5 x 26,5	15	1/2	verchromter Griff / chrome plated handle pomo cromado / bouton chromé	54,20



GN 1/1 Rolltophaube „SUNDAY“

GN 1/1 rolltop cover
GN 1/1 campana rolltop
GN 1/1 cloche rolltop



Griff ABS verchromt, leichtgängig auf- und zuklappbar
handle chrome plated, easy to open and close
asa material ABS cromado, fácil de abrir y cerrar
poignée matériel ABS chrome, ouverture et fermeture faciles

	cm	↑ cm	GN		€
11016	53,0 x 32,5	19	1/1		62,00



GN 1/1 Rolltop-Haube

GN 1/1 rolltop cover
GN 1/1 campana abatible
GN 1/1 cloche basculante



verchromter Zinkdruckguss-Griff / chrome plated metal handle / mango cromado de fundición a presión de zinc / poignée en zinc moulé sous pression chromé

	cm	↑ cm	GN		€
11018	53,0 x 32,5	17	1/1		62,00



Rolltophaube „PURE“

rolltop cover
campana abatible
cloche basculante



verchromter Griff / chrome plated handle / pomo cromado / bouton chromé

	cm	↑ cm			€
09013	44 x 33,5	17			24,00



GN 1/1 Haube

GN 1/1 cover
GN 1/1 campana
GN 1/1 cloche



klappbar, passend für GN 1/1-Behälter, GN 1/1-Tablets, etc., nahezu bruchfest
suitable for GN 1/1 chafing dish, GN 1/1 trays, GN 1/1 pans
plegable, para cubetas GN 1/1, bandejas GN 1/1 etc., muy resistente a la rotura
pliable, pour bacs GN 1/1, plateaux GN 1/1 etc., très résistant à la casse



klappbar
adjustable

	cm	↑ cm	GN		€
11013	53,0 x 32,5	6	1/1		27,50



Rolltophaube
rolltop cover
campana abatible
cloche basculante



glasklarer Kunststoff, leichtgängig auf- und zuklappen 90°
solid quality, to be opened 90°
plástico transparente, apertura 90°
plastique transparent résistant, ouverture 90°

	Ø cm	↑ cm		€
18388	38	20	mit verchromtem Kugelgriff / with chrome plated handle con pomo cromado / avec bouton chromé	21,00
18387	38	20	mit vergoldetem Kugelgriff / gold plated handle pomo dorado / bouton doré	21,00
18380	50	26	mit verchromtem Zylindergriff / chrome plated handle pomo cromado / bouton chromé	54,00



Frischhalte-Haube
cover
campana
cloche bombée



glasklar, Griff verchromt, schwere, stabile Ausführung
transparent, chrome knob, heavy stable quality
transparente, asa cromada, alta estabilidad
transparente, anse chromée, très stable

	Ø cm	↑ cm	fits to	€
15350	16,5	10	15130	8,90
15351	20,5	10	15131, 15141, 15136, 15271, 84241	9,90





Frischhalte-Haube

cover
campana
cloche



schwere, glasklare Qualität
stable, crystal clear quality
calidad estable y transparencia cristalina
qualité stable et clarté cristalline

	Ø cm	↑ cm	fits to	€
06519 <small>NEW</small>	21	17	84941, 84942	24,00
06520	30	22	85034, 84242, 84177, 83891, 83890, 83884, 15303, 998, 975, 469, 468, 463, 462 46,	29,90
06521 <small>NEW</small>	36	27	84945, 84946	56,00



stapelbar
stackable



Frischhalte-Haube

cover
campana
cloche



glasklar, schwere stabile Ausführung, stapelbar
clear, heavy stable quality, stackable
transparente, alta estabilidad, apilable
transparente, très stable, empilable

	Ø cm	↑ cm		€
06510	30	11,5		4,40
06512	30	11,5	mit verchromtem Griff / with chrom plated handle con botón cromado / avec bouton chromé	6,20



Frischhalte-Haube

cover
campana
cloche



glasklar, schwere stabile Ausführung, stapelbar
clear, heavy stable quality, stackable
transparente, alta estabilidad, apilable
transparente, très stable, empilable

	Ø cm	↑ cm		€
06515	33	12,5		5,50
06517	33	12,5	mit verchromtem Griff / with chrom plated handle con botón cromado / avec bouton chromé	6,90



Frischhalte-Haube

cover
campana
cloche



	Ø cm	↑ cm		€
06501	30	11		3,20
06504	30	9,5		4,90
06506	30	7		3,10



Frischhaltehauben, 2er Set

covers, 2 pcs. set
campanas, set de 2
cloches, pack de 2



	Ø cm	↑ cm	€
40752	30	11	6,20



Deckel „FLOAT“ mit Löffelaussparung

cover, with notched for spoons
tapa, con espacio para la cuchara
couvre-cle, avec encoche pour la louche



	Ø cm	↑ cm	fits to	€
83920	20,5	1,3	83908, 83909	8,20



Deckel „FLOAT“ mit Löffelaussparung

cover, with notched for spoons
tapa, con espacio para la cuchara
couvre-cle, avec encoche pour la louche



	cm	↑ cm	fits to	€
83921	19 x 19	1,3	83916, 83917	8,20
83922	25 x 25	1,3	83918, 83919	10,40



Deckel „PURE“ mit Löffelaussparung

cover with notched for spoons
tapa con espacio para la cuchara
couvre-cle avec encoche pour la louche



	cm	↑ cm	fits to bowls	€
83600	19 x 19	1,5	84410, 84417, 84422, 83409, 83572, 84468, 83573, 84429, 84244	8,00
83601	25 x 25	1,5	84408, 84418, 84423, 83469, 83574, 83575, 83408, 84430, 84245, 84561, 84562, 84563	10,50
83602	32 x 32	1,5	84425, 84427	12,00



stapelbar
stackable



10890

Frischhaltedeckel
airtight cover
tapa hermética
couvercle hermétique



mit Silikondichtung, für luftdichtes Verschließen, Lebensmittel bleiben lange frisch
with silicone sealing ring, bowls closed airtight, to keep food fresh for a long time
junta de silicona para cerrar herméticamente y mantener los alimentos frescos más tiempo
joint de silicone pour fermeture hermétique et meilleure conservation des aliments

	Ø cm	fits to	€
10890	14	11865, 83700, 83701	10,50
10887	23	11875, 11846, 11848, 83702, 83703	19,00



zwei Öffnungspositionen des Deckels
two opening positions of the lid



11868

11878

Schutzdeckel mit Löffelaussparung
cover
tapa
couvercle



glasklar, klappbar, mit 10 Beschriftungs-Schildern
transparent, with 10 cards for inscription
plástico transparente, con 10 etiquetas para inscripción
plastique transparent, avec 10 étiquettes pour inscription

	Ø cm		€
11868	14,5	mit verchromtem Griff / chrome plated handle botón cromado / bouton chromé	10,40
11878	23,5	mit verchromtem Griff / chrome plated handle botón cromado / bouton chromé	11,40

Schilder, 10er Set / signs, 10 pcs. set / set de 10 cartelitos / set de 10 étiquettes

	fits to	€
12879	11867, 11868	4,60
11879	11877, 11878	4,90



Deckel klappbar mit Löffelaussparung
cover hinged
tapa con bisagra
couvercle avec charnière



glasklar, mit Designer-Griff, verchromt, ohne Beschriftungsschild
clear, with designer handle, chrome plated, without card for inscription
transparente, con pomo de diseño cromado, sin tarjetas para inscripción
transparent, avec bouton chromé de design, sans étiquette pour inscription

	Ø cm	€
10889	23,5	10,50



11875

Schale
bowl
cuenco
bol



	Ø cm	↑ cm	ltr.	pcs	€ / pc.
11875	23,0	10,5	2,50	6	4,20
11865	14,0	6,5	0,50	6	2,20
11866	7,5	3,5	0,09	36	1,40
11859	6,0	2,5	0,05	36	1,30



Kühlakku

cooler
 acumulador de frío
 accumulateur de froid



gefüllt mit Kühlflüssigkeit, nicht giftig, einfach im Gefrierfach einfrieren, unbegrenzt wiederverwendbar
 freeze it in freezer, non toxic, filled with freezer-liquid, boundless reusable
 se enfría en el congelador, no tóxico, se puede reutilizar sin límite
 liquide eutectique qui accumule froid une fois dans le congélateur, non toxique, réutilisable sans limites

	Ø cm	↑ cm	Farbe / Colour	€
10777	15	2,5		5,00
10781	10,5	2,5		3,00
10661	10,5	2,0		3,20
10752	10,5	2,0		4,60

white and black



Kühlakku

cooler
 acumulador de frío
 accumulateur de froid



gefüllt mit Kühlflüssigkeit, nicht giftig, einfach im Gefrierfach einfrieren, unbegrenzt wiederverwendbar
 freeze it in freezer, non toxic, filled with freezer-liquid, boundless reusable
 se enfría en el congelador, no tóxico, se puede reutilizar sin límite
 liquide eutectique qui accumule froid une fois dans le congélateur, non toxique, réutilisable sans limites

	cm	↑ cm	Farbe / Colour	€
10782	41 x 21	2,5		14,20
10791	25 x 19	2,5		7,20
11101	16 x 7,5	2,0		4,70



Aufsteller „ACHTUNG RUTSCHGEFAHR“

stand
 letrero
 panneau



	cm	↑ cm	Farbe / Colour	€
71421	30 x 63	63		6,60

Laserlogo Individual

perfekte Lasergravuren
perfectly Laser engravings
grabado perfecto por láser
marcage laser parfait



Unverwechselbar - Einzigartig - Imagefördernd Ihre individuelle Lasergravur von APS

Wir bieten Ihnen die Möglichkeit, unsere Produkte mit Ihrem individuellen Logo per Laser zu gravieren - einzigartig, unverwechselbar und bereits ab 10 Stück je Artikel. Die perfekte Beschriftung durch modernste Lasertechnologie ist spülmaschinenfest und somit dauerhaft auf allen Edelstahl- und Naturschieferprodukten, sowie auf versilberten und verchromten Metall-Artikeln umsetzbar. Machen Sie aus Ihren Gastrom-Behältern Ihre ganz persönlichen Unikate und werten Sie Ihre Servierartikel mit Ihrem eigenen Logo auf.

- geringe Mindestbestellmenge von nur 10 Stück
- kurze Lieferzeiten
- Logos bis zu einer Fläche von max. 10 x 10 cm realisierbar

Distinct - Unique - Image enhancing Your individualised laser engraving by APS

We offer you the option of having your personalised logo engraved on our products - inimitable, unique, and available for delivery from only 10 pieces per product. The perfect inscription by use of the newest technology is dishwasher-safe and thus can be permanently applied to products made of stainless steel and natural slate, as well as silver-coated and chromed metal articles. Turn your gastrom container into your individual, one of a kind article and enhance your serving items with your own logo.

- minimum order quantity of only 10 pieces
- swift delivery
- feasible logos are those with a maximum size of 10 x 10 cm

Único, personalizado, promotor de imagen Grabado laser por APS

Podemos grabar su logo y así personalizar los productos APS a partir de mínimo 10 unidades por referencia.

Gracias a la novedosa tecnología de grabado por láser, la inscripción es perfecta y resistente al lavavajillas. Se puede aplicar a los artículos en acero inoxidable, pizarra natural, metal cromado y plateado.

- Cantidad mínima de solamente 10 unidades
- Realización rápida
- Tamaño de logos hasta máximo 10 x 10 cm

















Unique, original, porteur d'image Marcage laser par APS

Nous pouvons graver votre logo et ainsi personnaliser les produits APS à partir de 10 pièces par référence.

Grâce à une technologie d'avant-garde de marcage par laser, l'inscription est parfaitement reproduite et résistante au lave-vaisselle. Ce type de marcage peut s'appliquer sur l'acier inoxydable, sur l'ardoise naturelle, sur le métal chromé ou argenté.

- Quantité minimum de seulement 10 unités
- Fabrication rapide
- Taille du logo jusque 10 x 10 cm

Icon-Index / Material-Index

 neuer Artikel new item	 spülmaschinengeeignet dishwasher-proof	 für Induktionsplatten for induction use
 niedriger Preis hot price	 nicht spülmaschinengeeignet not dishwasher-proof	 kühlbar for cooling
 Made in Germany	 abwaschbar / wasserfest water-proof	 doppelwandig double wall
 GN-Größen GN norm	 mikrowellengeeignet microwave-proof	 bruchsicher shatter-proof
 stapelbar stackable	 nicht mikrowellengeeignet not microwave-proof	 Eigenmontage self assembly
 Antirutsch-Füßchen non-slip feet	 keine direkte Hitze not direct heat	 für Lebensmittelkontakt food safe
 Inhaltsangabe volume	 nicht für Backofen not for baking oven	 nicht für Lebensmittelkontakt non food safe

APS - BSCI-Mitglied

APS engagiert sich für die Verbesserung von Arbeitsbedingungen.

Wir sind Partner der europäischen Organisation BSCI. Die "Business Social Compliance Initiative" (BSCI) ist eine Initiative von Unternehmen zur Verbesserung der Arbeitsbedingungen in der globalen Versorgungskette.

APS is a member of BSCI

APS is committed to the improvement of working conditions.

We are a partner of the European organization BSCI. The "Business Social Compliance Initiative" is an initiative of enterprises to improve working conditions in the global supply chain.



APS Melamin - Garantierte Qualität

APS-Melaminprodukte entsprechen den Richtlinien (EG) 1935/2004 und (EU) 10/2011 der Europäischen Kommission. Diese enthalten Bestimmungen für Materialien aus Kunststoffen, welche mit Lebensmitteln in Berührung kommen. Wir arbeiten sehr eng mit den Zertifizierungsinstitutionen Intertek und TÜV zusammen und können somit die Lebensmittelsicherheit (LFGB Regulation) der APS-Melaminartikel garantieren.

APS Melamine - Guaranteed quality

APS melamine products comply with directives (EG) 1935/2004 and (EU) 10/2011 of the European Commission. This contain provisions for plastic materials which come into contact with foodstuffs. We work very closely together with the certification institutions Intertek and TÜV and are therefore able to guarantee the compatibility with foodstuffs (German LFGB regulation) of APS melamine.

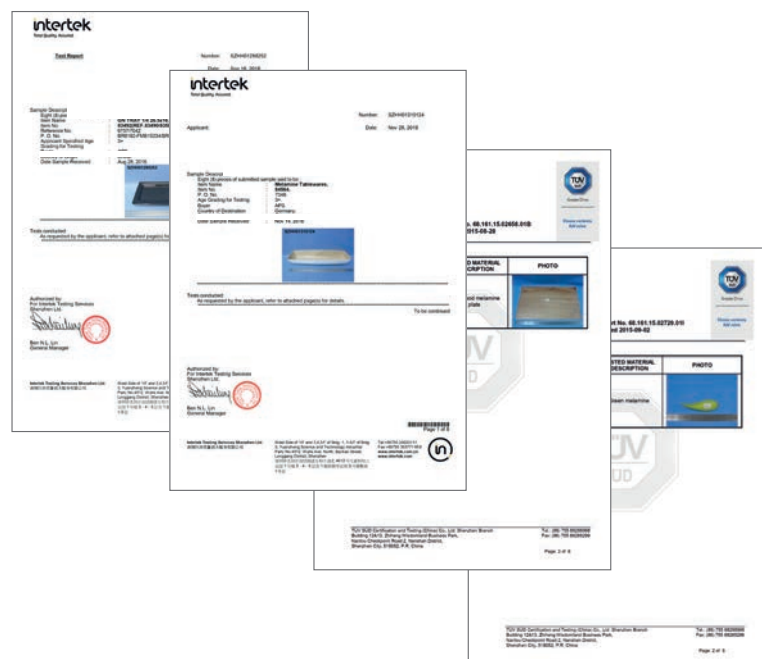

**Edelstahl 18/10 / Stainless steel 18/10**

Werkstoff 1.4301; rostfrei; langlebig; gute isolierende Eigenschaften; absolut hygienisch und nicht toxisch; recyclebar; nicht resistent gegen dauerhaften Kontakt mit Chloriden und Säuren (z. B. Kochsalz und Fruchtsäuren); sterilisierbar; Oberfläche lässt sich vielfältig polieren; nicht magnetisch; Gebrauchstemperatur bis ca. 400 °C

Pflege: pflegeleicht; maschinell oder per Hand mit milden Spülmitteln; möglichst keine Stahlwolle u. ä. verwenden; nach Erhitzung Schockabkühlung vermeiden

**Edelstahl (unspezif.) / Stainless steel (unspecific)**

niedrig nickelhaltige Edelstähle wie 14/4; nicht magnetisch; geringere allgemeine Resistenz als Edelstahl 18/10; Pflege: s. Edelstahl 18/10

**Edelstahl 18/0 / Stainless steel 18/0**

Werkstoff 1.4016; rostfrei; langlebig bei entsprechender Pflege; absolut hygienisch und nicht toxisch; gut härtbar, daher idealer Stahl für Tafelmesser, Tablett, Schneidewerkzeuge u. ä.; lässt sich hochglanzpolieren; für Nickelallergiker geeignet; magnetisch; nicht so chemikalienresistent wie Edelstahl 18/10; Gebrauchstemperatur bis ca. 400 °C

Pflege: maschinell oder per Hand mit milden Spülmitteln; Ablagerungen von Kalk und Reinigerresten nach dem Spülen unbedingt entfernen; niemals mit Stahlwolle reinigen

**Eisen / Iron**

nicht rostfrei; charakteristische, strukturierte Oberfläche mit unterschiedlichen Schattierungen; durch wiederholten Schmiedevorgang ist das Material stark verdichtet und sehr hart; langlebig bei entsprechender Pflege, Pflege: vor erstem Einsatz mit Öl und Kartoffelschalen „einbraten“; später nach jeder Reinigung einfeuten; stets trocken lagern

**Gusseisen / Cast Iron**

langlebig bei entsprechender Pflege; geeignet für alle Herdarten (inkl. Induktion); speichert lange Wärme und gibt sie gleichmäßig ab; absolut hygienisch bei unbeschädigter Oberfläche; relativ schweres Material; Überhitzung fast nicht möglich; nicht schlagfest; magnetisch, Pflege: nach Gebrauch sofort mit heißem Wasser reinigen; bei Fleckenbildung mit Essig nachreinigen; niemals mit Stahlwolle reinigen; milde Spülmittel verwenden; stets trocken lagern

**Versilberter Stahl / Silver plated steel**

Edelmetallüberzug; nicht völlig säurefest; nicht über längere Zeit Sonnenlicht aussetzen

Pflege: niemals scheuernde Hilfsmittel verwenden; nur mit weichem Lappen und Spezialmitteln reinigen; keine Spülmaschinenreinigung!

**Verchromter Stahl / Chrome plated steel**

nichtedles Metall mit hartem Chromüberzug; nicht säurefest; nach Beschädigung der Chromschicht kein Schutz gegen Umwelteinflüsse

Pflege: niemals scheuernde Hilfsmittel verwenden; nur mit weichem Lappen

**Aluminium**

sehr leichtes Material; sehr gute elektrische und thermische Leitfähigkeit; korrosionsbeständig; nicht spülmaschinengeeignet; Gebrauchstemperatur bis ca. +500 °C

**Porzellan**

spülmaschinengeeignet; hitzebeständig bis ca. +220 °C

**GFK – Glasfaserverstärkter Kunststoff**

starr; nahezu unzerbrechlich; spülmaschinengeeignet; Gebrauchstemperatur bis ca. +100 °C

**ABS – Acrylnitril-Butadien-Styrol**

sehr gute Oberflächenhärte; temperaturwechselfest; spülmaschinengeeignet; Gebrauchstemperatur bis ca. +100 °C

**ACRYL – künstliches Harz**

farblos; glasartig; durchsichtig; nicht splitternd; chemisch modifiziert als Plexiglas®; wichtiger Pflegehinweis: nur handelsübliche Acrylspezialreiniger oder milde alkohol- und ammoniakfreie Reinigungsmittel verwenden; nicht spülmaschinengeeignet; Gebrauchstemperatur ca. -40 °C bis ca. +50 °C

**EVA - Ethylvinylacetat**

weich elastisch; glänzend; abwaschbar / wasserfest

Gebrauchstemperatur bis ca. +60 °C

**MF - Melamin**

sehr hart; stoß- und kratzfest; hygienisch; säurebeständig; spülmaschinengeeignet; Gebrauchstemp. ca. -30 °C bis +70 °C

**MS - Kunststoff**

farblos; glasartig; durchsichtig; nicht spülmaschinengeeignet; Gebrauchstemperatur ca. 0 °C bis ca. +70 °C

**PA - Polyamid**

starr; bruch- und schlagfest; mattglänzend; spülmaschinengeeignet; Gebrauchstemperatur bis ca. +220 °C

**PC - Polycarbonat**

starr; nahezu unzerbrechlich; sehr stabil; formbeständig in kochendem Wasser; spülmaschinengeeignet; mikrowellengeeignet; Gebrauchstemperatur ca. -30 °C bis ca. +100 °C

**PE - Polyethylen****HDPE – hochdichtes Polyethylen**

hart elastisch; unzerbrechlich; ausreichend formbeständig in heißem Wasser; glänzend; spülmaschinengeeignet; Gebrauchstemperatur ca. -40 °C bis ca. +120 °C

NDPE – niederdichtes Polyethylen

weich elastisch; unzerbrechlich; kurzzeitig formbeständig in heißem Wasser; nicht glänzend; spülmaschinengeeignet; Gebrauchstemperatur ca. -40 °C bis ca. +95 °C

**PP - Polypropylen**

hart elastisch; unzerbrechlich; umweltschonend recyclebar; spülmaschinengeeignet; mikrowellengeeignet; Gebrauchstemperatur ca. -30 °C bis ca. +75 °C

**PS - Polystyrol**

starr; kratzfest; formbeständig in kochendem Wasser; nicht spülmaschinengeeignet; Gebrauchstemperatur bis ca. +70 °C

**PVC - Polyvinylchlorid**

säurebeständig; schwer entflammbar; nicht spülmaschinengeeignet; Gebrauchstemperatur ca. -50 °C bis ca. +60 °C

**SAN - Styrol-Acrylnitril**

gute Oberflächenhärte; temperaturwechselfest; spülmaschinengeeignet; Gebrauchstemperatur bis ca. +100 °C

**Silikon**

hohe thermische Beständigkeit; gute Kälteflexibilität; spülmaschinengeeignet; Gebrauchstemp. ca. -70 °C bis ca. +180 °C

**Tritan®**

starr; unzerbrechlich; absolut formbeständig; sehr hohe Chemikalienbeständigkeit; spülmaschinenfest; Gebrauchstemperatur ca. -30 °C bis ca. +95 °C; nicht mikrowellengeeignet

**Schiefer®**

Naturschiefer versiegelt; lebensmittelecht; nicht spülmaschinengeeignet;

**Beton®**

Werkstoff Beton, coole optik; nicht spülmaschinengeeignet; handgefertigt

**Tetron**

Maschinenwaschbar bis 30 grad, 65% Polyester, 35% Viskose